

BIRA • IASB 1964 • 2014



50 YEARS OF RESEARCH
AT THE BELGIAN INSTITUTE
FOR SPACE AERONOMY



BIRA • IASB 1964 • 2014



50 YEARS OF RESEARCH
AT THE BELGIAN INSTITUTE
FOR SPACE AERONOMY

EDITORIAL BOARD

Direction Board

Martine De Mazière, Johan De Keyser and Didier Fussen

Scientific Board

Crist Amelynck, Christine Bingen, Simon Chabrilat,
Frank Daerden, Johan De Keyser, Martine De Mazière,
Didier Fussen, Michel Kruglanski, Karolien Lefever,
Didier Moreau, Jean-François Müller, Eddy Neefs,
Viviane Pierrard, Paul C. Simon, Michel Van Roozendael
and Ann Carine Vandaele.

Editorial Support

Stéphanie Fratta, Sophie Robyns, Umar Sayyed
and Tim Somers

Responsible Editor

Belgisch Instituut voor Ruimte-Aeronomie -
Institut d'Aéronomie Spatiale de Belgique (BIRA-IASB)

FOREWORD

This book was written on the occasion of the 50th anniversary of the Belgisch Instituut voor Ruimte-Aeronomie - Institut d'Aéronomie Spatiale de Belgique (BIRA-IASB). It is intended to present a large part of the scientific studies carried out during 50 years at BIRA-IASB. This is neither an exhaustive activity report nor a scientific textbook on aeronomy.

The addressed topics illustrate the historical evolution of scientific researches in the field of aeronomy since its infancy, in the sixties. Only a minority of topics is not reported.

Special thanks go to all external authors:

Guy Brasseur, Dirk Frimout, Ghislain Grégoire, William A. Lahoz, Marie-Claude Limbourg and Jean-Pierre Pommereau.

Their affiliation is mentioned explicitly in the book. All other authors and contributors are from BIRA-IASB or have been working there until their retirement. The authors are responsible for the content of their chapters and sections..

BIRA-IASB gratefully acknowledges the financial support received for this publication from the Federal Public Planning Service Science Policy, also known as Belgian Science Policy (BELSPO).



TABLE OF CONTENTS

FOREWORD		3
1. PREFACE	Dirk Frimout	12
2. SPACE AERONOMY: A HISTORICAL INTRODUCTION	Paul C. Simon	18
3. THE SUN AND THE EARTH'S ENVIRONMENT	Paul C. Simon	32
INTRODUCTION	Paul C. Simon, Viviane Pierrard and Joseph Lemaire	34
THE SUN	Paul C. Simon	35
ULTRAVIOLET SOLAR IRRADIANCE AND ATMOSPHERIC PROCESSES	Paul C. Simon	38
SOLAR ULTRAVIOLET IRRADIANCE VARIABILITY	Paul C. Simon	40
SOLAR WIND	Viviane Pierrard and Joseph Lemaire	42
4. THE MAGNETOSPHERE: FROM FIRST DISCOVERIES TO CURRENT RESEARCH	Johan De Keyser	46
INTRODUCTION	Johan De Keyser	48
THE MAGNETOSPHERE	Johan De Keyser	49
THE PLASMASPHERE	Joseph Lemaire and Viviane Pierrard	52
THE IONOSPHERE AND ITS COUPLING TO THE MAGNETOSPHERE	Johan De Keyser and Michel Roth	56
ENERGETIC PARTICLES IN SPACE	Norma Crosby	62
5. FROM THE UPPER ATMOSPHERE TO THE TROPOSPHERE: THEORIES AND MODELS	Jean-François Müller and Simon Chabrilat	66
INTRODUCTION	Simon Chabrilat and Guy Brasseur (MPI-M, NCAR)	68
THE UPPER ATMOSPHERE: THE REALM OF SATELLITES	Simon Chabrilat, Guy Brasseur (MPI-M, NCAR) and Paul C. Simon	72

THE MESOSPHERE AND LOWER THERMOSPHERE: TRANSITION REGIONS AND CURRENT RESEARCH	Simon Chabrilat and Guy Brasseur (MPI-M, NCAR)	75
THEORETICAL AND MODELLING STUDIES OF THE STRATOSPHERE	Sébastien Viscardy and Quentin Errera	78
TROPOSPHERIC MODELLING	Jean-François Müller and Trisseygeni Stavrou	82
6. BALLOON OBSERVATIONS	Crist Amelynck and Paul C. Simon	86
INTRODUCTION	Jean-Pierre Pommereau (LATMOS)	88
SOLAR ULTRAVIOLET RADIATION	Paul C. Simon	91
INFRARED REMOTE SENSING FROM STRATOSPHERIC BALLOONS	Christian Muller	93
BALLOON INTERCOMPARISON CAMPAIGNS	Jean-Pierre Pommereau (LATMOS) and Paul C. Simon	96
MASS SPECTROMETRY	Crist Amelynck and Niels Schoon	99
7. FIRST ORBITAL OBSERVATIONS	Paul C. Simon	102
SPACELAB 1 AND ATMOSPHERIC LABORATORY FOR APPLICATIONS AND SCIENCE MISSIONS	Paul C. Simon	104
THE GRILLE SPECTROMETER	Christian Muller	107
THE SOLAR SPECTRUM EXPERIMENT	Paul C. Simon and Didier Gillotay	109
INVESTIGATION OF ATMOSPHERIC HYDROGEN AND DEUTERIUM THROUGH MEASUREMENT OF LYMAN-ALPHA EMISSION	Paul C. Simon	112
THE EUROPEAN RETRIEVABLE CARRIER	Paul C. Simon	114
REMOTE SENSING OF THE EARTH'S ATMOSPHERE BY THE SPACEBORNE OCCULTATION RADIOMETER	Didier Fussen and Filip Vanhellemont	115
THE SOLAR SPECTRUM INSTRUMENT ON BOARD EURECA	Paul C. Simon	117
8. SATELLITE OBSERVATIONS	Paul C. Simon	118
INTRODUCTION	Paul C. Simon	120
THE GLOBAL OZONE MONITORING EXPERIMENT	Jean-Christopher Lambert and Paul C. Simon	125

THE ENVIRONMENTAL SATELLITE		129
THE SCANNING IMAGING ABSORPTION SPECTROMETER FOR ATMOSPHERIC CHARTOGRAPHY: 10 YEAR MEASUREMENTS OF OUR CHANGING ATMOSPHERE	Jean-Christopher Lambert	131
GLOBAL OZONE MONITORING BY OCCULTATION OF STARS ON BOARD ENVISAT: 10 YEARS OF STELLAR OCCULTATIONS	Didier Fussen, Filip Vanhellemont and Cédric Tétard	133
THE GLOBAL OZONE MONITORING EXPERIMENT-2 ON BOARD METOP: GLOBAL MONITORING OF TOTAL OZONE AND THE TROPOSPHERIC COMPOSITION	Michel Van Roozendael	136
THE INFRARED ATMOSPHERIC SOUNDING INTERFEROMETER	Sophie Vandenbussche and Evelyn De Wachter	138
MULTI-SPACECRAFT EXPLORATION OF THE MAGNETOSPHERE WITH CLUSTER	Johan De Keyser	140
THE SOLAR SPECTRUM EXPERIMENT ON BOARD THE INTERNATIONAL SPACE STATION	David Bolsée and William Peetermans	143
THE ATMOSPHERIC CHEMISTRY EXPERIMENT	Martine De Mazière and Didier Fussen	145
THE ENERGETIC PARTICLE TELESCOPE INSTRUMENT	Viviane Pierrard and Ghislain Grégoire (UCL)	147
THE ATMOSPHERIC LIMB TRACKER FOR THE INVESTIGATION OF THE UPCOMING STRATOSPHERE MISSION: THE FIRST BELGIAN SOUNDER OF THE EARTH ATMOSPHERE	Didier Fussen, Emmanuel Dekemper, Didier Pieroux, and Filip Vanhellemont	150
THE PICOSATELLITE FOR ATMOSPHERIC AND SPACE SCIENCE OBSERVATIONS MISSION: TOWARD GEOPHYSICAL MEASUREMENTS FROM MINIATURIZED SPACE SENSORS	Didier Fussen, Didier Pieroux, Sylvain Ranvier and Johan De Keyser	153
9. THE ENDANGERED OZONE LAYER		
INTRODUCTION	Paul C. Simon	156
THE SUPERSONIC AIRCRAFT THREAT TO THE OZONE LAYER	Guy Brasseur (MPI-M, NCAR) and Paul C. Simon	158
THE HALOCARBON THREAT AND POLAR OZONE	Christian Muller	161
OZONE AND CLIMATE CHANGES	Paul C. Simon	163
	Martine De Mazière	168

10. GROUND-BASED AND IN SITU OBSERVATIONS		
INTRODUCTION	Martine De Mazière and Michel Van Roozendael	170
THE NETWORK FOR THE DETECTION OF ATMOSPHERIC COMPOSITION CHANGE	Martine De Mazière, Michel Van Roozendael, Crist Amelynck and Hervé Lamy	172
THE TOTAL CARBON COLUMN OBSERVING NETWORK	Martine De Mazière and Filip Desmet	174
THE BELGIAN SOLAR UV-VISIBLE MONITORING NETWORK	Didier Gillotay	181
TROPOSPHERIC TRACE GAS MONITORING USING MAXDOAS	Michel Van Roozendael and François Hendrick	184
BIOGENIC VOLATILE ORGANIC COMPOUNDS	Crist Amelynck and Niels Schoon	186
SATELLITE VALIDATION	Jean-Christopher Lambert	189
BELGIAN RADIO METEOR STATIONS	Hervé Lamy	192
MAPPING AIR QUALITY FROM AN UNMANNED AERIAL VEHICLE	Alexis Merlaud and Michel Van Roozendael	194
11. LABORATORY STUDIES		
INTRODUCTION	Ann Carine Vandaele and Crist Amelynck	198
MOLECULAR OXYGEN ABSORPTION CROSS SECTION BETWEEN 175 AND 205 NM	Ann Carine Vandaele and Crist Amelynck	200
HALOCARBONS ABSORPTION CROSS SECTIONS	Paul C. Simon	202
ATMOSPHERIC TRACE CONSTITUENTS	Didier Gillotay and Paul C. Simon	203
CHEMICAL IONIZATION STUDIES OF ATMOSPHERIC COMPOUNDS	Ann Carine Vandaele and Christian Hermans	206
	Crist Amelynck and Niels Schoon	208
12. AEROSOLS, FROM PIONEERING WORK TO GLOBAL SURVEY		
INTRODUCTION	Christine Bingen	211
AEROSOL BALLOON FLIGHTS	Christine Bingen	212
STRATOSPHERIC SATELLITE OBSERVATIONS: OCCULTATION AND IMAGING INSTRUMENTS	Christian Muller and Christine Bingen	214
	Filip Vanhellemont	217

TWILIGHT OBSERVATIONS	Nina Mateshvili	221
CHARACTERIZATION OF STRATOSPHERIC AEROSOLS	Christine Bingen and Christian Muller	224
TROPOSPHERIC REMOTE SENSING OBSERVATIONS BY INFRARED ATMOSPHERIC SOUNDING INTERFEROMETER	Sophie Vandenbussche	227
<hr/>		
13. PLANETARY ATMOSPHERES	Ann Carine Vandaele and Frank Daerden	230
INTRODUCTION	Ann Carine Vandaele and Frank Daerden	232
THE PHOBOS OBSERVATIONS	Christian Muller	234
MARTIAN ATMOSPHERE EXPLORATION WITH MARS EXPRESS	Nina Mateshvili and Eddy Neefs	236
VENUS ATMOSPHERE EXPLORATION WITH VENUS EXPRESS	Ann Carine Vandaele and Eddy Neefs	239
NADIR AND OCCULTATION FOR MARS DISCOVERY AND EXOMARS	Ann Carine Vandaele and Eddy Neefs	243
REMOTE SENSING OF AEROSOLS ON MARS AND VENUS	Valérie Wilquet	245
MODELLING OF PLANETARY ATMOSPHERES	Frank Daerden	247
MASS SPECTROMETRY ON ROSETTA	Johan De Keyser and Frederik Dhooghe	249
<hr/>		
14. SCIENCE AND APPLICATIONS	Michel Kruglanski	252
SATELLITE TRAJECTORY FORECASTING	Paul C. Simon	254
SPACE WEATHER	Michel Kruglanski and Neophytos Messios	256
CHEMICAL DATA ASSIMILATION	Quentin Errera, William A. Lahoz (NILU) and Simon Chabrilat	260
DETECTION OF VOLCANIC ERUPTIONS	Nicolas Theys and Hugues Brenot	263
<hr/>		
15. TECHNICAL SUPPORT AND EXPERTISE	Eddy Neefs, Jeroen Maes, Sophie Berkenbosch, and Johan Bulcke	266
INTRODUCTION	Eddy Neefs and Johan Bulcke	268
INFORMATION TECHNOLOGY	Johan Bulcke	269

ELECTRONICS, SOFTWARE AND FIRMWARE DEVELOPMENT	Eddy Neefs, Sophie Berkenbosch and Dennis Nevejans	272
MECHANICAL DESIGN AND CONSTRUCTION	Eddy Neefs, Jeroen Maes, Sophie Berkenbosch, Emiel Van Ransbeeck and Dennis Nevejans	274
IMPORTANT CONTRIBUTIONS TO SCIENCE INSTRUMENTATION	Eddy Neefs, Jeroen Maes and Sophie Berkenbosch	275
<hr/>		
16. SPACE OPERATIONS AND KNOWLEDGE MANAGEMENT	Didier Moreau	278
INTRODUCTION	Christian Muller and Didier Moreau	280
THE ATLAS MISSION OPERATIONS: THE SPACE REMOTE OPERATION CENTRE	Didier Moreau and Christian Muller	281
THE BELGIAN USER SUPPORT AND OPERATIONS CENTRE	Didier Moreau and Marie-Claude Limbourg	282
ODISSEA AND CERVANTES MISSIONS	Marie-Claude Limbourg and Didier Moreau	283
SOLAR AND THE ATMOSPHERIC SPACE INTERACTION MONITORING INSTRUMENT	Alice Michel and Nadia This	284
PICARD	Michel Anciaux and Claudio Queirolo	285
MULTI-PURPOSE END-TO-END ROBOTIC OPERATION NETWORK TELEROBOTICS	Karim Litefti and Rachid Abjj	287
PREPARING THE LONG TERM SPACE DATA PRESERVATION	Christian Muller and Didier Moreau	288
<hr/>		
17. CONCLUSIONS AND PERSPECTIVES	Martine De Mazière, Johan De Keyser, and Didier Fussen	290
<hr/>		
LIST BIRA-IASB PERSONNEL		298
ACRONYMS		300

ACKNOWLEDGMENTS

BIRA-IASB gratefully acknowledges the financial support received throughout its 50 years of history, allowing the institute to move forward and tackle new research challenges.

We want to express our special thanks to

- Federal Public Planning Service Science Policy, also known as Belgian Science Policy (BELSPO), formerly Federal Office for Scientific, Technical and Cultural Affairs (OSTC), Science Policy Office (SPO);
- Centre National de la Recherche Scientifique (CNRS);
- Centre National d'Etudes Spatiales (CNES);
- European Space Agency (ESA), including the European Space Astronomy Centre (ESAC), the European Space Operations Centre (ESOC), the ESA Centre for Earth Observation, also known as the European Space Research Institute (ESRIN), and European Space Research and Technology Centre (ESTEC);
- European Commission (EC);
- European Organisation for the Exploitation of Meteorological Satellites (EUMETSAT);
- Fonds National de la Recherche Scientifique (FNRS);
- Ministère de l'Education nationale and the Ministerie van Onderwijs;
- Nationaal Fonds voor Wetenschappelijk Onderzoek (FWO);
- Institut pour l'Encouragement de la Recherche scientifique dans l'Industrie et l'Agriculture (IRSIA) , now Fonds pour la formation à la Recherche dans l'Industrie et dans l'Agriculture (FRIA);
- Agentschap voor Innovatie door Wetenschap en Technologie (IWT);
- International Association for the Promotion of Cooperation with Scientists from the New Independent States of the Former Soviet Union (INTAS);
- LOTTO;
- PROgramme de Développement d'Expériences scientifiques (PRODEX);
- Société nationale industrielle aérospatiale (SNIAS);
- Chemical Manufacturing Association (CMA).

for their long-term funding support.

We also greatly appreciate the in-kind contribution and support by

- Canadian Space Agency and University of Waterloo;
- Centre des Etudes Terrestres et Planétaires, St Maur - Parijs (CETP);
- European Centre for Medium-Range Weather Forecasts (ECMWF);
- Finnish Meteorological Institute (FMI);
- Institut für Umweltphysik, Universität Bremen (IUP);

- Institute of Atmospheric Physics, Chinese Academy of Sciences, China (IAP, CAS);
- International Space Science Institute, Bern (ISSI);
- Katholieke Universiteit Leuven (KULeuven);
- Koninklijk Meteorologisch Instituut - Institut Royal Météorologique (KMI-IRM);
- Koninklijk Nederlands Meteorologisch Instituut (KNMI);
- Koninklijke Sterrenwacht van België - Observatoire Royal de Belgique (KSB-ORB);
- Laboratoire de l'Atmosphère et des Cyclones (LACy), Université de La Réunion/CNRS/Météo-France ;
- Laboratoire d'Optique Atmosphérique, Université Lille 1, Villeneuve d'Ascq (LOA);
- Laboratoire de Physique et Chimie de l'Environnement et de l'Espace, Orléans, France (LPC2E);
- Laboratory for Atmospheric and Space Physics, University of Colorado Boulder (LASP, CU-Boulder);
- LATMOS (see Service d'Aéronomie)
- National Aeronautics and Space Administration (NASA);
- National Center for Atmospheric Research (NCAR);
- Open University (OU);
- Physikalisches Institut Universität Bern, Switzerland (PUIB);
- Russian Space Research Institute (IKI);
- Service d'Aéronomie, (France), now Laboratoire atmosphères, milieux et observations spatiales (LATMOS);
- SouthWest Research Institute, Boulder, US (SWRI);
- Université Catholique de Louvain (UCL);
- Université de Bruxelles Libre (ULB);
- Université de Liège (ULg), including Gembloux Agro-Bio Tech;
- Universiteit Gent (UGent);
- Université de Namur, formerly FUNDP;
- Université Pierre et Marie Curie (Paris 6), Jussieu;
- Universiteit Antwerpen (UA);
- Vlaamse Instelling voor Technologisch Onderzoek (VITO);
- Vrije Universiteit Brussels (VUB);
- World Meteorological Organization - Science Advisory Group - UV Solar Radiation (WMO SAG UV);
- Max Planck Institutes (MPI)

We apologize to those we might have forgotten.



BEIGSCH INSTITUUT VOOR RUIMTE-AERONOME (BIRA) INSTITUTE D'AERONOME SPATALE DE BELGQUE (IASB) BELGIAN INSTITUTE FOR SPACE AERONOMY (BIRA-IASB) BELGICH INSTITUUT VOOR RUIMTE-AERONOME (BIRA) INSTITUT D'AERONOME SPATALE DE BELGQUE (IASB)

PREFACE

Dirk Frimout



Space Shuttle launch (credit: NASA)

At the time when the Belgian Institute for Space Aeronomy was created, aeronomy was a science relatively unknown to the general public. The term aeronomy was first introduced in 1946 by Professor Sydney Chapman, assigned in 1953 as President of the Special Committee for the International Geophysical Year (IGY) in 1957-58, who defined it as *the science of the upper region of the atmosphere, where dissociation and ionization are important*. Most fittingly, it is during the IGY that the space age begins with the launch of the first artificial satellite, Sputnik, by the USSR.

Located next to the Royal Observatory and the Royal Meteorological Institute in Uccle the Belgian Institute for Space Aeronomy was created in 1964 under the initiative of Professor Baron Marcel Nicolet with the full support of King Baudouin. Professor Nicolet was an internationally well-known scientist of the Meteorological Institute, who in 1953 was assigned as Secretary-General of the IGY and whose achievements in scientific research and administration earned him honors such as the Guggenheim prize.

Professor Nicolet became the first director of the Belgian Institute for Space Aeronomy. The Institute commenced its activities on the 1st of January 1965, provisionally in a building of the Meteorological Institute, but later on it moved into its own buildings. Following the IGY, Professor Nicolet had been able to gather around him a young, ambitious team of collaborators and the closest formed the first core of the scientific personnel. Building on his international experience, he insisted that the Institute be multidisciplinary, meaning, composed of a strong theoretical division, that worked closely together with an experimental group, with the support of a technical division. This approach enabled the Institute to make use of the new space age technologies to perform in situ measurements in the high atmosphere.

As a young engineer, I started my career in this newly created institute. Also to me, aeronomy was an unknown science. All I knew was that it studied the higher atmosphere and that space experiments would be required to fulfill this task. That aspect of the job was very attractive to me. The young Institute started with plenty of ambition, but with a limited budget. Under the leadership of Dr. Baron Marcel Ackerman, we built instruments to perform space experiments, but with our lack of experience and money, we could not make use of sounding rockets or satellites, that had become the international standard at that time. Fortunately, because of the international relations of Prof. Nicolet and Dr. Ackerman and their contacts with the CNES in France, we could perform experiments with stratospheric balloons. These balloons, with a volume of up to 300 000 m³, could carry a payload weighing up to 300 kg to an altitude of 40 km where it could perform measurements in the stratosphere during several hours. Stratospheric balloons were called the “satellites of the poor” but they fitted very well our research which focused on the stratosphere. Our experimental research concerned a priori the study of the ozone layer and the ultraviolet light of the Sun, both not measurable with Earth-based experiments.

In 1970, the scientific emphasis moved worldwide to the problem of global pollution in the stratosphere, especially the chlorofluorocarbons and nitric oxides. This was partly triggered by an economic interest as big airplane producers like Aérospatiale in France and Boeing in USA, planned the construction of supersonic airplanes, intended to fly in the stratosphere. People were afraid that soon a large flotilla of supersonic airplanes, such as the Concorde, would fly daily over the ocean between Europe and America and that the exhaust of nitric oxides would attack the ozone layer. This would have a major impact on our atmosphere. With the experience of stratospheric balloons, the Belgian Institute for Space Aeronomy was in a good position to perform the required measurements and so, the Institute added the measurement of vertical profiles of a number of important minor constituents by absorption measurements in the near infrared part of the spectrum to its experimental program. A close collaboration was started with ONERA in France, who had developed an instrument, specially adapted for this purpose: the Grille Spectrometer. With this instrument, vertical profiles of several minor constituents could be measured at different latitudes. This allowed us to acquire quite some data, important for verification of the mathematical models developed by the theoreticians in the Institute. All these results contributed to the study of the greenhouse effect and the global warming of the Earth. The arrival of the Space Shuttle allowed for the first time to perform global measurements, and hence, the Grille Spectrometer was proposed to fly on the joint NASA-ESA mission Spacelab I.



Dirk Frimout presenting the mockup of the Space Shuttle and Spacelab in the cargo bay.



Dirk Frimout during the Atlas 1 mission.

In collaboration with CNRS in France, the Belgian Institute for Space Aeronomy had also developed two other instruments, SOLSPEC and ALAE, both of which performed measurements of the Sun, and that were selected for the Spacelab 1 mission as well. In this way, the Institute was involved in three experiments on the Spacelab 1 flight in November 1983. They all were successful and brought a quantity of good data for the modelling of the stratosphere. All three experiments flew a second time on the ATLAS 1 mission in 1992. I was proud to have these experiments on board and to be able to control their good functioning during the flight.

Since then, the Belgian Institute for Space Aeronomy has evolved and has become more and more international. Many new groups were created within the Institute and have contributed to its international recognition. The activities and the research results related to the magnetosphere and plasma physics, to mass spectrometry, to planetary atmospheres and to so many other subjects, are all discussed in this publication.

The success behind this young institute is due to many factors, first of all the well-chosen multidisciplinary composition of the team of scientists, technicians and support teams, all delivering high-quality work. From the beginning, there was contact and collaboration with leading institutes from all over the world. The Institute got involved in and contributed to many international projects. It was a homogeneous team of young scientists with an experienced leadership and most of all with the necessary commitment and sense of adventure. This policy continued with the new generation of young scientists that took the torch from the first generation. The research has extended towards the atmospheres of the planets Mars and Venus. There are continuously new challenges, which will always attract young scientists.

I personally have many reasons to thank the Belgian Institute for Space Aeronomy. Specifically, I had the opportunity to expand my talents, which included preparing a doctoral thesis and spending a postdoctoral year at the University of Colorado in the United States. For many years, I was lucky to work in a highly qualified team of scientists, with dedicated technicians and with good administrative support. Together we got to know the sweetness of success during the launch campaigns, but also the deceptions of failures.

The Belgian Institute for Space Aeronomy was also my springboard to space. Thanks to their support, I got the unique opportunity to become a candidate to participate in the ATLAS 1 mission, and this support never ceased. Even when I left the Institute, I still felt closely linked to it. I continued to follow their successes. I still admire their creativity, their dedication and their scientific performances. I know that I can always count on their expertise when I need information. On the occasion of this 50th anniversary, I want to thank them all for the help they have given. Congratulations to the young, dynamic team that is taking care of the continuity and future of the Institute.



Dirk Frimout working in the upper deck of the Shuttle during the ATLAS 1 mission.

2



BELGISCH INSTITUUT VOOR RUIMTE-AERONOMIE (BIRA) INSTITUT D'AERONOMIE SPATIALE DE BELGIQUE (IASB) BELGIAN INSTITUTE FOR SPACE AERONOMY (BIRA-IASB) BELGIECH INSTITUUT VOOR RUIMTE-AERONOMIE (BIRA) INSTITUT D'AERONOMIE SPATIALE DE BELGIQUE (IASB)

“If we long for our planet to be important, there is something we can do about it. We make our world significant by the courage of our questions and the depth of our answers”
(Carl Sagan)

SPACE AERONOMY: A HISTORICAL INTRODUCTION

Paul C. Simon



Meeting of the Special Committee of the IGY in Brussels. From left to right: Vladimir Belousov, Lloyd Berkner, Marcel Nicolet, Jean Coulomb and Sydney Chapman. (courtesy Life magazine)

In the evening of October 4th 1957, the Soviet embassy in Washington was hosting a reception for the members of the International Geophysical Year (IGY) Committee, when Lloyd Berkner, Vice-President of the IGY, was informed of very surprising news. He immediately informed the other guests that a Soviet satellite was orbiting around the Earth at an altitude of 900 km and he congratulated its Soviet colleagues “for this remarkable success”.

Lloyd Berkner’s surprise was shared worldwide. The news of Sputnik-I being launched caused considerable emotions: enthusiasm in the eastern countries, astonishment in the western countries and admiration in the third countries.

The Soviet Union had suddenly seen its prestige increased, its military power re-evaluated and it was ready to take political benefit from this spectacular success. The USA were worried about the military implications and their obvious loss of technical and scientific supremacy. The cold war was taking a new dimension: space.

The space era was taking off with his three major pillars: scientific, political and strategic. Its scientific dimension was defined by the IGY. This worldwide scientific programme had started in 1953, with Baron Marcel Nicolet, founder of the Belgisch Instituut voor Ruimte-Aeronomie/Institut d’Aeronomie Spatiale de Belgique (abbreviated as BIRA-IASB), as Secretary-General. This initiative concretised the necessary synoptic vision for the study of the Earth atmosphere.

The use of scientific satellites had been brought up during the first meeting of the special IGY committee and had been officially recommended in 1954. The scientific challenge was raised by the USA in 1955 and the year after, by the U.S.S.R.



Adolphe Quetelet
(1796 - 1874)
Founder of the Royal
Observatory
of Belgium.

The IGY was preceded by three international scientific initiatives.

In 1850, Mathew Fontaine Maury, Director of the Naval Research Laboratory, proposed an international agreement on the coordination of meteorological observations at the sea surface. Within this framework, a maritime conference was organized in Brussels in 1853 under the chairmanship of Adolphe Quetelet, Director of the Royal Observatory of Belgium, precisely a hundred years before the first meeting of the special IGY committee. Instrument calibration and validation problems such as the barometer and the thermometer were already addressed.

The first International Polar Year (IPY) (1882-83) initiated by Karl Weyprecht, from the Austrian Navy, led to important instrumental developments.

The second IPY (1932-33), marking its 50th anniversary, took place under a difficult economic context. During this period, space technology as well as the study of the chemical and physical processes of the atmosphere was only in its infancy

HISTORICAL SUMMARY

It took 2000 years for Archimedes' theory, transposed to gas, to be applied to balloons.

On June 4th, 1783, the first flight of a hot air balloon was realized by the Montgolfier brothers. It lasted 20 minutes and flew at an altitude of 20 m. On 21 November 1783, Pilâtre de Rozier and the Marquis d'Arlandes made their first manned flight during 20 minutes. On the 1st of December 1783, Charles and Robert, who had previously experienced the use of hydrogen, made a flight of 2 hours, covering a distance of 40 km. Only the first manned space flights, including the flights of two Belgian astronauts, Viscounts Dirk Frimout and Frank De Winne, brought such equivalent enthusiasm as these discoveries of the late 18th century.

Twenty years later, on July 18th, 1803, Robertson and Lhoest made a first scientific ascent that included magnetic measurements. They reached an altitude of 7000 m. This flight was followed in 1804 by a flight reaching 4000 m (Gay-Lussac and Biot), but it took another fifty years for new strictly scientific ascents to take place. In 1862, Glaisher and Coxwell flew at an altitude of 11,000 m. However, the aerostats were not very efficient for atmospheric studies. The synoptic vision of physical parameters was established through climatological observation networks. The sounding balloons were only used in meteorology from 1892 and the first stratospheric soundings by means of balloons were realised in 1896.

During that period, the aeronomic study of planetary atmospheres was exclusively based on data resulting from ground-based observations, as well as on experimental interpretations from scientific research in the domain of spectroscopy or radio-electricity.

In the past, one could only deal with indirect methods, such as deductions from an interpretation of the variations of the terrestrial magnetism, or simply observations (with the naked eye at first, photographic later on) of luminous phenomena appearing at high altitude (over 80 km) at twilight, such as noctilucent clouds, shooting stars or the aurora borealis. At that time, the meteor trails in the sky could not yet be interpreted in the context of their destruction in the upper atmosphere. The aurora borealis had been the subject of a dissertation by Jean-Jacques Dortous de Mairan in 1731, evoking possible relations with the terrestrial magnetism.

Following the discovery of the electron, Birkeland suggested in 1896 the idea that polar auroras resulted from electrons emitted by the Sun colliding with terrestrial molecules. In this way, the atmospheric effect of the terrestrial magnetic field, influencing the trajectory of electrified particles such as the electrons by driving them to the Polar regions, was introduced.

In the end, spectroscopic observations of the radiation associated the to aurora borealis were made, but the spectral identifications were in a too early stage to actually bring new knowledge on the constitution of the upper atmosphere. The famous green line of oxygen emitted by the auroras and the nocturnal sky was attributed to an unknown element: the geocoronium.

Later on, studying the frequency of the appearance of the auroras allowed an approach for the study of secular cycles of the solar activity and corresponding climatic periods during this millennium.

The kinetic theory of gas was now sufficiently developed (Boltzmann, Maxwell) to allow a theoretical approach of the atmosphere, but the chemical composition and the physical characteristics of the Earth's atmosphere as well as of other planets of the solar system could only be revealed gradually.

The end of the Phlogiston theory during the 18th century (Lavoisier, Schraele, Priestley and Cavendish) led to the recognition of the existence of two main atmospheric gases: oxygen and nitrogen. The nitric oxides, today a well-known pollutant, were produced by Cavendish in a discharge of dry air where oxygen was added. Nevertheless, it was only more than a century later that a real step forward was made, with the discovery of helium (Kayser) and argon (Ramsay) in the terrestrial atmosphere in 1895 and the detection of other noble gases (krypton, neon and xenon) thanks to liquid air, in 1898.

The first real spectroscopic detection of ozone was realized by Chappuis in 1880. One year later, Hartley discovered in his laboratory a strong absorption band in the ultraviolet indicating that this constituent was shielding the Earth from the abiotic solar ultraviolet radiation under 300 nm. In 1890, Huggins discovered a series of telluric absorption rays in the near ultraviolet which would later on be attributed to ozone by Fowler and Strutt in 1917.

Geophysics and more specifically the study of planetary atmospheres really advanced in the early 20th century. Major contributions on the properties of the upper atmosphere saw daylight. Indeed, in 1901, Marconi established the first transatlantic radio link between Poldhu in Cornwall and Newfoundland in St Jean de Terre-Neuve. Soon afterwards, this was explained by the existence of an electrical conduction layer in the upper atmosphere (1902, Kennely, Heaviside). This reflecting layer of the radio-electric wave must be constituted from charged particles (ions and electrons) produced by the Sun ultraviolet radiation, not yet observed, ionizing the upper atmosphere constituents. This result spotlighted the hypothesis introduced in 1888 by Steward and again recognized by Schuster in 1889, suggesting that part of the terrestrial magnetic field was associated to electric currents resulting from the existence of ions and electrons in the upper atmosphere.



First flight of the Montgolfière to Annonay (France) on the 4th of June 1783.

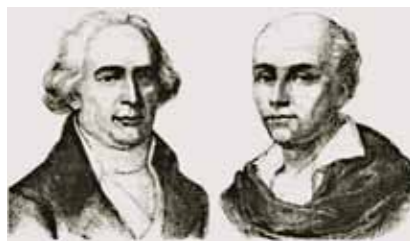

The brothers Joseph and Etienne Montgolfier.



Olaf Christian Bernhard Birkeland (1867 - 1917),
Physics professor at the University of Oslo.



Guglielmo Marconi (1874 - 1937)
Nobel Prize in Physics in 1909.



Gordon Miller Bourne Dobson (1889 - 1976), Physicist and meteorologist at the University of Oxford, member of the Royal Society. (courtesy Oxford)

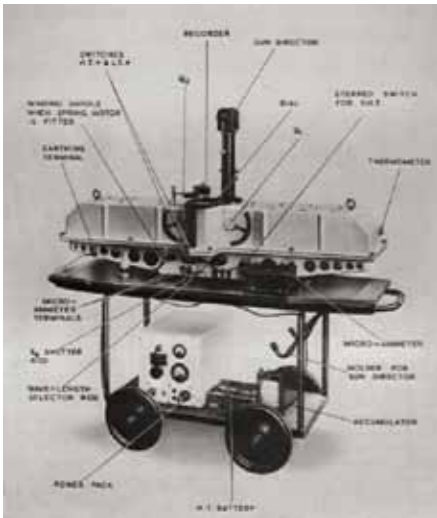

The first instrument which is capable of measuring ozone from the ground : the Dobson spectrophotometer (1924). (courtesy Oxford)

The First World War did not allow any progress in the development of knowledge of the upper atmosphere, unless through the unexpected result of the abnormal propagation of the cannon noise. Indeed, zones of silence were discovered, beyond which the noise reappeared, at unexpected distances. A few years later, it was attributed to the echo of a sounding wave reflected by the stratosphere where the temperature is higher than in the tropopause. More recently, the explosion of grenades at high altitude was used to determine the temperature at altitudes up to 85 km.

After World War I, several significant findings helped to recognize aeronomy as a basic science for atmospheric environment.

Spectroscopic studies moved towards the identification and characteristic emissions of the main constituents of the atmosphere, nitrogen and oxygen. It was thus recognized that oxygen appears in the form of atoms above 100 km, while nitrogen maintains itself in a molecular form at higher altitude. Nevertheless, when it became clear that the atmosphere constituents are in mixing above 20 km, the problem of the diffusion of gas in the gravity field led to the consideration that the distribution of each gas following the Dalton Law, i.e. following its own mass, had to occur at a certain altitude.

Meanwhile, radio amateurs had discovered the propagation of short waves at long distance (1921-1925). In 1924, Larmor, with his theory of the electron refraction, provided a new field of scientific investigation to the study of the ionosphere as well as to new concepts for the aeronomy. Moreover, the radio-electric propagation by the study of echoes of short waves (1926, Breit and Tuve) and by the analysis in the framework of magneto-ionic theory (1932, Appleton) could be adapted to a sounding of the ionosphere, i.e. the entire region above 60 km, where imagination had placed electrons produced by ionization of atoms and of molecules under the effect of both the ultraviolet radiation and the X solar rays.

Finally, thanks to the development of constantly improving spectrographs, the night glow of the nocturnal sky was analysed through its molecular and atomic emissions.

The progress in aeronomy thus allowed defining how chemical reactions could lead to luminous emissions, at the moment World War 2 started.

The first measurements of stratospheric ozone started in 1920 with a study on absorption of the solar ultraviolet radiation in the bands of Hartley and Huggins, leading to the first determination of the total ozone content in the atmosphere. Gordon Dobson designed an instrument based on absorption spectroscopy of in the near ultraviolet which was installed for the first time in Arosa (Switzerland) in 1927 before being deployed

in a network within the framework of the IGY in 1957-1958. The photochemical theory on the ozone layer was introduced in 1929 by Sydney Chapman.

In parallel, scientific and technical bases of the space conquest started in the early 20th century. In 1903, Konstantin Tsiolkovski initiated the mathematical basis for rocket flight. On March 16th, 1926 (143 years after the first balloon flight), the first rocket, built by Robert Goddard, flew at an altitude of 56m. The USSR invested in the same field, Sergei Korolev soon overtook the American technical realizations, tracing the prolegomena of the future race to the Moon.

The aerostat was, however, not totally abandoned; the Swiss Auguste Piccard and Paul Kipfer on board the FNRS gondola penetrated the stratosphere (15781m) for the first time on the 27th of May 1931 with a pressurized gondola, with a diameter of 2m10, attached to a 30 m diameter balloon (14130m³). The scientific goals of this flight were the measurement of the cosmic radiation, of the ionization of the air and of the electrostatic field. This first exploration of the stratosphere was followed by the flight of Max Cosyns and Nérée Van der Elst in 1934. The exploration of the stratosphere by manned balloon flights has been a brilliant Belgian scientific adventure.

During World War 2, the intensive use of radio-communications led to the systematic study of the ionosphere, undergoing the ultraviolet radiation of the Sun and the variations due to the 11-year solar activity cycle. Radar was at the basis of the discovery of solar emissions in the ultra-short wavelength domain, and hence, of research on the relations between solar and terrestrial phenomena which would lead to new scientific developments.

During this war, also the first ballistic missiles (V-2 rocket) were produced by a German team led by Werner Von Braun in Peenemünde in order to satisfy the ambitions of Adolf Hitler. The V-2 rocket meant a decisive technical progress: gyroscope, turbo-pump... in order to make the engines work. It was a failure from a military point of view because its explosive charge made too few damage compared to the huge cost of its construction for the Nazi regime.

Thanks to the V-2 rocket, Von Braun and his team of about hundred persons, as well as the collection of German working documents falling in the hands of the Americans, initiated the U.S. space programme.

In 1946, the Naval Research Laboratory carried out the first scientific space experiments with V-2 rockets. These experiments dealt with the first measurements of the ultraviolet radiation absorbed by the ozone in the stratosphere and the first measurements of the vertical distribution of the ozone concentration.



Launch of a V-2 rocket. (credit: NASA)

The first phase of the space era was hence the product of a military policy; the rocket was the “daughter” of the war. The space launcher was only a ballistic missile, with the need of a supplementary stage for orbiting satellites.

Around 1950, the aeronomy became, thanks to a few geophysicists, an official science, following the creation of the International Geomagnetism and Aeronomy Association within the framework of the International Union of Geodesy and Geophysics (cf. General Assemblies of Oslo 1948, Brussels 1951 and Rome 1954).

With the beginning of the space era, there was an extraordinary development of the study of all physical and chemical proprieties of atmospheres, hence aeronomy, i.e. the study of phenomena in which dissociation and ionization of molecules and atoms play crucial roles.

In this way, the role of the solar ultraviolet radiation on atmospheric atoms and molecules became the subject of scientific studies to identify the nature of elementary processes determining the composition and the constitution of the atmosphere, from the stratosphere to the exosphere (neutral atmosphere) and of the ionosphere (charged particles) to the very edge of interplanetary space (solar wind).

At that time, The Soviets and the Americans would develop ballistic missiles in the context of the Cold War. The first US ballistic missile with a range of more than 300 km was launched in August 1953. Since 1949, the Soviets had reached a 900 km range!

It is in such a political and scientific context that the commission on ionosphere met in Brussels in September 1950. The commission decided the constitution of a special committee of the IGY with a first plenary meeting in July 1953. During this plenary meeting, the use of satellites for scientific purpose was proposed.

Sydney Chapman was elected president and Marcel Nicolet (Royal Meteorological Institute, RMI) became secretary general.

The bureau was composed of one Soviet, one American, one French, one British and one Belgian scientist. Fourteen rapporteurs were designated from different disciplines of geophysics, including Marcel Nicolet and Jacques Van Mieghem.

The special committee of the IGY officially recommended the launch of small scientific satellites during its 2nd meeting in Rome, in 1954. The year after, the US national committee gave a positive answer with a first objective: the study of particles and radiation outside the atmosphere.

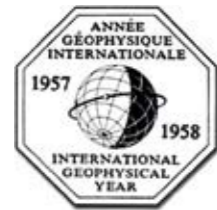

Paul Kipfer and Auguste Piccard in front of the pressurized F.N.R.S.-gondola of the stratospheric balloon that flew on 27 May 1931. (credit IBA-ARCHIV)



Commemorative stamp for the stratospheric balloon flights of Picard in 1931 and 1932.

In 1956 in Barcelona, the U.S.S.R. presented its programme during the 4th special committee of the IGY.

In 1957 and 1958, the IGY allowed worldwide geophysicists to gather their efforts in order to study our planet at all latitudes and longitudes up to the highest altitudes. Together with the first satellites, the deployment of the instrument designed by Gordon Dobson in a worldwide network for the observation of the total amount of ozone in the atmosphere and the launch of 10000 sounding meteorological rockets were achieved.

The Dobson instrument located at Halley Bay in Antarctica led to the discovery of the ozone hole in 1985, formed since the late seventies at each austral spring above this continent.

Since the end of the IGY, which saw the development of these fundamental researches on a planetary scale, the conquests of aeronomy were immense thanks to space missions oriented towards the atmosphere of the Earth and other planets, as well as towards interplanetary space.

TOWARDS RECOGNITION OF SPACE AERONOMY IN BELGIUM

In the 1930s, Jules Jaumotte, director of the Royal Meteorological Institute (RMI) introduced the Norwegian method of synoptic meteorology and designed miniature meteorographs penetrating inside the stratosphere where they detected the variations in temperature gradient increasing with altitude.

In 1937, Marcel Nicolet presented his thesis called "Discussions on Thermic Inversion Observed in the Stratosphere". A little later, he devoted himself to aeronomy, studying the photochemical processes initiated by the solar radiation at the ground level and determining the aeronomic processes that - today - play an essential role in the interactions with the biosphere and the geosphere, which have to be taken into account in global changes studies due to human activities.

In May 1939, Marcel Nicolet published "Atomic Problem in the Upper Atmosphere", where he suggested the existence of oxygen, nitrogen, helium, hydrogen atoms at inaccessible heights with experimental techniques available at that time.

In expectation of the development in Belgium of aeronomic research based on a space conception, the RMI Director, Jules Jaumotte, had already conceived a project for a section within his institute dedicated to radiation, with a very large vision of radiation studies in our country.

Dramatic events affected the RMI in the beginning of World War 2, when J. Jaumotte passed away due to injuries incurred while he was embarking for England. In view of protecting the Belgian staff in charge of weather forecasting, several members of the Royal Meteorological Institute, among them Marcel Nicolet, created different departments: climatology, aerology, terrestrial magnetism and electricity, and radiation, in which all the RMI staff was then integrated.

This creation of different departments due to very exceptional circumstances gave the opportunity to develop, on a long-term basis, fundamental research in various directions and to contribute to scientific developments which still explain the importance of Belgium in space studies related to the atmospheric environment.

The first conception of an "aeronomy" section in our country, at the RMI, dates back to September 1939, thanks to its Director Jules Jaumotte. Twenty years later, after the first artificial satellites, a specific place for space aeronomy was defined within the international frame.



Jules Jaumotte (1919 - 1940)
Director of the Royal Meteorological Institute of Belgium.



Baron Marcel Nicolet (1912 - 1996)
Founder of the Belgian Institute for Space Aeronomy.

The development of space aeronomy in Belgium appeared in 1953 during the preparation of the IGY (1957-58), with the encouragement of the Secretary-General of the committee, Marcel Nicolet, installed at the Royal Meteorological Institute radiation department.

On the 30th July 1959, the National Centre for Space Research (NCSR) was created. Its founders belonged to all national universities and scientific institutions. The creation of COSPAR (International Committee of Space Research) was the initiator for the NCSR. The founders proposed to the Academies the creation of the NCSR to improve the relationship with COSPAR.

In its charter, it is indicated that the NCSR's purpose is to promote studies related to space research, to develop the training of specialized scientists, to exercise research works in view of exploiting findings made on the international level and to centralize as well as store data and documentation relevant to space research. During the same period, under the auspice of the Ministry of Foreign Affairs, meetings of representatives of different ministries (Economy, Finance, Education, Scientific Policy etc.) prepared the political community to a European participation for the Intergovernmental Conference of Geneva (28th November 1960). The aim of this conference was to create a preparatory commission to study a possible collaboration between European partners in the field of space research (meetings in Paris, Den Haag and Munich).

Meanwhile, in July 1960, the National Council for Scientific Policy recommended our country to accept the principle of the creation of the intergovernmental preparatory commission. The conventions for the creation of two European organizations were signed in 1962 "ad referendum" and submitted to the parliaments: ELDO (European Launcher Development Organization) and ESRO (European Space Research Organization).

On the 28th of May 1962, the National Council for Scientific Policy transmitted to our government its recommendations concerning the promotion of space research. In short, a national institute was described by a structure in four departments (mathematical, theoretical, experimental and applied aeronomy) and 8 sections related to respectively numerical analysis, fundamental dynamics, atmospheric and interplanetary physics and chemistry, physical chemistry of the ionosphere, photochemistry, optics, instrumentation and radio-electricity. The Official Journal (Moniteur belge/Belgisch Staatsblad) of November 25, 1964, published a Royal Bylaw, announcing that "the Aeronomy section was to be detached from the Royal Meteorological Institute under the name "Belgisch Instituut voor Ruimte-Aeronomie/Institut d'Aeronomie Spatiale de Belgique".

The Royal Decree underlines that the institute has as essential attributions the public service and research tasks in the domain of space aeronomy, and that these missions require the knowledge of data acquired with the help of rockets and artificial satellites in the framework of the physics and chemistry of the upper atmosphere and of the extra-atmospheric space.

For this goal, the institute is therefore in charge of:

- Acquiring and archiving information obtained via rockets and artificial satellites;
- Providing this information to the people and organisations interested in space problems, and therefore build up documentation in this field;
- Proceeding with the investigation of applied experimental methods as well as with the analysis of the acquired observations and their interpretation;
- Carrying out the research needed for the improvement and application of calculation methods;
- Accomplishing all above-mentioned efforts in view of their implementation in the national or international framework;
- Designing and setting, for this purposes, the necessary instrumentations;

Since then, BIRA-IASB has carried out space observations with stratospheric balloons, carrying scientific loads of several hundreds of kilos at an altitude of 40 km, on board the Space Shuttle, during Dirk Frimout's flight in 1992, and also with many past, present and future satellites dedicated to atmospheric environment.

In parallel, the modelling of the atmosphere and of the magnetosphere was largely developed, with the analysis of observational data and the study of long-term trends like the one of ozone and climatic changes.

CONCLUSION

Progress in science cannot be explained without historical background. The twentieth century and the conquest of space can be characterized by the synergy between science and technics, between knowledge and know-how. This approach is particularly valid for the Earth and Space sciences, which have concretised this interdependence during the last century.

Moreover, there has been convergence between military objectives and the technological needs for the conquest of space. But it is the scientific community that triggered off this endeavour. The IGY played a major role. The discovery of the Van Allen radiation belts by Explorer 1 and 3 satellites is a perfect example. At present, it is still subject of research at BIRA-IASB in the framework of the European Space Agency (ESA). In the mid-1960s, both economic and strategic objectives became dominant, leading to the notion of intellectual products. Scientific data and their analysis have become a matter of business...

Space has been taken over for political and strategic goals even though science was its first justification, the balloon and the aircraft had undergone the same fate.

Space conquest was and remains a prestigious enterprise doubled with economic stakes.

Today, space programmes must position themselves according to the 21st century challenges: global changes of the Earth, anthropogenic impacts, risk evaluation associated to our environment changes, etc.

The elements for correct answers can only be found through international and trans-disciplinary scientific approaches.

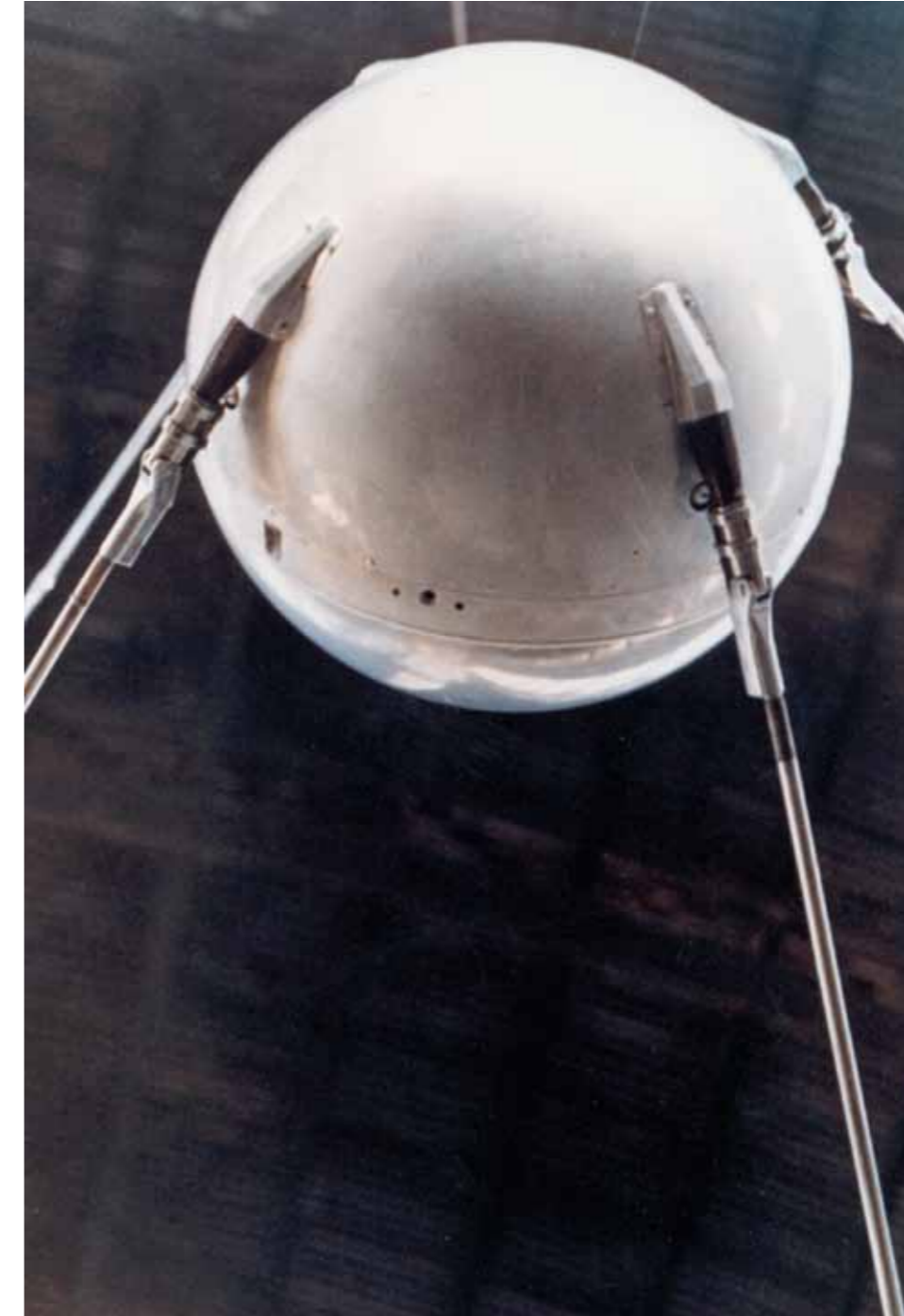

The first artificial satellite, Sputnik 1, launched on 4 October 1957

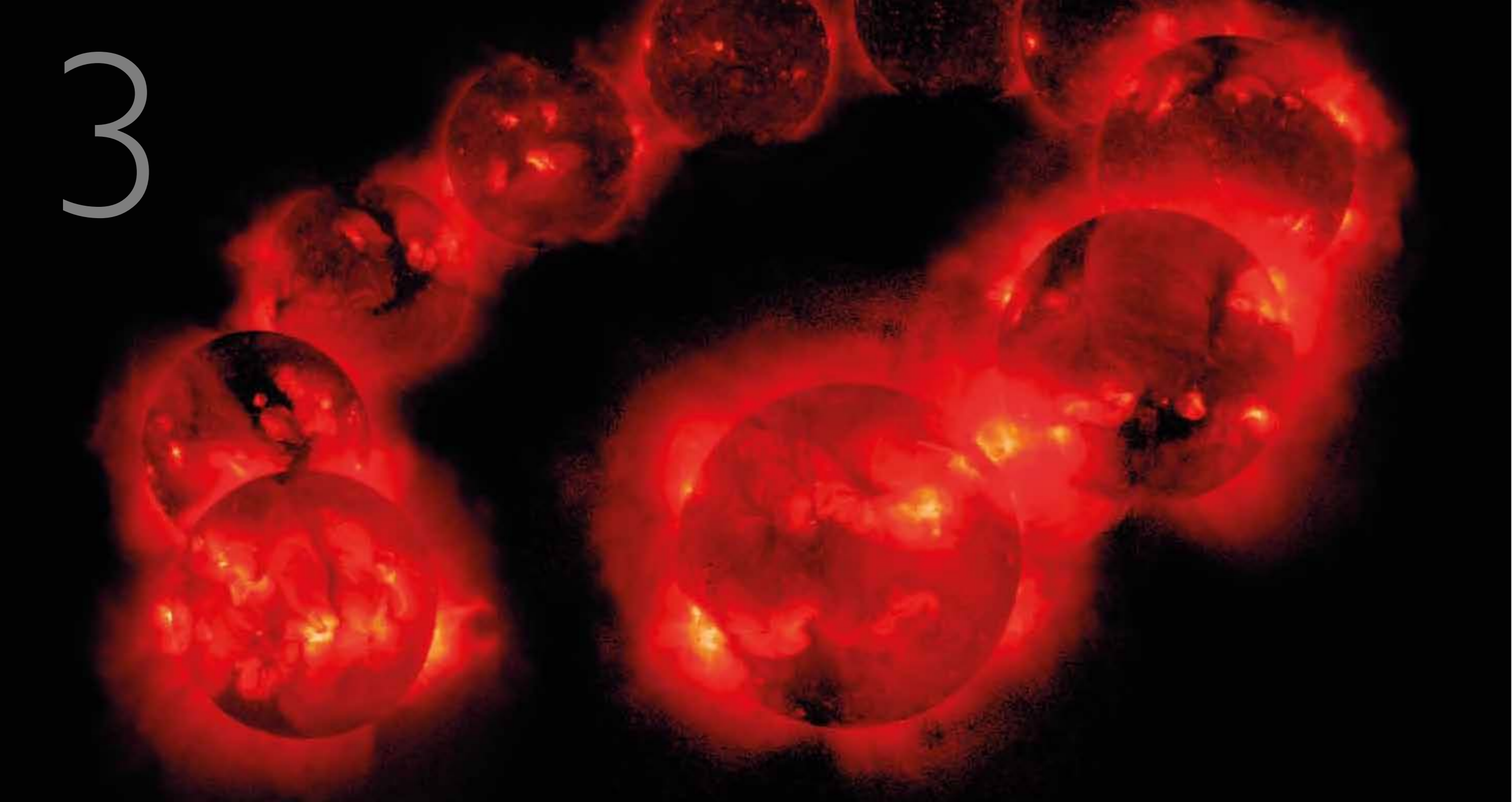

BELEGCH INSTITUUT VOOR RUIMTE-AERONOMIE (BIRA) / INSTITUT D'AERONOMIE SPATIALE DE BELGIQUE (IASB) / BELGIAN INSTITUTE FOR SPACE AERONOMY (BIRA-IASB) / BELGICH INSTITUUT VOOR RUIMTE-AERONOMIE (BIRA) / INSTITUT D'AERONOMIE SPATIALE DE BELGIQUE (IASB)

THE SUN AND THE EARTH'S ENVIRONMENT

Paul C. Simon

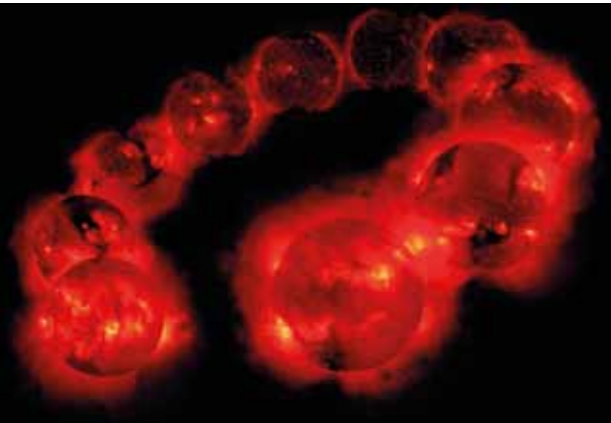

Paul C. Simon, Viviane Pierrard, and Joseph Lemaire

The 11-year solar activity cycle as seen in the X-Ray wavelength range from August 30, 1991 to September 6, 2001.
(Credit: the Yohkoh mission of ISAS (Japan) and NASA)

The Sun is a typical star, emitting electromagnetic radiation and charged particles (the so-called “solar wind”) which both impact the Earth’s atmosphere. The solar electromagnetic radiation is the primary source of energy for the Earth’s system. The Sun emits the whole spectrum of electromagnetic waves: visible light, of course, but also infrared (IR) and ultraviolet (UV) radiation as well as radio waves, x-rays, and gamma rays. The largest fraction of its energy is, however, situated in the visible wavelength range. The ultraviolet domain for wavelengths shorter than 320 nm represents only a small fraction (2%) of the total incident flux. This spectral range is of fundamental importance for aeronomic processes taking place in the troposphere, the middle atmosphere and the thermosphere.

The major contributions to the energy balance of the atmosphere come from heating through the absorption of solar ultraviolet (short-wave) radiation and from cooling to space through infrared (long-wave) radiation. Local imbalances between short-wave heating and long-wave cooling provide the driving forces for dynamical processes. Much effort has been invested in the past decade to accurately measure the solar irradiance in various wavelength bands and its variability on both short and long timescales.

Because of the complexity of the atmospheric processes and the strong interplay and feedback between transport, chemical composition and radiative budget, atmospheric and climate studies should include observations of the ultraviolet solar radiation and its variability, in close relation with the atmospheric constituents which control the penetration of solar radiation.

Consequently, the knowledge of solar ultraviolet irradiance values as well as their temporal variations is fundamental in studying the chemical, dynamical and radiative processes in the middle atmosphere. In addition, the study of solar variability is of crucial importance to distinguish between its impacts on the terrestrial environment in comparison with anthropogenic perturbations.

The interaction between the Earth’s environment and the solar wind will be described in detail later on in this chapter.

THE SUN

Paul C. Simon

The Sun is one amongst billions of stars in our galaxy, the Milky Way, which is only one amongst millions of galaxies.

The Sun is a variable star with a “surface” temperature in the range of 5000 to 6000 Kelvin (K). Even though the Sun has no real surface, the outermost layer visible to the naked eye, the photosphere, is considered to be the Sun’s “surface”. The solar radius (R_s), determined by the edge of the photosphere, is almost 700000 km, which is about 110 times the radius of Earth, while its mass is about 333000 times larger than Earth (2×10^{30} kg).

The Sun is divided into four domains: the interior with a temperature of about 15 million K, the photosphere with a temperature of almost 6000 K, the inner corona, and the outer corona. The corona, the extended outer atmosphere of the Sun, has a very high and variable temperature of, on average, around 2 million K. Figure 2 describes the structure of the Sun from the core to the corona.

Located at a distance of, on average, approximately 1.5×10^8 km (defined as one astronomical unit, A.U.) from the Sun, the Earth is located in the so-called heliosphere, a region dominated by the solar wind. While the total irradiation emitted by the Sun, the so-called solar “constant”, is 1368 Watt/m^2 , the flux intercepted by the Earth averaged over one day is one fourth of this, i.e. 342 W/m^2 .

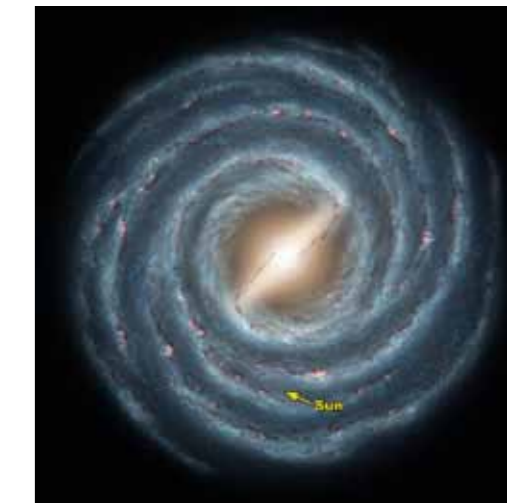

Position of the Sun in the Milky Way.
(credit: Caltech)

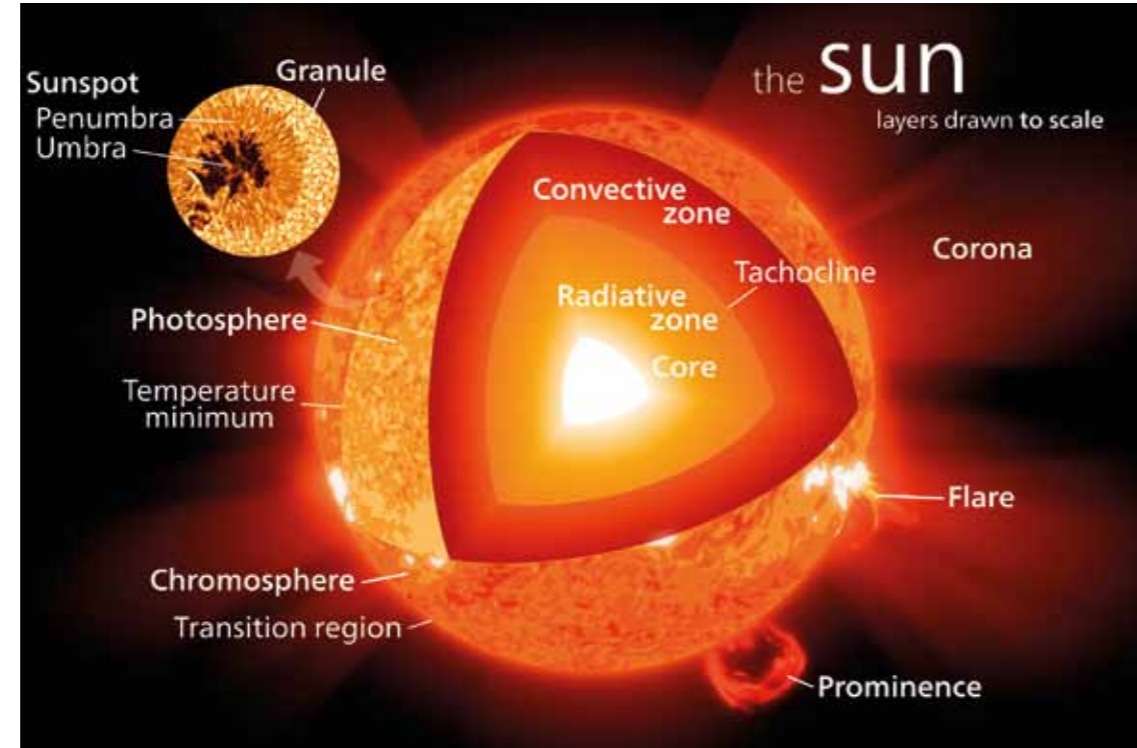
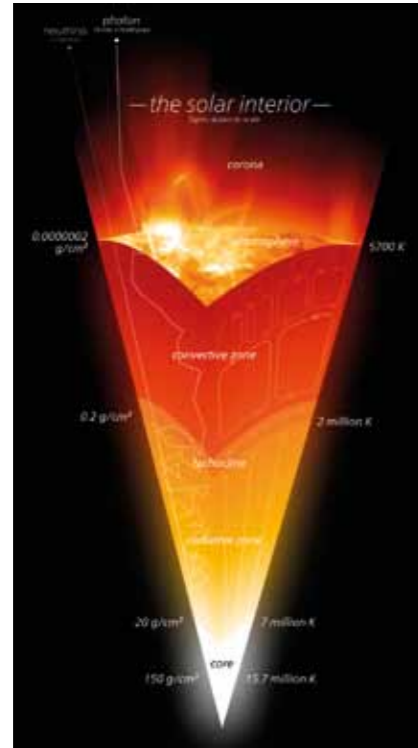

Solar structure. (source commons.wikimedia.org; author: Kelvinsong)

The Solar Spectrum

The range of the solar electromagnetic radiation extends from wavelengths shorter than 1 nanometre (1 nm = 10^{-9} metre) to wavelengths of several kilometres. Nearly half of the total energy emitted by the Sun falls within the narrow wavelength interval which corresponds to visible light (400 to 700 nm); the other half lies in the near infrared (700 to 4000 nm).

The solar spectrum has the general characteristic of a continuum spectrum, superposed with complex absorption features in the near ultraviolet and visible range (Fraunhofer structure), and emission features at shorter wavelengths. Using a spectroscope of his own manufacture, the German optician Joseph von Fraunhofer (1787-1826) discerned dark lines in the solar spectrum that would later be attributed to chemical constituents of the Sun.

The visible, near ultraviolet and infrared solar radiation originates from the photosphere. At shorter wavelengths, the emissions originate from the chromosphere and, at very short wavelengths from the upper chromosphere and the corona. This latter solar region is also responsible for the emissions at very long wavelengths (e.g. radio waves). Whilst the photosphere spectrum shows multiple absorption lines, the chromosphere spectrum is dominated by emission lines.

Fluctuations in the solar radiation are mainly confined to the ultraviolet spectral range and shorter wavelength regions where a high variability can exist, such as the radio wavelength range.

Heliosphere

The heliosphere is defined as the region of space surrounding the Sun, in which the solar wind, the solar magnetic field, and all of the ejections of matter from the Sun, play a greater role in controlling how plasma inside the solar system behaves, than the magnetic fields and plasmas from the rest of the Milky Way galaxy beyond.

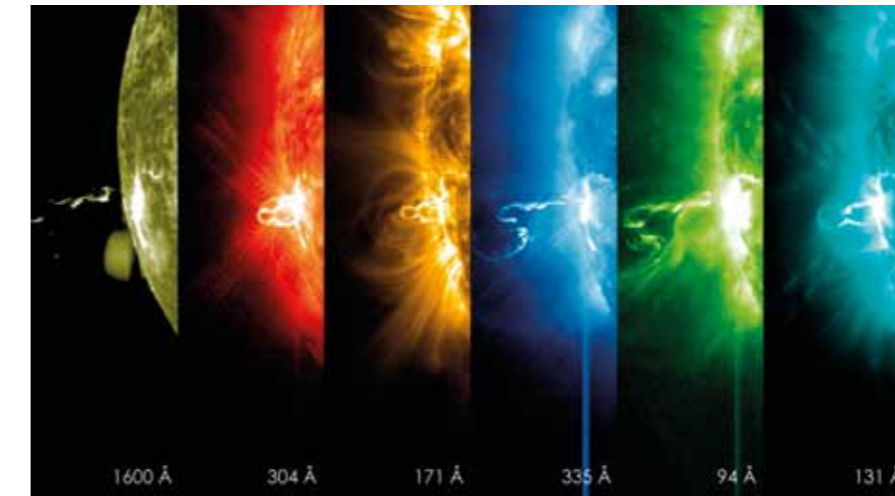

First moments of a solar flare at different wavelengths in the extreme ultraviolet (false color). (credit: NASA)

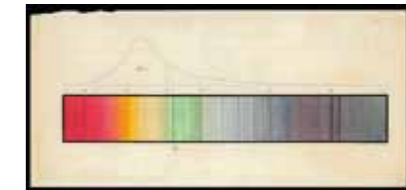

Solar spectrum with the absorption lines in black, as observed by Joseph von Fraunhofer. (courtesy Deutsches Museum.)

ULTRAVIOLET SOLAR IRRADIANCE AND ATMOSPHERIC PROCESSES

Paul C. Simon

At the top of the atmosphere, the solar spectrum nearly looks like the emission spectrum of a black body at about 6 000 K, the characteristic temperature of the Sun's photosphere. The 200-400 nm wavelength interval has been extensively discussed by Dietrich Labs and coworkers in 1987 when they reported the data obtained from the Spacelab I mission in 1983. Most of the UV radiation penetration in the atmosphere is controlled by molecular nitrogen and oxygen, ozone and, to a lesser extent at lower altitude, molecular scattering (Rayleigh scattering).

The absorption of the solar ultraviolet radiation heats the atmosphere, influencing its dynamics as well as its chemical structure. Precise knowledge of the ultraviolet solar irradiances is therefore needed to understand the chemical and physical processes taking place at different atmospheric altitudes.

Ultraviolet irradiance solar spectrum from 160 to 380 nm.

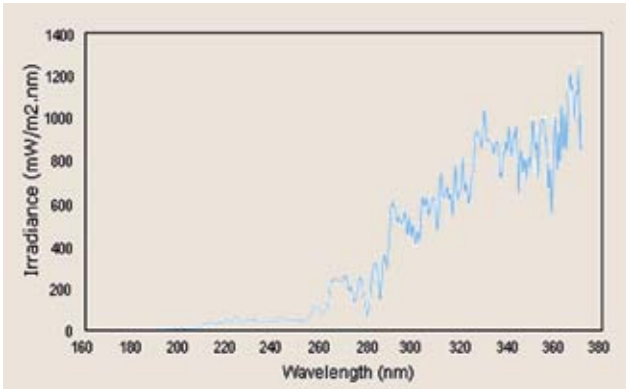

The absorption of solar ultraviolet radiation also dissociates atmospheric molecules producing atoms or different molecules. Some constituents loose electrons and become charged, thus forming the ionosphere which is responsible for radio wave propagation.

Ions and electrons result mainly from the photoionization of molecular nitrogen and oxygen, and of atomic oxygen by solar radiation shorter than about 100 nm, because these constituents strongly absorb in that wavelength range (see next section). The very intense chromospheric solar emission line of hydrogen at 121.6 nm (Lyman alpha) has to be taken into account for photoionization processes down to about 70-80 km. This line initiates also photodissociation, for instance, of water vapour in the mesosphere, controlling the ozone budget in this altitude range through the production of hydroxyl radicals.

Molecular oxygen is mainly photodissociated in the range of 135 to 175 nm in the lower thermosphere determining consequently the heating rate in that region and the production of atomic oxygen. Much of the atomic oxygen is transported down to the mesopause and its density must be correctly known as an essential input to middle atmosphere studies.

The 175-200 nm wavelength range corresponds to the Schumann-Runge absorption bands of molecular oxygen and is directly related to its photodissociation in the mesosphere and the upper stratosphere. The 200 - 242 nm range corresponds to the Herzberg absorption continuum of molecular oxygen. Its photodissociation yields to atomic oxygen responsible for ozone production in the stratosphere through the Chapman mechanism.

The primary ozone absorption takes in the 200-310 wavelength range in the strong Hartley band and is responsible for heating the stratosphere. Its absorption is much less important beyond 310 nm (Huggins bands) and extends until the visible and near infrared ranges.

The absorption processes are of utmost importance for life on Earth since they completely shield the biosphere from highly energetic UV-C (wavelengths less than 280 nm) and from most of the UV-B (wavelengths between 280 and 315 nm). The cut-off wavelength is determined by the total amount of ozone in the stratosphere.

Most of the solar radiation that reaches the surface is converted into heat. About 50% of the incident solar irradiance is either backscattered by atmospheric molecules, aerosol and clouds, or absorbed by trace gases such as water vapour, ozone and carbon dioxide.

In the sixties, solar UV irradiances were badly known and several balloon, rocket and, since the eighties, orbital measurements on board Spacelab were performed by BIRA-IASB. They are currently carried out with the SOLSPEC experiment on board the International Space Station (ISS, see chapter 8).

Selected References

Labs, D., H. Neckel, P.C. Simon and G. Thuillier, "Ultraviolet solar irradiance measurement from 200 to 358 nm during Spacelab I mission.", Solar Physics (ISSN 0038-0938), vol. 107, no. 2, 1987, p. 203-219.

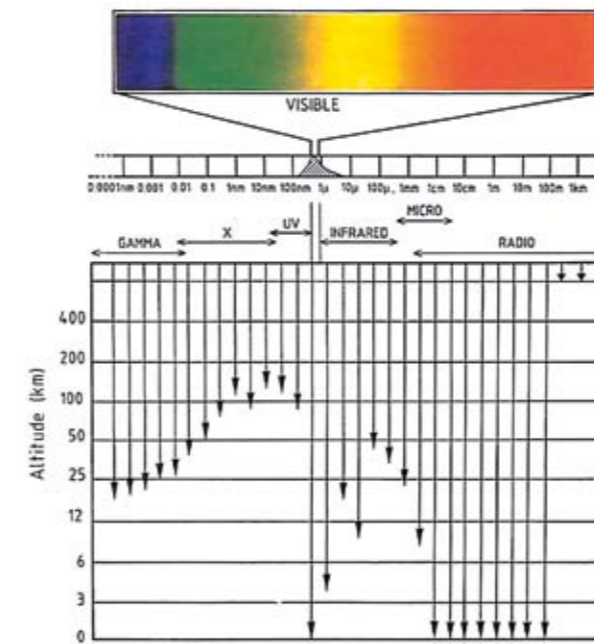

Altitude of solar radiation penetration in the terrestrial atmosphere.

SOLAR ULTRAVIOLET IRRADIANCE VARIABILITY

Paul C. Simon

The amount of radiation emitted by the Sun varies on many time scales. They may be as short as seconds or less for flares, weeks for variations associated to the solar rotation, decades for the solar activity cycle or secular. Two time scales are generally considered in relation with aeronomic studies: the 11-year activity cycle and the 27-day variation cycle. For both cycles, most of the variability occurs in the ultraviolet part of the solar electromagnetic spectrum, which directly affects the atmosphere.

Because of the difficulty in quantifying the solar irradiance variation related to the solar activity cycle in the eighties, the impact on the atmosphere of the 27-day variation was analysed in detail. Indeed, observations over short scale periods are far more accurate in that they avoid the aging problem of the observing instrumentation in orbit. These studies were very useful for the validation of photochemical processes.

The 27-Day Variation

As areas of enhanced magnetic activity appear and disappear on the solar disk, they look like “search lights” beams by the slow 27-day rotation period of the Sun. The observed cycle thus arises from the rotation of the Sun and the non-uniform distribution of activity on the solar disc.

The best description of the 27-day variations during the declining phase of solar cycle 21 in the eighties have been provided by the Solar Mesosphere Explorer (SME) from 115 to 210 nm and by the Solar Backscatter Ultraviolet Radiometer (SBUV) observations from 210 to 300 nm. Both satellite observations have been extensively analysed, using the Fast Fourier Transform technique (FFT) to isolate the solar flux modulation related to the 27-day solar rotation. The agreement between the amplitude of 27-day variations during the overlapping period of time is very good.

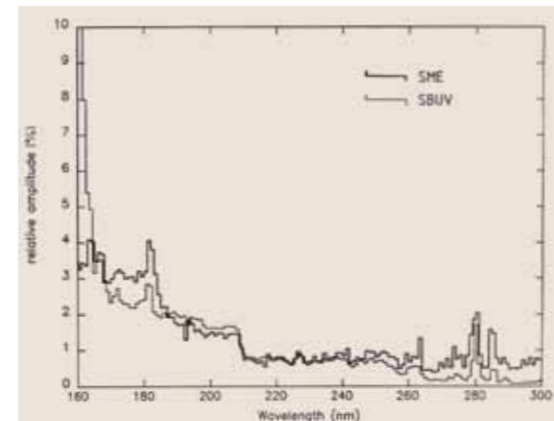

Comparison of 27-day variation deduced from SME and SBUV observations, as a function of wavelength.

Solar Cycle Variations

One of the most noticeable phenomena of solar activity is the appearance and disappearance of dark spots on the surface of the Sun, which occurs at the rhythm of ten to twelve years, with an average of eleven years. Sunspots mark the growth and decrease of solar activity. At the same time, the solar magnetic field reverses.

The amplitude of UV solar variation associated with the 11-year activity cycle was uncertain for a long time. Indeed, the SBUV spectrometer suffered from severe aging problems, mainly in the reflectivity of the diffuser plate used for solar irradiance measurements, making difficult quantitative analyses of the 11-year solar cycle variation. A new generation of instruments with in-flight calibration procedures has tackled successfully this issue. The SOLar Stellar Irradiance Comparison Experiment (SOLSTICE) and the Solar Ultraviolet Spectral Irradiance Monitor (SUSIM) were launched on board the Upper Atmospheric Research Satellite (UARS) in 1991. The Solar Radiation and Climate Experiment (SORCE), follow-up of SOLSTICE, was launched on January 25, 2003. BIRA-IASB is involved in the Solar Spectrum (SOLSPEC) experiment on board the ISS in operation since 2008 (see chapter 8). Its observation time has been extended until 2017.

The Maunder Minimum, also known as the “prolonged sunspot minimum”, also known as the Little Ice Age, is the name used for the period starting in about 1645 and continuing to about 1715 when sunspots became exceedingly rare, as noted by solar observers of the time.

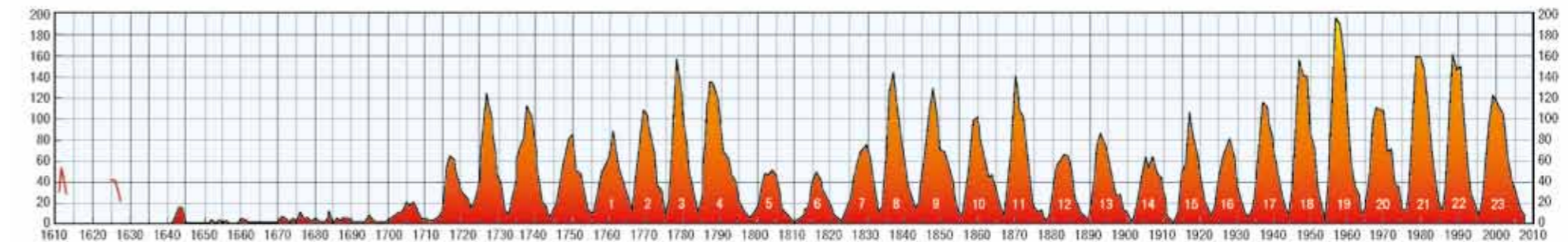

Time series of the sunspot numbers illustrating the Maunder Minimum in the seventeenth century. (credit: NASA)



Drawing of sunspot group observed on 17 June 1875.

SOLAR WIND

Viviane Pierrard and Joseph Lemaire

The solar wind is a stream of charged particles (ions and electrons) that are continuously escaping from the Sun into the interplanetary medium. The existence of a continuous stream of particles flowing outward from the Sun was first suggested by British astronomer Richard Carrington who made the first observation of a very high solar flare in 1859 and suspected a connection with the geomagnetic storm observed on the following day at the Earth. In 1950, the German scientist Ludwig Biermann postulated the solar wind outflow by observing the tails of comets pointing away from the Sun. First direct measurements in situ could be performed since 1959 by the Soviet satellites Luna and 1962 by the American Mariner 2 spacecraft. This opened an important field of research, since it is essential to know solar wind characteristics for safe interplanetary space travel and for determining the influence of these particles on the space environment of the Earth.

Kinetic Models

Pioneer solar wind kinetic models were developed since 1969 at BIRA-IASB by Joseph Lemaire and Marc Scherer. They developed exospheric models appropriate to describe the collisionless solar wind. They determined the right polarization electric field to be used for an expanding atmosphere like the solar corona. Lemaire and Scherer's kinetic models complement the famous hydrodynamic description developed in 1958 by Parker who pioneered the first explanation for the acceleration of coronal protons to supersonic velocities. Nevertheless, the hydrodynamic analogy is viewed as inadequate beyond 3-5 R_s where the Coulomb mean-free-paths of the electrons and ions become larger than the local density scale height. The improved kinetic descriptions of the coronal expansion demonstrated that the physical process involved in the solar wind acceleration is basically determined by the electric potential distribution that drags the ions out of the corona conferring them supersonic velocities at the radial distance of the Earth (1 AU). The differences and complementarities of hydrodynamic and kinetic models of the solar corona and wind have been outlined in comprehensive reviews by several authors at BIRA-IASB. The solar wind kinetic model will be extended to the three-dimensional case in the framework of the interuniversity project CHARM.

Suprathermal Electrons

The velocity distribution functions (VDF) of electrons observed in the solar wind are characterized by a core and a halo population of slightly more energetic particles. A positive correlation between the solar wind bulk speed at 1 AU and the escape flux of energetic electron (inferred from Ulysses and WIND measurements) clearly supports the theoretical finding that the presence of suprathermal electrons influences the mechanism of solar wind acceleration. Indeed, Viviane Pierrard showed that the electric field, as well as the maximum

solar wind velocity, is enhanced when the concentration of suprathermal electrons is increased in the solar corona. The enhancement of the escape flux of suprathermal electrons can account for the fast solar wind regime originating from coronal holes. The fast wind can be modelled by assuming for instance a Kappa velocity distribution function for the coronal electrons at the exobase where they become almost collisionless.

The presence of VDFs with power law energy spectra in many other space plasmas suggests that the creation of such suprathermal tails in VDFs is probably a rather universal physical process. Pierrard also pointed out how the coronal temperature profiles and the heat flux are influenced by the addition of a population of suprathermal electrons at the bottom of the solar corona.

Solar Corona

In collaboration with Lamy, Pierrard showed that the heavy minor ions are preferentially heated in the corona by velocity filtration, but that they are less accelerated in the solar wind.

Recently, Lemaire expanded a method introduced by Alfvén to determine the coronal electron temperature distribution from radial electron density profiles that are derived from photometric measurements of coronal brightness observed during solar eclipses.

Effects of Coulomb Collisions and Wave-particle Interactions

More sophisticated solar wind models have been developed step by step at BIRA-IASB in a privileged collaboration with the team of Nicole Meyer-Vernet and Milan Maksimovic of the Observatoire de Paris-Meudon. Coulomb collisions between the electrons were first taken into account in the right hand side of the Fokker-Planck equation. These kinetic models of fourth generation confirmed that the collisions change the temperature anisotropy of the solar wind VDF but not the averaged values of their lower order moments. More recently, wave turbulence has been added in the Fokker-Planck equation of the coronal electrons. It has been found that whistler turbulence influences the diffusion of the pitch angles and kinetic energies of the solar wind electrons. This additional physical mechanism should play a role in the formation of the suprathermal tails of the electrons, at least in certain parts of solar wind where a powerful whistler wave spectrum might be present. For protons, kinetic Alfvén waves have been suggested by Yuriy Voitenko to create the often-observed proton beam aligned with the interplanetary magnetic field direction.

Ulysses

In the 1990s, the Ulysses spacecraft explored the interplanetary medium above the polar regions of the Sun during minimum solar activity conditions. This emphasized the significant differences between the solar wind at high heliographic latitudes and the properties of the solar wind plasma in the region of equatorial streamers. Michel Roth and Johan De Keyser brought an important contribution to the space community by relating WIND observations at 1 AU and Ulysses observations at 5 AU to determine the links between the solar wind at different radial distances.

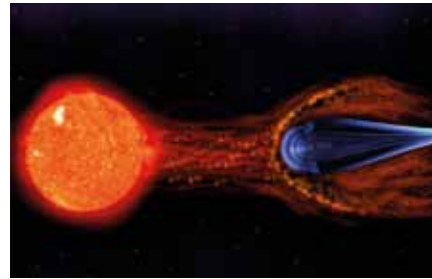

Artistic view of the solar wind and its influence on the space environment of the Earth.

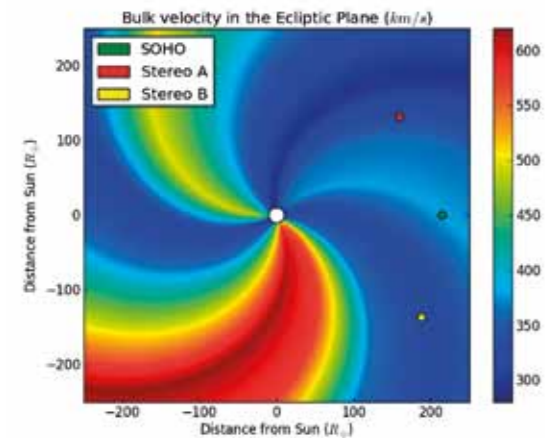

Bulk velocity of the solar wind particles in the ecliptic plane during the Carrington rotation 2075 obtained with the model developed at BIRA-IASB. The position of different spacecraft is also indicated. The Sun's rotation gives to the magnetic field streamlines a spiral shape.

The occurrence frequencies of different types of directional discontinuities (tangential and rotational discontinuities, magnetic holes) in the solar wind were also studied at BIRA-IASB using magnetic field measurements from the EXPLORER 43 interplanetary probe. When Lemaire visited NASA in 1975 as a Senior Research Associate of the US National Academy of Sciences, he extended the kinetic theory of diamagnetic boundary layers. This new kinetic model of tangential discontinuities was extended in Roth's PhD thesis where it was applied to the magnetopause.

Solar Energetic Particles (SEP)

Knowledge of the Solar Energetic Particle (SEP) environment constitutes a priority requirement for astrophysics missions and human exploration. SEP events are studied at BIRA-IASB by Norma Crosby and Mark Dierckx. They are detected in interplanetary medium and consist of electrons, protons, and heavier ions with energies from dozen of keVs to GeV. SEP events result from the acceleration of particles either by solar flares, by interplanetary shocks driven by Coronal Mass Ejections (CMEs) or by shocks associated with corotating interaction regions.

Conclusions and Perspectives

By studying solar wind observations and developing kinetic models, the solar wind team at BIRA-IASB contributed to a better understanding of the physical mechanisms of particle acceleration, the eruption site conditions and properties of the space environment. The heating of the solar corona to peak temperatures of more than a million Kelvin is a field of interest that continues to be investigated at BIRA-IASB. Three-dimensional models of the solar wind, the complementarity between the fluid and kinetic approaches, and the links between the heliosphere and other astrophysical bodies are elements of ongoing projects with Belgian Universities.

Selected References

De Keyser, J., M. Roth, J. Lemaire, B. T. Tsurutani, C. M. Ho and C. M. Hammond (1996), Theoretical plasma distributions consistent with Ulysses magnetic field observations in a solar wind tangential discontinuity, *Solar Physics*, 166(2), 415-422, doi:10.1007/BF00149407.

Echim, M., J. Lemaire and Ø. Lie-Svendsen (2010), A Review on Solar Wind Modeling: Kinetic and Fluid Aspects, *Surveys in Geophysics*, 32(1), 1-70, doi:10.1007/s10712-010-9106-y.

Lemaire, J. and V. Pierrard (2001), Kinetic models of solar and polar winds, *Astrophysics and Space Science*, 277(1-2), 169-180, doi:10.1023/A:1012245909542.

Lemaire, J. and M. Scherer (1973), Kinetic models of the solar and polar winds, *Reviews of Geophysics*, 11(2), 427-468, doi:10.1029/RG011i002p00427.

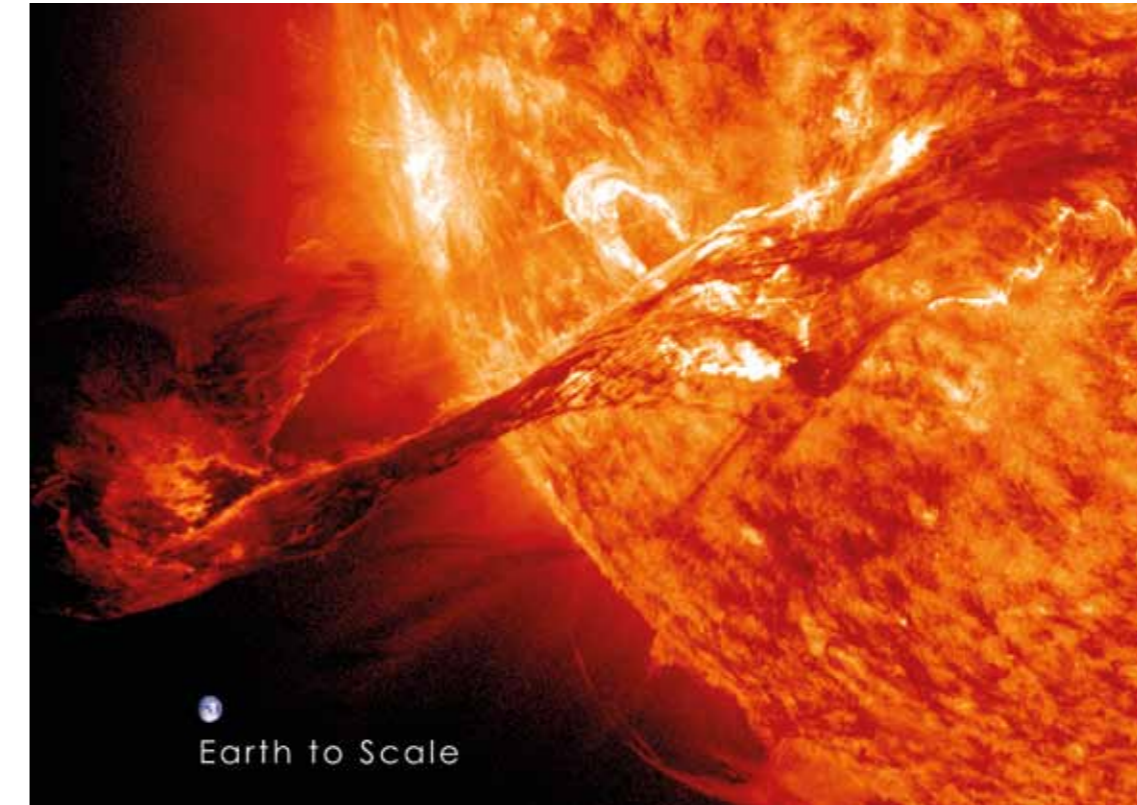

Coronal mass ejection. (credit NASA)

Maksimovic, M., V. Pierrard and J. F. Lemaire (1997), A kinetic model of the solar wind with Kappa distribution functions in the corona, *Astronomy and Astrophysics*, 324(2), 725-734.

Pierrard, V. and H. Lamy (2003), The Effects of the Velocity Filtration Mechanism on the Minor Ions of the Corona, *Solar Physics*, 216(1-2), 47-58, doi:10.1023/A:1026157306754.

Pierrard, V. and M. Lazar (2010), Kappa Distributions: Theory and Applications in Space Plasmas, *Solar Physics*, 287(1-2), 153-174, doi:10.1007/s11207-010-9640-2.

Pierrard, V. and J. Lemaire (1996), Lorentzian ion exosphere model, *Journal of Geophysical Research: Space Physics*, 101(A4), 7923-7934, doi:10.1029/95JA03802.

Pierrard, V. and Y. Voitenko (2013), Modification of Proton Velocity Distributions by Alfvénic Turbulence in the Solar Wind, *Solar Physics*, 288(1), 355-368, doi:10.1007/s11207-013-0294-8.

Website

Solar Wind Research at BIRA-IASB:
<http://www.aeronomie.be/en/topics/solarsystem/solarwind.htm>

4

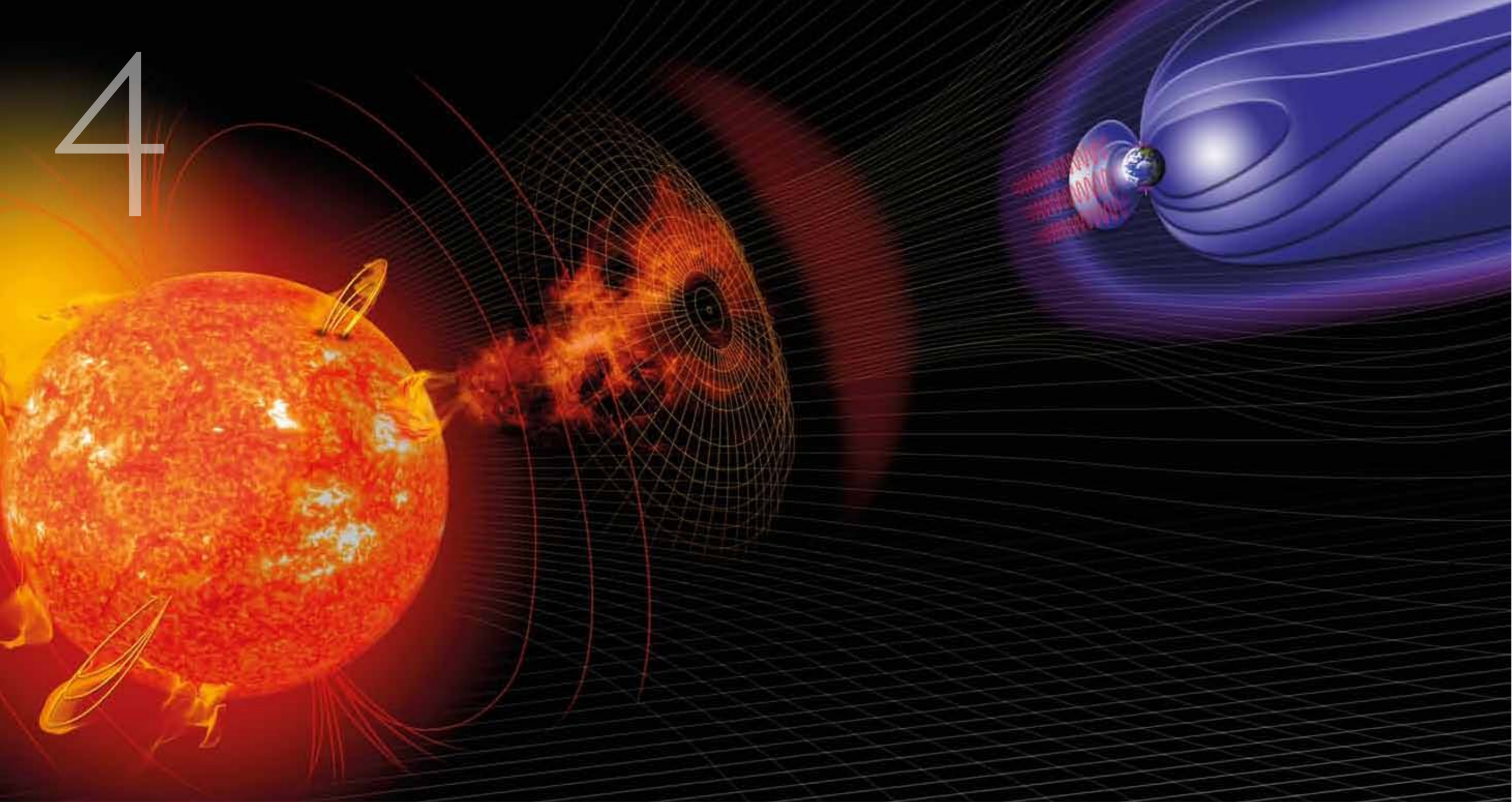

BEELGISC HINSTITUUT VOOR RUIMTE-AERONOMIE (BIRA) IN INSTITUUT D'AERONOMIE SPATIALE DE BELGIQUE (IASB) BELGIAN INSTITUTE FOR SPACE AERONOMY (BIRA) INSTITUTE FOR SPACE AERONOMY (IASB) BELGISC HINSTITUUT VOOR RUIMTE-AERONOMIE (BIRA) INSTITUUT D'AERONOMIE SPATIALE DE BELGIQUE (IASB)

THE MAGNETOSPHERE: FROM FIRST DISCOVERIES TO CURRENT RESEARCH

Johan De Keyser

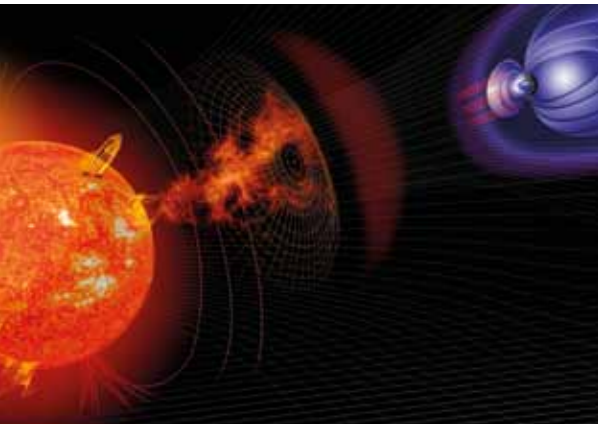

Artist view of the relationship between Earth and Sun. (credit: NASA)

Johan De Keyser

The Sun sends out a continuous magnetized flow of charged particles into interplanetary space, known as the solar wind. Earth's internally generated magnetic field, which can be approximated by a magnetic dipole that is tilted about 10° with respect to the Earth's rotation axis, appears to be rather impermeable to these particles and carves out a magnetic cavity in interplanetary space, called the magnetosphere. The magnetosphere is bounded from below by the upper atmosphere, and in particular the ionized upper atmosphere, commonly known as the ionosphere.

The solar wind determines the overall shape of the magnetosphere. As the solar wind varies on widely different time scales, from seconds to centuries, the magnetosphere actually is a very dynamic structure. At the same time, the Sun's electromagnetic radiation (in particular ultraviolet radiation up to X-rays, the most energetic part of the solar spectrum) is responsible for producing most of the ionization of the Earth's upper atmosphere.

Therefore, both the Sun's corpuscular and electromagnetic radiation control the state of the closely coupled magnetosphere – ionosphere system. In this chapter, we take a look at the different elements in this system, all of which have been and continue to be active research domains of the Belgian Institute for Space Aeronomy.

THE MAGNETOSPHERE

Johan De Keyser

The magnetised solar wind and the gas in the magnetosphere are almost completely ionized: they consist essentially of charged particles. Charged particles are much more mobile along magnetic field lines than across them, so both media do not readily mix. The magnetosphere therefore forms an obstacle to the solar wind flow. Moreover, this flow is supersonic (and even super-Alfvénic) and thus resembles the flow around a supersonic jet. The magnetic field plays a similar role in structuring the magnetospheric gas, as different regions are formed that do not easily mingle.

The solar wind transitions from supersonic to subsonic speeds at the bow shock. The shocked and heated solar wind there feels the presence of the downstream obstacle and it deviates and flows around the magnetosphere, forming the magnetosheath. The nearly impermeable interface between the interplanetary magnetic field and plasma of solar origin on the one hand, and the geomagnetic field lines and plasma of ionospheric origin on the other hand, is called the magnetopause. The US Explorer 12 mission in 1961 for the first time revealed an abrupt magnetic field change as the spacecraft left the geomagnetic field and entered the solar wind in the magnetosheath, crossing the magnetopause and leaving the magnetosphere for the first time. The magnetopause carries an electric current associated with the magnetic field change across the interface. The solar wind pressure compresses the magnetosphere at the day side. The subsolar magnetopause standoff distance is $10 R_E$ (Earth radii) on average. On the night side, however, the magnetosphere is stretched out into a long magnetotail that is more than $200 R_E$ long. This tail consists of two lobes, which are nearly empty, the northern one with a magnetic field pointing towards Earth, the southern one with a field pointing away from Earth. Both are separated by a current sheet that matches the field reversal; this current sheet is embedded in a denser plasma sheet.

The plasma inside the magnetosphere comes from two sources. First, the magnetopause is not exactly impermeable. Various processes do allow solar wind plasma to cross the magnetopause. This plasma forms a boundary layer just inward of the magnetopause, called the low-latitude boundary layer on the day side, while it is called the mantle at high latitudes on the night side. The field lines in this boundary layer all extend down into the cusps, which play an important role in plasma entry. The second source of plasma is the ionosphere, the ionized upper atmosphere.

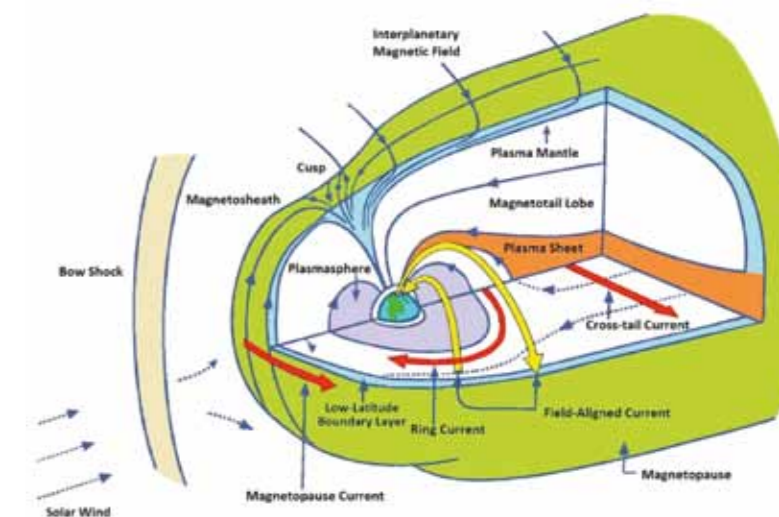

Sketch of the magnetosphere. See text for a description of its most important regions. (adapted from Kivelson and Russell, 1995)

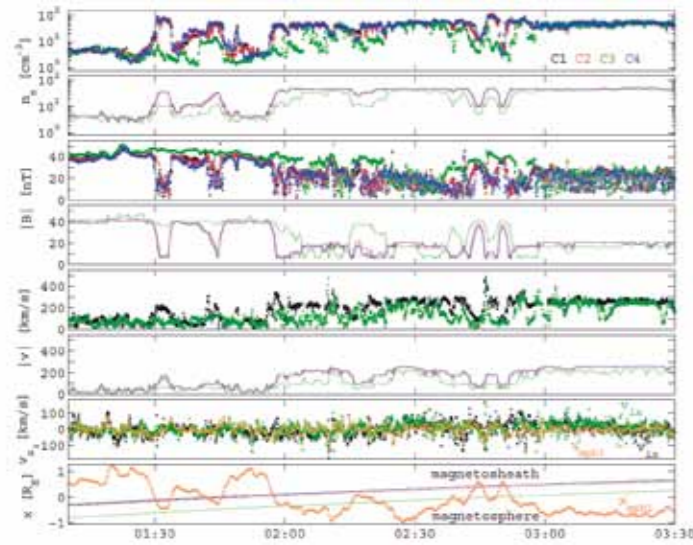

Reconstructed motion of the magnetopause based on observations from the four Cluster spacecraft on 6 June 2001. The panels show time series of the observed and reconstructed electron density n_e , magnetic field strength $|B|$, and plasma velocity $|v|$.

The bottom panel shows the four spacecraft trajectories relative to the reconstructed position of the magnetopause.

For instance, low/high n_e and strong/weak $|B|$ correspond to the spacecraft being inside and outside the magnetosphere, respectively; the relative positions explain the differences in the observations by the 4 spacecraft.

Magnetospheric research at the Institute initially dealt with the question: how can ionospheric plasma move upward to form the magnetosphere? This led to the study of the polar wind: ionospheric material (mostly H^+ , He^+ , and O^+) that moves out into essentially empty space along the geomagnetic field lines – the situation that one encounters at high magnetic latitudes, above the polar caps [Lemaire and Scherer, 1970]. The situation is a bit more complicated at lower latitudes, where the geomagnetic field lines are closed so that the plasma is trapped. As the degree of ionisation varies with daylight conditions due to the strong photo-ionisation effect of solar UV on the upper atmosphere, plasma moves up during the day time, only to descend again during the night time. The high-altitude reservoir that is formed in this way is the plasmasphere with its cold dense plasma content. This region has been an important field of research for the Institute ever since and is discussed in detail in next section.

While the magnetosphere is bounded by the atmosphere from below, its interaction with the solar wind determines the nature of its outer boundary. The BIRA-IASB magnetospheric physics team has been addressing this topic extensively, both from the theoretical and the observational side. First came theoretical work based on plasma boundaries such as the magnetopause – the interface between plasma of magnetospheric origin and solar wind plasma. Early observations indicated that this boundary is very dynamic, and that a certain amount of solar wind plasma actually is able to traverse that boundary. This led to the development of the “impulsive penetration” model for solar wind plasma entry, a topic that is still under scrutiny. Other studies looked at the possible enhanced diffusion of plasma across the magnetopause due to the role of plasma waves and their amplification near the magnetopause. As detailed observations of this boundary became available, especially with the advent of ESA’s 4-spacecraft Cluster mission, the confrontation of the theory with the observations became a more important theme. An example of this was the introduction of empirical reconstruction techniques, which allow to track the continuously oscillating motion of the magnetopause due to solar wind pressure variations, and to infer true spatial profiles of the plasma and field parameters across the magnetospheric boundary.

Some of the magnetospheric plasma eventually returns to Earth. A prime example are the plasma particles that are responsible for aurora (northern and southern polar lights). These phenomena have their sources at a generator site in the magnetosphere. Such sources act as a voltage source of the associated auroral electric circuit. BIRA-IASB is at present still very much active in studying this electric circuit and possible generator sites. This includes observations of those generators at the low latitude boundary layer, in the plasma sheet and plasma sheet boundary layer, above the polar caps, and observations of the down going particles, but also of the ionospheric effects and the characteristics of the enhanced ionospheric outflow they produce (see next section).

While the solar wind particles and the plasma of ionospheric origin tend to be rather cold, a fraction of these particles can be energised due to various acceleration processes, often in relation to geomagnetic disturbances known as magnetospheric substorms and storms. This can be electrostatic acceleration as in aurora, adiabatic acceleration as it occurs during inflow of plasma from the magnetospheric tail during a substorm, or acceleration by induced electric fields during storms and strong compressions of the magnetospheres. In addition, there may be energetic particles penetrating the magnetosphere from outside, such as those produced during solar energetic particle events, or the entry of cosmic rays. All these processes contribute to the formation of the radiation belts, energetic particle reservoirs that encircle the Earth, that were discovered by Van Allen at the dawn of the Space Age, and that are still of enormous technological interest because of their harmful effects on man and machine in near-Earth space.

Through the study of mass input and loss at the ionospheric boundary, and of mass transfer across the magnetospheric boundary, we are beginning to come to grips with the overall mass circulation in the magnetosphere. This is fundamental for our understanding of the Earth’s magnetosphere over a longer time scale. It also helps us to understand the differences between the magnetospheres of the Earth, Mercury, Venus and Mars, of the giant planets, and of minor solar system bodies such as comets. These studies are presently carried out in the context of the Interuniversity Attraction Pole “Planets: Tracing the Transfers, Origin, Preservation, Evolution of their Reservoirs” and the ESA Rosetta project. Such comparative studies integrate magnetospheric studies in the broader picture of planetary evolution.

Selected References

De Keyser, J., M.W. Dunlop, C. J. Owen, B. U. Ö Sonnerup, S. E. Haaland, A. Vaivads, G. Paschmann, R. Lundin and L. Rezeau (2005), Magnetopause and Boundary Layer, *Space Science Reviews*, 118(1-4), 231-320, doi:10.1007/s11214-005-3834-1.

Echim, M., R. Maggiolo, J. De Keyser, T. L. Zhang, G. Voitu, S. Barabash and R. Lundin (2011), Comparative investigation of the Terrestrial and Venusian magnetopause: kinetic modeling and experimental observations by Cluster and Venus Express. *Planetary and Space Science*, 59(10), 1028-1038, doi:10.1016/j.pss.2010.04.019.

Kivelson, M. G. and C. T. Russell (Eds.) (1995), *Introduction to Space Physics*, Cambridge University Press, Cambridge, U.K.

Lemaire, J. and M. Roth (1978), Penetration of solar wind plasma elements into the magnetosphere, *Journal of Atmospheric and Terrestrial Physics*, 40(3), 331-335, doi:10.1016/0021-9169(78)90049-1.

Lemaire, J. and M. Scherer (1970), Model of the polar ion-exosphere, *Planetary and Space Science*, 18(1), 103-120, doi:10.1016/0032-0633(70)90070-X.

Roth, M., J. De Keyser and M. M. Kuznetsova (1996), Vlasov theory of the equilibrium structure of tangential discontinuities in space plasmas, *Space Science Reviews*, 76(3-4), 251-317, doi:10.1007/BF00197842.

THE PLASMASPHERE

Joseph Lemaire and Viviane Pierrard

The plasmasphere is a characteristic region of the magnetosphere filled with dense ionospheric plasma. Its outer surface, the plasmopause, was discovered in 1963 by Donald Carpenter from ground-based radio measurements of whistler waves. It encircles Earth and extends from the topside ionosphere up to $3 R_E$ (Earth radii) or more in the equatorial plane. The shape and extent of the plasmasphere depends strongly (i) on the level of geomagnetic activity, which is quantified by the planetary Kp-index, (ii) on magnetic local time (MLT) and (iii) on universal time (UT). The plasmasphere is filled with thermal electrons, protons, and other charged particles of ionospheric origin whose energies are less than 1-2 eV. They spiral along the geomagnetic field lines, and revolve around the Earth with an angular velocity almost equal to that of the Earth since these charged particles are trapped within the gravitational and the geomagnetic fields.

Inside the plasmasphere the electron and ion densities decrease smoothly along geomagnetic field lines and with radial distance up to the plasmopause, where a sharper decrease is generally observed in the radial density profile. Beyond the plasmopause, the plasma density drops from about 300 cm^{-3} to less than 10 cm^{-3} over radial distances sometimes as short as $0.1 R_E$. This sharp density gradient has been consistently observed by space probes since the early Russian Lunik missions, as well as from whistler wave analysis mainly conducted in the US and France. Detailed analysis of whistler waves propagating along geomagnetic field lines from one hemisphere to the other allowed to determine how the plasmopause position changes as a function of MLT and UT during geomagnetic activity variations. The main results of whistler wave campaigns have been summarized in the highly cited book of Lemaire and Gringauz in 1998.

At BIRA-IASB, Joseph Lemaire became interested in studying the plasmasphere from whistler and satellite observations in 1974. This led him to propose a theory for the formation of the plasmopause. The physical mechanism proposed for peeling off the plasmasphere is based on plasma interchange motion becoming convectively unstable from time to time. Indeed, during magnetospheric substorm onsets the plasma in the outermost layers of the post-midnight plasmasphere is accelerated eastward due to sudden enhancements of the convection velocity. The stronger the eastward acceleration, the steeper the density gradient will be in the midnight-to-dawn plasmopause boundary layer. This is precisely what had been found in 1970 from OGO-5 in situ observations. Both satellite and ground-based whistler observations definitely support this theory as documented in numerous publications. For instance, in 1979 Kowalkowski and Lemaire identified broad plasma irregularities in the post-midnight MLT sector just outside the plasmopause in H⁺ density

profiles observed by OGO-5. They interpreted these large scale structures as elements of plasma detached from the nightside plasmasphere, precisely where the interchange instability has a maximum growth rate according to Lemaire's theory. Note that none of the magnetohydrodynamic scenarios for the evolution of the plasmasphere can explain such observations and achieve complete detachment of plasma irregularities. Furthermore, none of the earlier scenarios for the formation of the plasmopause are able to account for the sharp density gradient observed beyond the plasmopause.

Fabien Darrouzet studied the plasmasphere from the experimental point of view. He examined plasmaspheric density gradients from multi-spacecraft measurements made by the WHISPER experiment on board the Cluster spacecraft in order to determine the local orientation of the plasmopause surface and the structure of plasmaspheric plumes and density irregularities inside the plasmasphere. Plasmaspheric plumes are protrusions of the plasmasphere that develop as a consequence of geomagnetic activity, and have been imaged with NASA's IMAGE spacecraft. Together with colleagues, he studied various aspects of the plasma refilling process, i.e. how the ionospheric plasma fills the plasmaspheric flux tubes. In doing so, he brought data from ESA's Cluster and NASA's IMAGE missions together. An updated compilation of the discoveries made with both missions regarding the plasmasphere has been published in 2009 in a book edited by BIRA-IASB scientists, as a follow-up of a workshop organized in 2007 at the Institute.

The changes in the shape of the plasmopause and its dependence on the Kp-index have extensively been observed with radio instruments recording whistler waves, and by satellites. All these observations indicate that the plasmopause is closer to Earth in the post-midnight region than at other magnetic local times. These observations also indicate that a bulge in the plasmopause surface is sometimes forming at dawn and subsequently evolves into a plasmaspheric plume as it corotates to the afternoon or dusk sectors and to the night side, as predicted by Lemaire. These features have clearly been verified by numerical simulation. Time-dependent simulations of plasmasphere erosion based on the interchange mechanism were developed using different electric and magnetic field models. They were confronted to actual plasmopause positions obtained from satellite and whistler observations during substorms and geomagnetically quiet periods. These comparisons show that, most of the time, simulations based on the interchange instability qualitatively fit the in situ observations better than alternative MHD scenarios. BIRA-IASB's dynamical simulations have also been successfully compared to EUV/IMAGE observations, in particular with respect to the peeling-off mechanism due to the interchange instability. The formation of ripples or shoulders in the plasmopause in the post-dawn sector during substorms, and their subsequent propagation and stretching into plasma tails or plumes, had already been simulated in 1985 by Lemaire's first dynamical model, decades before they were effectively seen in the EUV/IMAGE observations. Multiple plasmapauses have often been reported from whistler measurements as well as from in-situ satellite observations; the formation of an intermediate region between an old vestigial

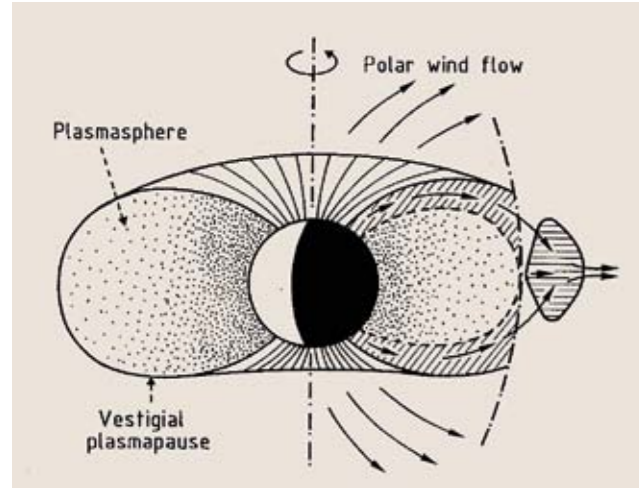

Erosion of the plasmasphere during a geomagnetic storm due to the interchange instability mechanism developed at BIRA-IASB. According to this mechanism, plasma elements are detached in the post-midnight sector due to enhanced magnetospheric convection velocity there. (from Lemaire, 1974)

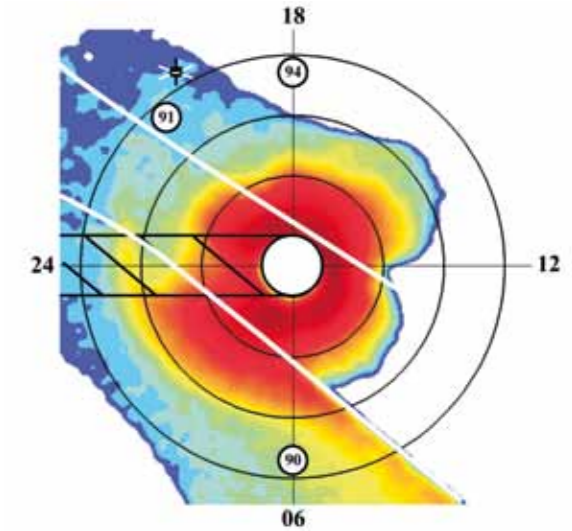

Equatorial projection of a plasmasphere image from the NASA IMAGE/EUV instrument at 08:31 UT on 7 May 2002. The white disk in the center of the image corresponds to the Earth, with its shadow extending to the left, away from the Sun. The three circles are at 3, 5 and 7 Earth radii. The formation of the plasmaspheric plume visible in the night sector was also observed by the Cluster satellites, as well as the geosynchronous LANL 1990-095, LANL 1991-080 and LANL 1994-084 satellites, whose positions are indicated. (from Darrouzet et al., 2006)

plasmopause and a new one that is formed at larger distances during a subsequent less severe substorm event has also been simulated by Lemaire and Pierrard.

More recently, a three-dimensional dynamical model of the plasmasphere has been developed at the Institute. This dynamical 3D model can be used to forecast and nowcast the plasma density in the plasmasphere and in the plasmatrough. It is continuously running on the European Space Weather Portal web site. It has also been imported at NASA's Community Coordinated Modeling Center. This plasmaspheric model has recently been coupled to an ionospheric model by Viviane Pierrard and Kris Borremans.

In 1992, Lemaire and Schunk suggested the existence of a plasmaspheric wind, a continuous expansion of the plasmasphere, similar to the expansion of the solar corona. Their theoretical argument in favor of a slow but continuous hydrodynamic expansion of the plasmasphere was inferred from the equatorial density profiles observed by OGO-5 and the comparison with those of a corotating exosphere in hydrostatic equilibrium. This plasmaspheric wind was finally observed with the Cluster/CIS experiment by Dandouras in 2013.

Much of the recent observational work on the plasmasphere has been done with the Cluster spacecraft (see section "Cluster", chapter 8). These spacecraft are ageing. To guarantee continued access to plasmaspheric observations, the Institute has set up a Very Low Frequency antenna in Humain, Belgium, for the observation of whistlers. This antenna is part of the AWDANet (Automatic Whistler Detector and Analyzer Network) network of whistler stations.

The key contributions of BIRA-IASB in analyzing observations and building models of the plasmasphere and of the plasmopause, of shoulders or plumes, of the plasmaspheric wind and of the refilling process of plasmatrough flux tubes, represent important steps in advancing the scientific understanding of the plasmasphere. Of course, there are still a number of open issues in need of further research.

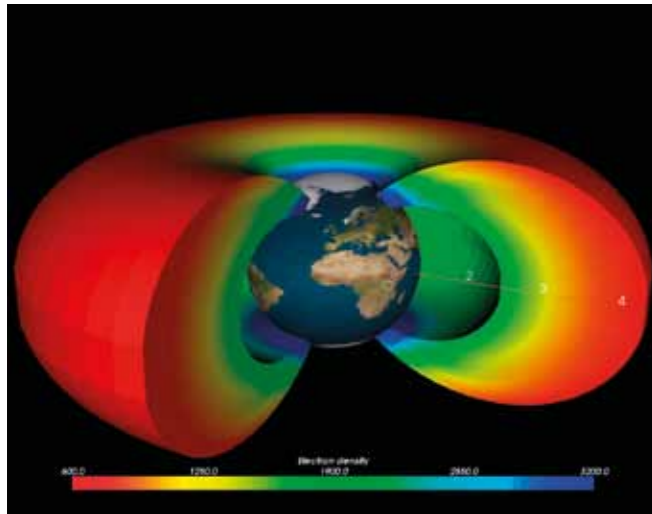

Quiet-time electron number density computed with the dynamical 3D model of the plasmasphere model developed at BIRA-IASB. (from Pierrard and Stegen, 2008)

Selected References

Dandouras, I. (2013), Detection of a plasmaspheric wind in the Earth's magnetosphere by the Cluster spacecraft, *Annales Geophysicae*, 31(7), 1143-1153, doi:10.5194/angeo-31-1143-2013.

Darrouzet, F., J. De Keyser and V. Pierrard (Eds.) (2009), *The Earth's Plasmasphere: A CLUSTER and IMAGE Perspective*, Springer, Berlin.

Darrouzet, F., J. De Keyser, P. M. E. Décréau, D. L. Gallagher, V. Pierrard, J. F. Lemaire, B. R. Sandel, I. Dandouras, H. Matsui, M. Dunlop, J. Cabrera, A. Masson, P. Canu, J. G. Trotignon, J. L. Rauch and M. André (2006), Analysis of plasmaspheric plumes: CLUSTER and IMAGE observations. *Annales Geophysicae*, 24(6), 1737-1758, doi:10.5194/angeo-24-1737-2006.

Lemaire, J. F. (2000), The formation of plasmaspheric tails, *Physics and Chemistry of the Earth, Part C: Solar, Terrestrial & Planetary Science*, 25(1-2), 9-17, doi:10.1016/S1464-1917(99)00026-4.

Lemaire, J. and K. I. Gringauz (1998), *The Earth's Plasmasphere*, Cambridge University Press, Cambridge, U.K.

Lemaire, J. F. and V. Pierrard (2008), Comparison between two theoretical mechanisms for the formation of the plasmopause and relevant observations, *Geomagnetism and Aeronomy*, 48(5), 553-570, doi:10.1134/S0016793208050010.

Lemaire, J. and R. W. Schunk (1992), Plasmaspheric wind, *Journal of Atmospheric and Terrestrial Physics* 54(3-4), 467-477, doi:10.1016/0021-9169(92)90026-H.

Pierrard, V., G. V. Khazanov, J. Cabrera and J. Lemaire (2008), Influence of the convection electric field models on predicted plasmopause positions during magnetic storms, *Journal of Geophysical Research: Space Physics*, 113(A8), A08212, doi:10.1029/2007JA012612.

Pierrard, V. and K. Stegen (2008), A three-dimensional dynamic kinetic model of the plasmasphere, *Journal of Geophysical Research: Space Physics*, 113(A10), A10209, doi:10.1029/2008JA013060.

Websites

Plasmasphere Simulations:
<http://plasmasphere.aeronomie.be>

AWDA Network (Automatic Whistler Detector and Analyzer):
<http://awda.aeronomie.be>

European Space Weather Portal:
<http://www.spaceweather.eu>

NASA Community Coordinated Modeling Center:
<http://ccmc.gsfc.nasa.gov>

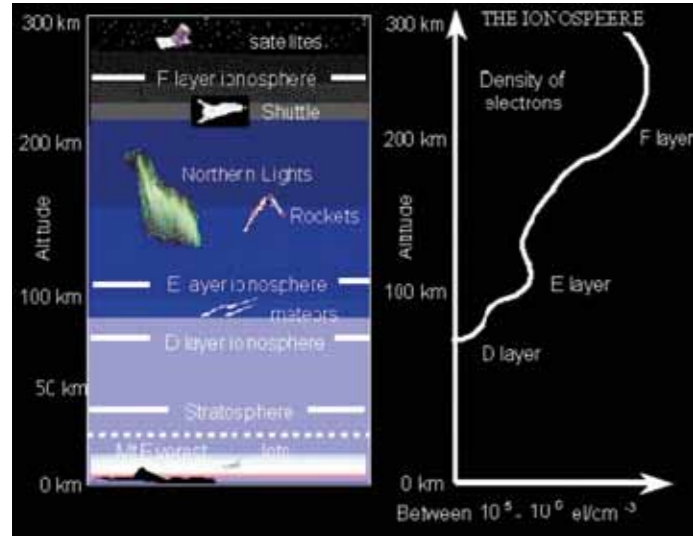

Typical daytime profile of the electron density with altitude. The left hand panel shows the location of the layers of the ionosphere in altitude. The right hand panel shows the peaks in the electron concentration that are referred to as the D, E and F layers of the ionosphere. The alphabetic nomenclature was introduced by Appleton who used the letters E and F letters for Electric and Field.

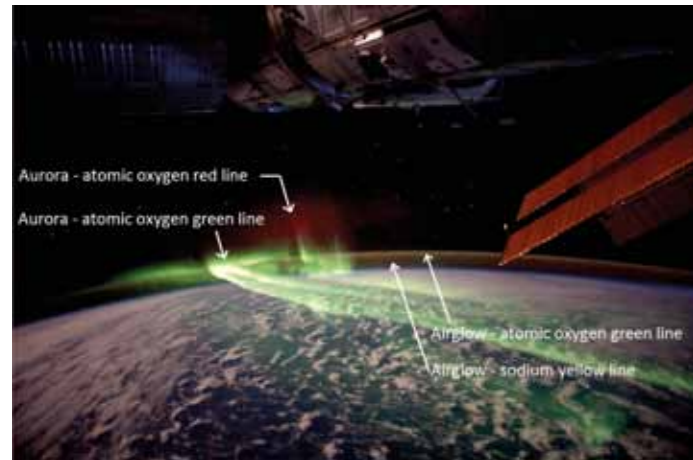

Picture of auroral emission and of airglow as seen from the International Space Station. (credit: ESA/NASA)

THE IONOSPHERE AND ITS COUPLING TO THE MAGNETOSPHERE

Johan De Keyser and Michel Roth

In 1901 Marconi established the first trans-Atlantic radio link between Poldhu in Cornwall and Newfoundland. The success of this transmission led Kennelly and Heaviside to propose the existence of an electrically conducting layer in the upper atmosphere (1902). They suggested that, because of the Earth's curvature, the radio waves involved in Marconi's experiments could not have travelled directly across the Atlantic but must have been reflected from this conducting layer. The upper atmosphere therefore had to be partially ionized. The neutral part of the upper atmosphere is called the thermosphere, while the ionized part is referred to as the ionosphere.

Although electrified layers within the upper atmosphere had already been suggested by Steward in 1878 and Schuster in 1889, the physical study of the ionosphere, strongly stimulated by the development of broadcasting, really started with radio wave experiments. In 1925 the ionosonde technology was invented by Breit and Tuve. Two years later, Appleton came up with a complete theory of the propagation of electromagnetic waves in a medium composed of charged and neutral particles, subject to the effect of collisions and in the presence of a magnetic field. The ionogram was first introduced into ionospheric research in 1933 as a way of producing as much information as possible about the ionosphere on a single graphic record taken from the ground by ionosondes. It is constructed by bouncing pulses of radio waves with frequencies from 1 to 30 MHz off the ionized regions of the atmosphere. From the frequency and time delay (or virtual height) of the reflected waves, the ionosphere was found to consist of two main layers, or peaks in the electron density with altitude. They became known as the E and F layers. This nomenclature is still in use today. The D layer was discovered later at lower altitude.

It is important to notice that at the altitude where the highest electron density occurs (10^6 cm^{-3} at 250 km) about one in every 1,000 air particles is ionized. In general, the atmosphere is progressively more ionized with altitude, but it also becomes less dense. Above roughly 600 km, the gas is essentially collisionless. This situation, however, is a bit idealized: ionosonde soundings reveal a broad range of density profiles in which periodic and sporadic time variations can be identified. It is worthwhile to outline that during the International Geophysical Year of 1957-58, an international cooperative effort, including Belgium, set up a worldwide network of ionosondes to record vertical sounding measurements during the 1957-59 period of maximum solar activity. At present, Belgium operates an ionosonde at the Geophysical Center of the Royal Meteorological Institute in Dourbes.

The physical and chemical processes responsible for excitation and ionization of the thermospheric particles lead to the production of airglow and auroras. Both phenomena refer to the light emitted by excited atoms or molecules (neutral or ionized) as they return to their ground states. While airglow is due to emission from excited states formed by processes resulting (directly or indirectly, e.g. through chemical reactions) from solar electromagnetic radiation, auroral excitation results from collisions with magnetospheric energetic electrons. During the period from 1937 to 1940, Nicolet made the first correct analysis of the identification of spectral lines in the aurora and airglow. With Bates, he concluded that the luminous layers of the atmosphere could not be at such great altitudes as was claimed by observers.

There are several sources of ionization in the ionosphere. First, there is photo-ionization due to absorption of energetic solar ultraviolet and X-ray radiation. The vertical stratification of the Earth's atmosphere and its composition therefore leads to the existence of the D, E, and F layers. Marcel Nicolet, founding father of the Belgian Institute for Space Aeronomy, pioneered studies of the impact of solar electromagnetic radiation on the ionosphere already before World War II. This represented one of the first steps that led to the development of aeronomy as a scientific discipline, and to the founding of the Belgian Institute of Aeronomy in November 1964. Nicolet soon realized that the structure of the ionosphere depends simultaneously on the vertical distribution of the neutral constituents (nitrogen and oxygen) and on the spectral distribution and the absorption of the solar radiation. In addition, he pointed out the importance of the chemical reactions occurring between the ions and the neutral particles and of the processes that result in the disappearance of electrons and ions. Indeed, while ionization is produced during the day, recombination processes lead to a reduction of the electron density during the night. Recombination is very rapid for the D and E layers, since the neutral density is elevated at those altitudes, so that they essentially disappear at night. At low latitudes, the ionized particles in the F layer during daytime move upwards along the (closed) geomagnetic field lines and fill the plasmasphere (see next section), only to descend again during the night time, thus helping to maintain the F-layer during the night. Much of the research done at BIRA-IASB on the solar spectrum (see chapter 3) directly pertains to this ionization source. Note also that the same photo-ionization processes operate in the atmospheres of other planets and comets.

After World War II, Marcel Nicolet became an authority in atmospheric ion chemistry after his publication of "Contribution to the Study of the Structure of the Ionosphere" in which he wrote: "In the present state of our knowledge of the constitution of the Sun and of the atmosphere and of the recent progress in atomic and molecular theory, it is possible to attempt a solution of the problem of the ionosphere in its general aspects. Thus, our work is primarily concerned with an examination of the properties of the ionosphere based on the results of observations of the propagation of electromagnetic waves, results which can be used owing to continuous and detailed publications." He provided the first explanation of the various origins of the atmospheric ionized layers in relation to

the ultraviolet solar radiation. In particular, he suggested that the Lyman- α radiation of solar chromospheric hydrogen (at 121.6 nm) led to the ionization of nitric oxide (NO), a trace constituent of the atmosphere with a rather low ionization potential. This work brought him international tribute. In 1951 he received an invitation from Art Waynick, head of the Department of Electrical Engineering of the Pennsylvania State University, to be research professor at the Ionospheric Research Laboratory. The origin of the ionospheric D region was explained by Nicolet in 1960 in a classic paper where the hypothesis of the Lyman- α solar radiation as an important ionizing source was reinforced. Up to 70 km, cosmic rays and hard solar X-rays (< 1 nm) are the most ionizing agents acting on molecular oxygen and nitrogen (the major neutral constituents). In the 70-85 km region and during quiet time solar conditions, the Lyman- α solar radiation ionizes nitric oxide. Lyman- α radiation penetrates in this region because it cannot ionize any gases found at higher altitudes nor be strongly absorbed by them. The ionization between 85 and 100 km altitude (base of the E region) is different. It is the result of solar X-rays (31-100 nm) ionizing molecular oxygen and nitrogen, of the Lyman- α of solar hydrogen (at 102.6 nm) ionizing molecular oxygen, and of the Lyman continuum ionizing atomic and molecular oxygen. In 1980, work at the Institute on upper atmosphere ionization was performed by Gaston Kockarts and Jacques Wisenberg with studies on negative ions and on charged particle fluctuations. The emphasis, however, progressively shifted more towards the chemistry in the lower atmosphere.

A second source of ionization is bombardment of the atmosphere with particles from the magnetosphere or from farther away. The best known example of this occurs in the auroral ionosphere, where accelerated electrons and/or ions originating in the magnetosphere are accelerated downwards and collide with the neutral thermosphere particles so as to produce a lot of spatially localized ionization. Depending on their energy spectra, auroral precipitating electrons deposit their energy at different altitudes where the resulting excited atoms and molecules originate from a changing atmospheric composition. This explains the different colours of aurora, but also identifies the source and altitude of the emitted light. Atomic oxygen (O) produces the typical greenish colour of many aurora, whose spectral signature is a line at 557.7 nm. This line is the most intense at an altitude of 120 km. Above 250 km, atomic oxygen produces another intense line at 630 nm, typical of the reddish aurora at high altitudes. Below 90 km, molecular nitrogen (N_2) is responsible of the blue lines at 391.4 and 427.8 nm. Many other emissions also occur outside the visible wavelengths. The excited states of the oxygen atom in an aurora are meta-stable states that have lifetimes in the range of milliseconds to seconds (compared to about 1 nanosecond for the lifetime of ordinary excited states). Corresponding auroral transitions are only possible in the near vacuum of the upper atmosphere where collisions are less frequent. They are called "forbidden" transitions because in ordinary conditions (like in the laboratory), the excited atoms would not have emitted light as they would have lost their energy in the form of heat by collisions with other atoms and molecules. It should be noted that, while the accelerated auroral electrons and/or ions produce a lot of ionization, the associated heating may promote ionospheric outflows. Additional

particle bombardment occurs in the cusps, where solar wind particles may reach down into the ionosphere. Above the polar cap, there is the polar rain: fast solar wind electrons that follow the half-open magnetic field lines through the lobes and ultimately reach the upper atmosphere. At the same time the polar wind removes ions and electrons from the ionosphere. Occasionally, solar energetic particles produced intermittently as a consequence of solar activity may hit the atmosphere. And finally, there is the more permanent cosmic ray bombardment of the atmosphere; because of their high energies, these particles contribute in particular to ionization at lower altitudes.

A third type of ionization source is the high-speed entry of meteoroids into the atmosphere. The ionization trails of meteors are examined at BIRA-IASB with the BRAMS radio meteor network (see section "BRAMS", chapter 10). This ionization source is very intermittent and it changes in the course of the day and with the season. It is also spatially anisotropic.

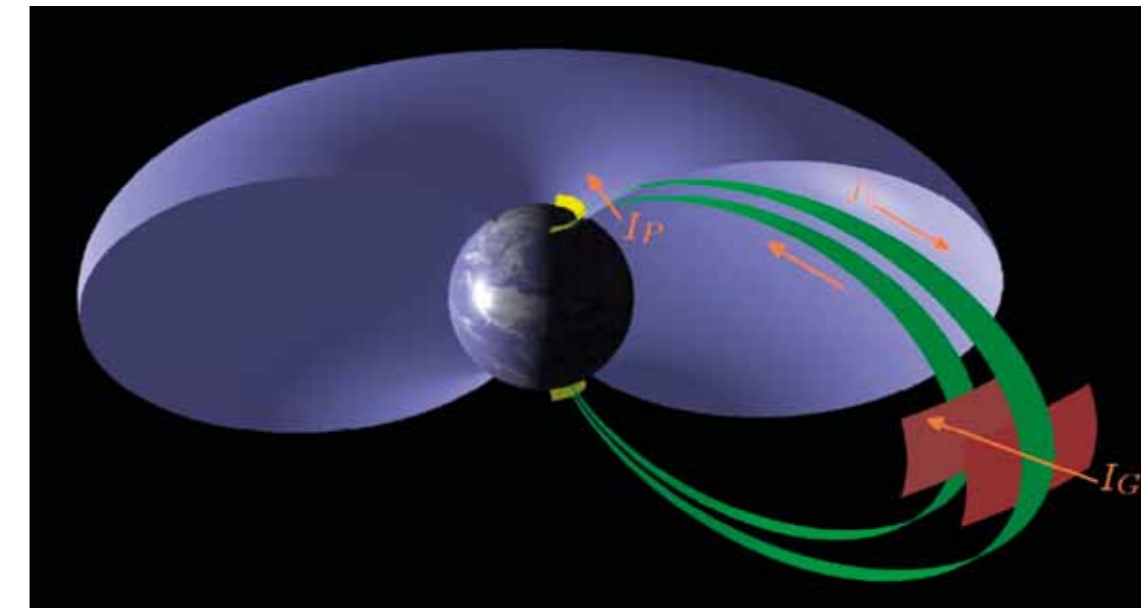

The auroral current circuit: an electric potential difference in the magnetosphere acts as a source that drives a current I_G ; this current flows downward along the magnetic field lines as a Birkeland current j_{\parallel} , runs as a horizontal Pedersen current I_P through the ionosphere, and flows as an upward Birkeland current back to the source. (from De Keyser and Echim, 2010)

Much of BIRA-IASB's research regarding the ionosphere focuses on the electrodynamic coupling between the magnetosphere and the ionosphere. The underlying reason is that one can only understand the magnetosphere if one accounts for the role of the ionosphere. There are basically two aspects to consider: Ionospheric outflows are a source of plasma for the magnetosphere (in particular of O^+ , which is much heavier than H^+ and has an effect on some dynamic processes) and affect its composition. And, also, the electric conductivity of the ionosphere plays a crucial role in the auroral electric circuit. This electric conductivity is directly related to the number of free charge carriers in the ionosphere, that is, the degree of ionization. Several aspects of the quasi-static auroral electric circuit have been examined by Johan De Keyser, Marius Echim, and Romain Maggiolo in recent years, both from the theoretical and the observational point of view. The auroral circuit is typically driven by a magnetospheric structure that behaves as a current source or as an electric potential source, depending on the circumstances. Various types of such generator structures have been considered. The source drives a current that flows downward as a field-aligned current or Birkeland current to the ionosphere, since magnetic field lines can be considered to be rather good electric conductors as charged particles typically just follow them as in an electrically conducting wire. The current then runs as a horizontal current (known as the Pedersen current) through the ionosphere, and flows as an upward field-aligned current back to the source. The ionosphere acts as a closure path for the current, allowing the magnetospheric potential difference to discharge through the ionosphere. In doing so, energy is delivered from the magnetosphere to the auroral ionosphere. This description provides a clear explanation as to how magnetospheric electric potential differences across magnetic field lines are transformed into electric potential differences along magnetic field lines. This then may lead to electrostatic auroral acceleration of magnetospheric particles down into the ionosphere, and of ionospheric material up into the magnetosphere, i.e., ionospheric outflow. Interestingly, the same mechanism can be invoked for a host of auroral phenomena, such as diffuse aurora, discrete aurora, black aurora, polar cap arcs, and subauroral ion drift that have been studied by BIRA-IASB's Space Physics Division.

Observational studies of the magnetosphere-ionosphere coupling have mostly relied on Cluster and other spacecraft (see section “Cluster”, chapter 8). In recent years, however, we have started to work with ground-based instrumentation, such as the European Incoherent SCATter Radar (EISCAT) in Scandinavia and with the Auroral Large Imaging System (ALIS) run by the Institute For Space Physics in Kiruna, Sweden. Such ground-based observations allow a very detailed analysis of the ionospheric signatures of aurora, for instance by providing a 3-dimensional scan of the state of the ionosphere, a technique called “ionospheric tomography”. Hervé Lamy and Cyril Simon Wedlund have shown that one can obtain some of the characteristics of the precipitating electrons from such measurements. A spectrophotopolarimeter for measuring the polarization of certain auroral emission lines is being built and will soon be used in coordinated measurement campaigns in Scandinavia.

In conclusion, BIRA-IASB has worked over the years on many aspects of the ionosphere, especially its connection with the magnetosphere, often at auroral latitudes. These activities are complementary to those of the Geophysical Observatory of the Royal Meteorological Institute in Dourbes that focuses on monitoring the state of the ionosphere, in particular at mid-latitudes.

The charged particle content of the ionosphere has many practical consequences. For instance, the presence of charged ions affects the chemistry in the upper atmosphere. The auroral regions, for instance, are known to feature an enhanced NO_x abundance. The ionization also has a major effect on radio wave propagation. It is very well established that the total electron content in the ionosphere slightly decelerates the propagation speed of radio signals, thus leading to a small phase shift in GNSS (Global Navigation Satellite System) signals and producing a positioning error; a topic that is heavily studied at the Royal Observatory.

Selected References

De Keyser, J. and M. Echim (2010), Auroral and sub-auroral phenomena: An electrostatic picture, *Annales Geophysicae*, 28(2), 633-650, doi:10.5194/angeo-28-633-2010.

Echim, M. M., R. Maggiolo, M. Roth and J. De Keyser (2009), A magnetospheric generator driving ion and electron acceleration and electric currents in a discrete auroral arc observed by Cluster and DMSR, *Geophysical Research Letters*, 36(12), L12111, doi:10.1029/2009GL038343.

Maggiolo, R., M. Echim, J. De Keyser, D. Fontaine, C. Jacquey and I. Dandouras. Polar cap ion beams during periods of northward IMF: Cluster statistical results, *Annales Geophysicae*, 29(5), 771-787, doi:10.5194/angeo-29-771-2011.

Nicolet, M. (1945), Contribution à l'étude de la structure de l'ionosphère, Thesis, Faculté des Sciences, Université Libre de Bruxelles, Brussels.

Simon Wedlund, C., H. Lamy, B. Gustavsson, T. Sergienko and U. Brändström (2013), Estimating energy spectra of electron precipitation above auroral arcs from ground-based observations with radar and optics, *Journal of Geophysical Research: Space Physics*, 118(6), 3672-3691, doi:10.1002/jgra.50347.

Wisemberg, J. and G. Kockarts (1980), Negative ion chemistry in the terrestrial D region and signal flow graph theory, *Journal of Geophysical Research: Space Physics*, 85(A), 4642-4652, doi:10.1029/JA085iA09p04642.

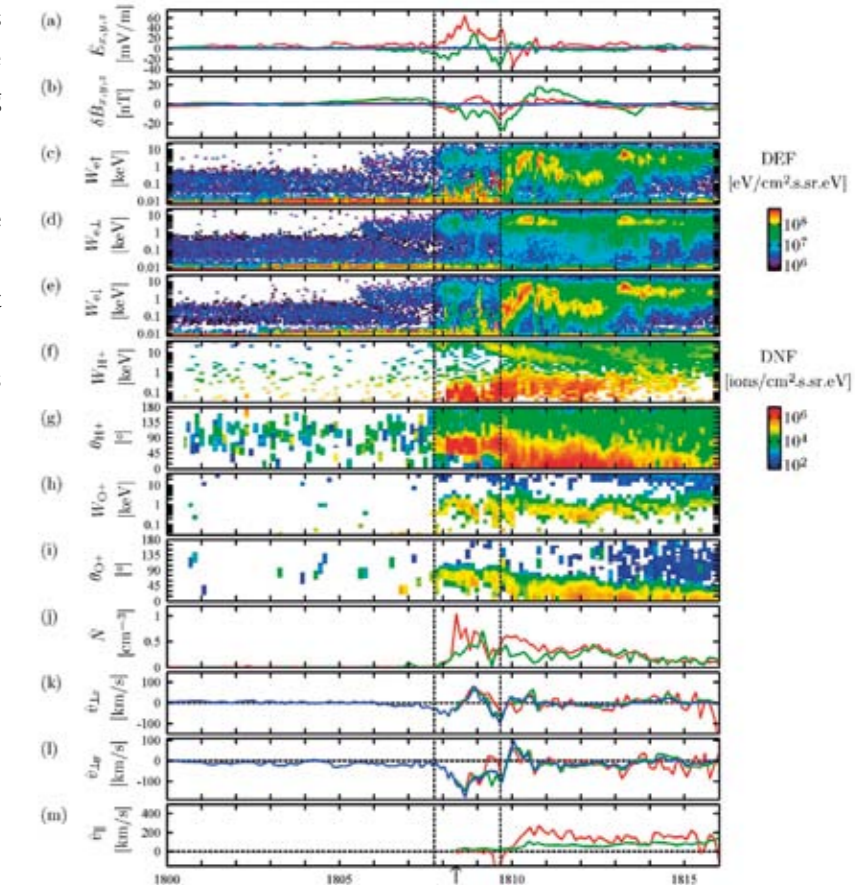

Observations by the Cluster 1 spacecraft flying above an auroral arc sheet on 28 February 2003, 18:00-18:16 UT, at 30 000 km altitude and -73.5° invariant latitude. The data are shown in a stationary frame with x along the interface normal and z along the magnetic field. The vertical lines identify the region of upward current. This current is carried by electrons being accelerated downward into the ionosphere (higher fluxes in panel c). At the same time, the electric potential accelerates ions (H^+ and O^+) upwards. (panels f and h give the energy spectra, g and i give the pitch angle spectra) (adapted from De Keyser et al., 2011)

ENERGETIC PARTICLES IN SPACE

Norma Crosby

Apart from the typical plasma particles that constitute the bulk of the solar wind or the magnetospheric environment, there always exists a minority contribution of highly energetic particles, mostly electrons, protons, alpha particles. BIRA-IASB has specifically studied such high-energy particles because of their potential space weather effects: such particles constitute ionizing radiation and as such they form a hazard for both robotic and manned spaceflight (see section “Space weather”, chapter 14). There are three major categories of energetic particles: solar energetic particles, galactic cosmic rays, and particles in the Earth’s radiation belts.

Solar energetic particles occur in “events” of limited duration (hours to days). In general such events result from the acceleration of particles either by solar flares, by interplanetary shocks driven by coronal mass ejections or by shocks associated with corotating interaction regions. They typically consist of electrons, protons, and heavier ions up to iron, with energies from dozens of keVs to a few GeVs. By studying these events, one can obtain information on the physical mechanisms of particle acceleration, as well as on the eruption site conditions, and on the properties of the space environment sampled by these particles during their trip to the observer. Our understanding of the mechanisms associated with the generation, acceleration, and propagation of solar energetic particles is far from complete due to its inherent three-dimensional nature, the lack of spatially distributed in situ observations, and the complex nature of the underlying physical processes. The accurate modelling of the solar energetic particle environment constitutes a priority requirement for interplanetary robotic missions and human space exploration as these particles pose a health risk to humans and a serious radiation hazard for spacecraft. Protons are the predominant ion species in large events and constitute the primary radiation hazard, causing both short-term single event effects and long-term total radiation dose effects.

The Institute has been involved in the ESA project “Solar Energetic Particle Environment Modelling” (SEPEM) for developing tools to study solar energetic particle events. BIRA-IASB was prime contractor for an international consortium that worked on this project. The SEPEM application server, hosted and maintained at BIRA-IASB, was one of the main outcomes of the project. It offers a web interface to solar energetic particle data and a range of modelling tools and functionalities intended to support space mission design. In the framework of the project, new engineering models and tools to deal with solar energetic particles have been created by incorporating recent scientific results and a complete set of cross-calibrated data. A contiguous reference proton data set was constructed using data ranging from 1973 to 2013, by means of data cleaning

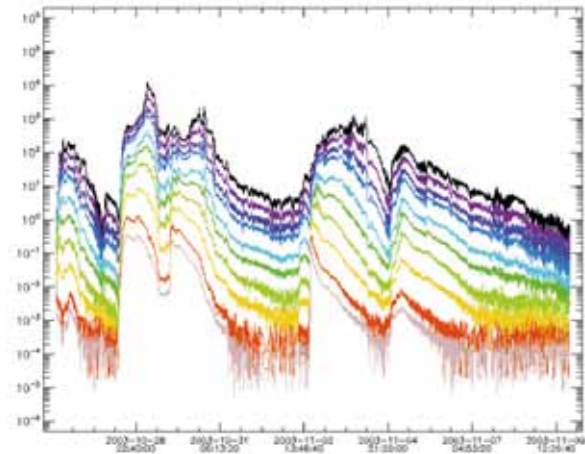

5.00–7.23 MeV H flux	7.23–10.46 MeV H flux
10.46–15.12 MeV H flux	15.12–21.37 MeV H flux
21.37–31.82 MeV H flux	31.82–45.73 MeV H flux
45.73–66.13 MeV H flux	66.13–95.64 MeV H flux
95.64–138.3 MeV H flux	138.3–200.0 MeV H flux

Proton flux profiles for the duration of the SEPEM reference proton event that began on October 26, 2003. (Generated by SEPEM)

and processing tools available on the server. Using this dataset, a reference event list was constructed and made available on the server. Both statistical and physical modelling techniques were used to study these events, which cover heliocentric distances ranging from 0.2 AU to 1.6 AU. The SEPEM event statistics moved beyond mission integrated fluence to peak flux and duration of high flux periods. Furthermore SEPEM integrated effects tools to allow calculation of single event upset rate and radiation background for a variety of engineering scenarios; statistical methods can further be applied to these effects parameters.

Building on the SEPEM expertise, an EU FP7 project COMESSEP (COronal Mass Ejections and Solar Energetic Particles: forecasting the space weather impact) was started for building tools to forecasting geomagnetic storms and solar energetic particle radiation storms (2011-2013). Norma Crosby was coordinator of this collaborative project. The tools that were developed have been implemented into an operational space weather alert system, hosted at the Institute. Geomagnetic and solar energetic particle radiation storm alerts are based on the COMESSEP definition of risk and disseminated to the space weather community. To achieve this, the system relies on both models and data, the latter including near real-time data as well as historical data. One of the important outcomes of the scientific analysis carried out by Mark Dierckxens has been to identify key ingredients that lead to solar energetic particle events. COMESSEP is a unique cross-collaboration effort and bridges the gap between the solar energetic particle community, solar coronal mass ejection monitors, and the terrestrial effects community. BIRA-IASB has focused on the quantification of solar energetic particle event occurrence probabilities and on the correlations between such events and solar phenomena.

The second category of energetic particles are the galactic cosmic rays. These are the most energetic particles (energies up to 10^{21} eV) and originate from outside the Solar System. They form a rather permanent background. During a mission to the Moon and Mars, for instance, spacecraft and crews will be exposed not only to occasional solar energetic particle events, but also to galactic cosmic rays, as well as to energetic secondary nucleons and heavier nuclear fragments generated by the interactions of these particles in the spacecraft materials. Once on the surface of Mars, the radiation risk to the astronauts can in fact increase because of the secondary radiation produced by the interactions of the galactic cosmic rays and the solar energetic particles in the atmosphere and soil.

In this context, BIRA-IASB contributed to the Alenia Spazio S.p.A. lead ESA Radiation Exposure and Mission Strategies for Interplanetary Manned Missions (REMSIM) project that ended in 2004. REMSIM concerned cosmic radiation in relation to human interplanetary missions. The study covered strategies and countermeasures to ensure the protection of astronauts from radiation during interplanetary missions, with specific reference to: radiation environment and its variability; radiation effects on the crew; transfer trajectories and associated fluences; vehicle and surface habitat concepts; passive and active shielding concepts; space weather monitoring



The ESA Aurora Programme. (credit: ESA)

and warning systems. BIRA-IASB performed the review of the precursors of solar and interplanetary phenomena at work in interplanetary space weather, including remote sensing and in-situ databases, models, as well as monitoring and warning systems. The feasibility to use and integrate existing systems was assessed taking into account radiation dose thresholds. Various integrations of models and data systems from future planned missions were considered and recommendations for warning systems were given.

More recently, BIRA-IASB contributed to the QinetiQ lead ESA Martian Radiation Environment Models (MarsREM) project. The objective was to develop physically accurate and easy-to-use models to allow scientists and engineers to predict the radiation environment for Mars orbits, within the Martian atmosphere and for sub-surface conditions, as well as for the environments on the moons Phobos and Deimos. During the MarsREM project, BIRA-IASB was responsible for reviewing galactic cosmic ray and solar energetic particle data and models of these environments, and for creating a database of radiation data and an interface to that database. To define the Martian primary particle environment “standard” energy spectra or models of galactic cosmic rays, solar energetic particles, and solar X-rays were derived by scientists at the Institute for use in radiation transport codes performed by other MarsREM team members. This work was performed in close collaboration with the Space Weather team of the Institute (see section “Space weather”, chapter 14).

The third category of energetic particles are those that have become trapped in the Earth’s geomagnetic field, thus creating the doughnut shaped radiation belts. Earth’s inner proton radiation belt consists of energetic protons extending up to energies > 50 MeV near $1.3 R_E$ (Earth radii) and is fairly stable in time. The electron radiation belt consists of electrons up to several MeV and is split into two regions: a fairly stable inner belt ($1.5 - 2.5 R_E$) and a highly dynamic outer belt ($3 - 9 R_E$). The relativistic electron flux in the outer belt can increase by up to five orders of magnitude on timescales of a few days, and in exceptional cases as short as a few minutes. Electron flux variations (spatial extent and location of peak flux) are driven by changes in the solar wind which couple through the magnetosphere and drive changes in the source of electrons, the transport mechanisms, the acceleration and loss processes. Satellites situated in Earth’s geostationary orbit are highly vulnerable to these periods of enhanced electron flux.

BIRA-IASB has worked on the modelling of the radiation belts for many years, in particular since the ESA-sponsored TRapped Radiation ENvironment Development (TREND) project that consolidated and added to earlier efforts to evaluate radiation dose and fluences expected in a spacecraft on a given orbit (see section “Space weather”, chapter 14). More recently, however, research on the radiation belts has picked up new momentum with the EPT instrument on PROBA Vegetation that is currently collecting data on the energetic particles around Earth (see “ALTIUS”, chapter 8).

Apart from observations, the Institute is also involved in modelling efforts regarding the radiation belts as part of an EU FP7 project “Space Weather Integrated Forecasting Framework”. The broad goal is to develop forecasting models for space weather phenomena from the Sun to the inner magnetosphere that are especially designed to handle the multi-physics and the multi-scale characteristics of space weather processes. BIRA-IASB is in charge of the “Coupling at the Earth” part of the Sun-Earth scenario covering the inner magnetosphere, the plasmasphere coupled to the ionosphere, the polar wind, and the Earth’s radiation belts. The dynamics of the electron radiation belts is studied using Cluster and other satellite observations with the objective to develop an empirical model able to reproduce the flux variations appearing during geomagnetic storms. The spectra of electrons and protons in the radiation belts were analysed in detail to compare with the future observations of the EPT instrument. In order to understand the dynamic behaviour of the radiation belts, their relation with the plasmasphere and the plasmopause position has been examined with Cluster.

Selected References

- Crosby, N., V. Bothmer, R. Facius, J.-M. Grießmeier, X. Moussas, M. Panasyuk, N. Romanova and P. Withers (2008), Interplanetary Space Weather and Its Planetary Connection, *Space Weather*, 6(1), S01003, doi:10.1029/2007SW000361.
- Crosby, N. B., A. Veronig, E. Robbrecht, B. Vrsnak, S. Vennerstrom, O. Malandraki, S. Dalla, L. Rodriguez, N. Srivastava, M. Hesse, D. Odstrcil and COMESEP Consortium (2012), Forecasting the space weather impact: The COMESEP project, *AIP Conference Proceedings*, 1500, 159-164, doi:10.1063/1.4768760.
- Darrouzet, F., V. Pierrard, S. Benck, G. Lointier, J. Cabrera, K. Borremans, N. Yu Ganushkina and J. De Keyser (2013), Links between the plasmopause and the radiation belt boundaries as observed by the instruments CIS, RAPID and WHISPER onboard Cluster, *Journal of Geophysical Research: Space Physics*, 118(7), 4176-4188, doi:10.1002/jgra.50239.
- Foullon, C., D. Heynderickx and N. Crosby (2005), Toward Interplanetary Space Weather: Strategies for Manned Missions to Mars, *Space Weather*, 3(7), S07004, doi:10.1029/2004SW000134.
- Jiggins, P.T.A., S. B. Gabriel, D. Heynderickx, N. Crosby, A. Glover and A. Hilgers (2012), ESA SEPEM Project: Peak Flux and Fluence Model, *IEEE Transactions on Nuclear Science*, 59(4), 1066-1077, doi:10.1109/TNS.2012.2198242.
- Truscott, P., F. Lei, N. Crosby, G. Degreef, L. Desorgher, P. Gonçalves, D. Heynderickx, A. Keating, B. Quaghebeur, S. Valente and H. de Witten (2009), Martian Radiation Environment Models (MarsREM), ESA/ESTEC Contract NO. 19770/06/NL/JD.

Websites

- The SEPEM Application Server:
<http://dev.sepem.oma.be/>
- The EU FP7 COMESEP Project:
<http://www.comesep.eu/>
- The ESA MarsREM Project:
<http://reat.space.qinetiq.com/marsrem/>

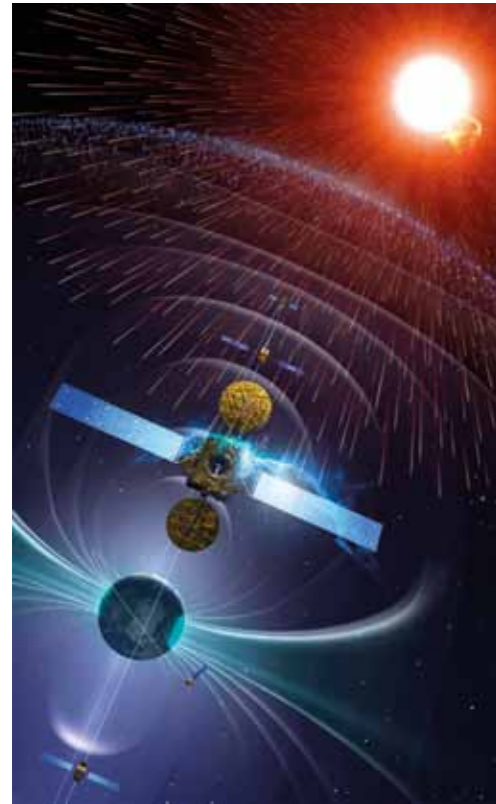

Space Situational Awareness. (credit: NASA)

5



BELEGCH INSTITUUT VOOR RUIMTE-AERONOMIE (BIRA) INSTITUUT D'AERONOMIE SPATIALE DE BELGIQUE (IASB) BELGIAN INSTITUTE FOR SPACE AERONOMY (BIRA-IASB) BELGIECH INSTITUUT VOOR RUIMTE-AERONOMIE (BIRA) INSTITUUT D'AERONOMIE SPATIALE DE BELGIQUE (IASB)

FROM THE UPPER ATMOSPHERE TO THE TROPOSPHERE: THEORIES AND MODELS

Jean-François Müller and Simon Chabrillat



The Earth's limb seen from the International Space Station in February 2010 with the silhouette of shuttle Endeavour. The orange layer is the troposphere, the whitish layer and blue layers are the stratosphere and the mesosphere. (credit : NASA)

Simon Chabrilat and Guy Brasseur (MPI-M, NCAR)

What is the structure of our atmosphere? What are the causes of this structure? What is its chemical composition and why? How does the composition vary with time and why? These are the questions at the heart of theoretical aeronomy. As in other fields of physical science, this theory is expressed through models, i.e. simplified representations of our knowledge. Theoretical models can be analytic (expressed through mathematical equations) or numerical (programmed into computer code and run to deliver numeric output).

The vertical structure of the atmosphere is most commonly described by the variation of temperature as a function of height, determining five primary atmospheric regions: the troposphere, the stratosphere, the mesosphere, the thermosphere and the exosphere. This structure was proposed by Sydney Chapman in 1950, with help from David Bates and Marcel Nicolet. Ascending rockets and balloons first go through the troposphere, where the temperature decreases with increasing height: this is the region where most meteorological phenomena occur. Starting at approximately 15 km altitude, we encounter a region of increasing temperature: this is the stratosphere, heated mainly by the absorption of the ultraviolet sunlight by ozone. Balloons and planes cannot reach higher regions, leaving *in situ* exploration to sounding rockets: at approximately 50 km altitude, these enter into the mesosphere, where the temperature decreases as the rocket goes up. At approximately 90 km, the temperature starts increasing again: our rockets enter the thermosphere, where the air density is low enough to allow artificial satellites to circle the Earth. Hence the thermosphere is often considered as the "edge of space": the *Fédération Aéronautique Internationale* acknowledges as "spaceflight" any trip in the atmosphere exceeding an altitude of 100 km.

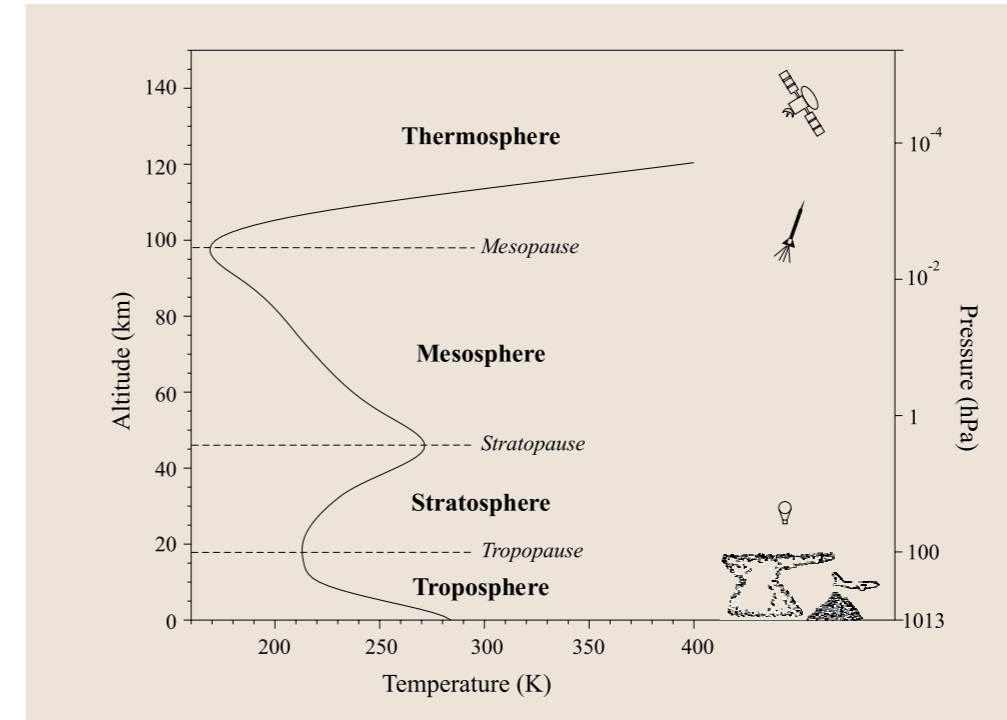

The primary atmospheric regions of Earth from the vertical distribution of temperature (Globally and annually averaged output of model MSIS).

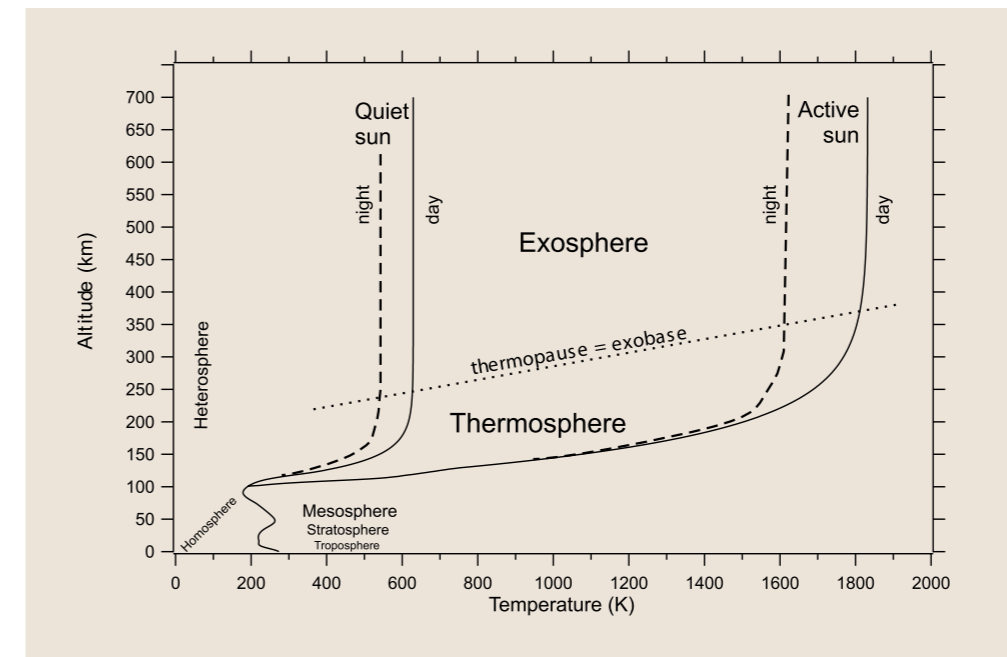

Vertical distribution of temperature from the surface up to 700 km altitude, showing the upper atmospheric regions and the impacts of diurnal cycle and solar activity.

On their upward trip, human observers of course left for a long time the atmospheric region that is hospitable to life, i.e. the lower half of the troposphere. They cannot breathe above this shallow layer, and require an artificially pressurized environment even before entering into the stratosphere. The upper stratosphere and mesosphere already exhibit the visual clues of the spatial environment, i.e. daytime blackness and a visibly round horizon. The thermosphere, on the other hand, is still a region of the terrestrial atmosphere, because it is composed of atoms and molecules which are still gravitationally bound to the planet. Hence the mesosphere and thermosphere can be considered both as atmospheric regions and as the first outposts of the spatial environment.

Strictly speaking, the terrestrial atmosphere does not even end with the thermosphere. At heights between 500 and 1000 km, depending on solar activity, the density becomes so low that the atoms and molecules can travel hundreds of kilometers without colliding with one another. Even though some neutral particles escape into interplanetary space, most are still gravitationally bound to the Earth, hence we may still consider that this region is an atmospheric layer. This layer is the exosphere, where the temperature remains approximately constant with respect to altitude. Here the usual laws of thermodynamics do not apply anymore: the temperature must be considered through the kinetic theory of gases, which is based on the probability distribution of the energy of motion of gas particles. The boundary between the exosphere and truly interplanetary space is somewhere between 50 000 km (i.e. close to the geostationary orbit) and 200 000 km (i.e. halfway to the orbit of the Moon).

The vertical structure of the atmosphere can also be described by its chemical composition, determining three main atmospheric regions: the homosphere and the heterosphere for the neutral constituents (i.e. atoms and molecules) and the ionosphere for the electrically charged ions. In the homosphere, which extends from the surface up to approximately 100 km, the composition in terms of major constituents is uniform: the mixing ratios of the most abundant gases are constant, comprising mainly molecular nitrogen (N_2 , 78% per unit volume) and molecular oxygen (O_2 , 21%) while the abundance of minor constituents, such as ozone, is much smaller and very variable. Above the homosphere lies the heterosphere, where the mixing ratios of the major constituents depend on their molecular mass: their abundance decreases with height for the heavier species (Ar , O_2) and increases for the lighter species (H , He , O).

The ionosphere, finally, is a shell of electrons and electrically charged atoms and molecules that surrounds the Earth. It overlaps the upper mesosphere, the thermosphere and the lower exosphere and owes its existence

primarily to solar radiation in the extreme ultraviolet range. This solar radiation is sufficiently energetic to strip some atoms and molecules from their outermost electrons, and the air density is low enough that free electrons can exist for short periods of time before they are captured by a nearby positive ion. Hence this region of the atmosphere contains a plasma and is ionized. It must also be noted that the number of free electrons is sufficient to affect radio propagation, which allowed the discovery and characterization of the ionosphere several decades before its exploration by sounding rockets.

Let us now explore in some more detail the current theories and models explaining the structure and composition of the neutral atmosphere, and the contribution of BIRA-IASB to this field. We will travel back down to the surface, discussing first the environment of satellites, i.e. the regions above 120 km (exosphere, heterosphere, upper thermosphere). These were first explored with the advent of the Space Age, and the newly founded BIRA-IASB contributed decisively to this research. We will then review the transition regions from 120 km down to 60 km (lower thermosphere to mesosphere, heterosphere to homosphere) which are very difficult to explore *in situ* and have been a focus of aeronomic research for the last 25 years. This exploration will continue into the stratosphere which drew much attention during the 1980s and 1990s due to the impact of human activities on the ozone layer, and will end with tropospheric chemistry which has become a very important field of research due to current concerns related to air quality and climate change.

Picture of the atmosphere taken from the International Space Station showing the Polar mesospheric clouds—also known as noctilucent or “night shining” clouds—form between 76 to 85 kilometers above the Earth’s surface, near the boundary of the mesosphere and thermosphere, a region known as the mesopause. (credit: NASA)



THE UPPER ATMOSPHERE: THE REALM OF SATELLITES

Simon Chabrilat, Guy Brasseur (MPI-M, NCAR) and Paul C. Simon

Sydney Chapman and Edward Milne had shown as early as 1920 that above some layer of perfect mixing (now named the homosphere), molecular diffusion would separate the atmospheric constituents according to their mass. But the transition from homosphere to heterosphere was arbitrarily set at 20 km altitude. The correct location of the heterosphere was discovered just after the Second World War, thanks to soundings by the V-2 rocket: a decreased abundance of the noble gas argon was observed above 110 km and readily explained by molecular diffusion (Ar has a molar mass of 40 g/mole while air has an average molar mass of 28.95 g/mole in the homosphere). Hence it became clear that molecular diffusion overcomes turbulent mixing above 110 km altitude.

Until 1957 the only means to derive air density in the thermosphere was through rocket soundings. When the first artificial satellites were launched, they stayed a shorter time in orbit than anticipated from the early evaluations of air density: these appeared seriously underestimated. Indeed a satellite's orbit contracts under the action of air drag, which is directly determined by the density of air particles. In 1958, Nicolet explained that this high air density in the thermosphere was due to heat conduction (as first suggested by Sydney Chapman two years earlier) and to molecular diffusion.

Due to their low masses and local sources by photodissociation of solar light, atomic oxygen and hydrogen were known to dominate the composition of the thermosphere and the exosphere. Echo 1, a metalized balloon satellite acting as a passive reflector of microwave signals, had a large (30 m) spherical shape which allowed precise and recurring measurements of the molecular density in the exosphere. Nicolet (1961) showed that neither atomic oxygen nor atomic hydrogen could fully explain its orbital variations: they required an intermediate layer where helium is the dominant species. Later, Kockarts and Nicolet proceeded to deliver the first theoretical computations of the vertical distribution of helium. This discovery of a "helium belt" was one of the great scientific successes which led to the foundation of BIRA-IASB. The research on this theme continued at BIRA-IASB, e.g. with a kinetic model for the escape of helium and hydrogen from the atmospheres of Earth and Mars.

The air density derived from satellite drag provides measurements not only of molecular mass, but also of temperature. It was found that the temperature in the exosphere does not vary with altitude, keeping the values reached at the top of the thermosphere. These thermopause temperatures range from approximately

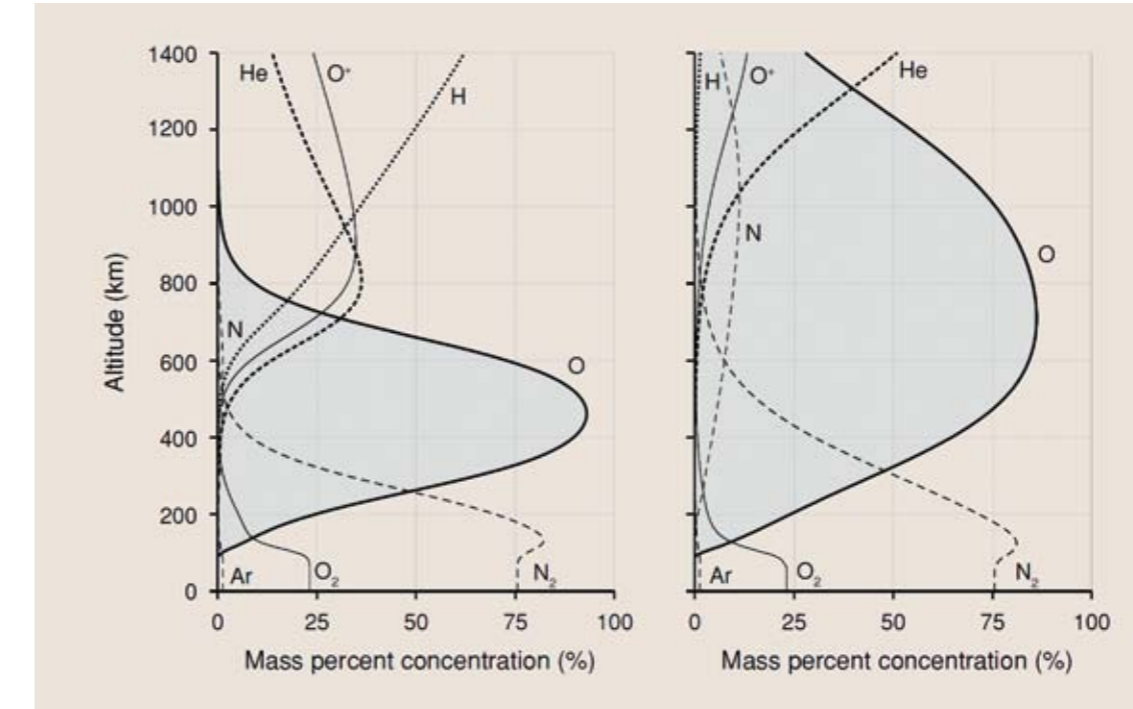

Altitude profiles of mass percent concentrations for low (left) and high (right) solar activity levels, according to the NRLMSISE-00 model, evaluated over Delft, at 18:00 on July 15, 2006 (left) and 2006 (right). From Doornbos (2012).

600 K to 2000 K depending primarily on the level of solar activity, and secondarily on the diurnal and seasonal cycles. These variations are due to the varying amounts of solar radiation absorbed in the solar X-ray and extreme ultraviolet (XUV) range.

The thermospheric temperatures, on the other hand, vary with altitude: this variation can be described through the "Bates profile" which is derived from a simple equation of heat conduction. This approximation represents well the observed continuous decrease in temperature, from the thermopause down to some level chosen in the lower thermosphere - usually 120 km.

The re-entry of a satellite is sometimes a source of anxiety as was the case, in 1979, for Skylab 1 (77 tons). The need to quickly predict the impact of atmospheric drag on the orbit of satellites, and their time before re-entry, led to the development of semi-empirical models of the thermosphere. These models combine

Aeronomy (1973) - a reference book still used 40 years later

Starting in the 1960s and until his retirement in 2002 from the lead of the “Physical Aeronomy” division of BIRA-IASB, Gaston Kockarts performed exhaustive studies of the theory of aeronomy in the upper atmosphere. Together with Peter Banks, now dean at the University of Michigan, he wrote a two-volume textbook simply titled “Aeronomy” (Banks and Kockarts, 1973) which was reviewed in the prestigious journal *Science* as

“...neither a collection of empirical facts and observations nor a historical survey of the field, but rather an attempt to develop a mathematical description of the physical and chemical processes responsible for observed atmospheric behavior. (...) This book is the most ambitious and comprehensive work on aeronomy to date and it will probably be inequaled for some years” (Rees, 1974).

Indeed, thanks to its wide scope and focus on theory, this book is still used as a reference to advance aeronomic research. Its complete explanation of molecular and thermal diffusion allows for example the evaluation of the escape rates of light elements from the atmosphere of newly discovered exoplanets – hence their probable composition (Hu et al., 2012).

Rees, M. H. (1974), Planetary Atmospheres [Review of the book *Aeronomy* by P.M. Banks and G. Kockarts], *Science*, 186, 1200.

basic physics (i.e. heat conduction and molecular diffusion) with tabulated or parameterized values of the temperature and densities at 120 km and at the thermopause. On the basis of these climatological datasets of past observations, they provide the temperature and densities of major atmospheric constituents as a function of space, time of year and level of solar activity.

Three main families of these empirical models have been developed during the last 50 years: Jacchia's, DTM and MSIS. Profiles shown in the previous figures are results by MSIS, which was extended down to the surface on the basis of climatological temperature datasets. It is a practical tool to quickly provide the basic quantities of the atmospheric environment over its whole vertical range. A more sophisticated alternative is the development of a comprehensive, first-principles, non-linear representation of the thermosphere. These models, such as TIE-GCM developed at the National Center for Atmospheric Research in the U.S., integrate in time the three-dimensional momentum, energy and continuity equations for the main species of the thermosphere.

Selected References

Banks, P.M. and G. Kockarts (1973), *Aeronomy: part A-B*, Academic Press, New York.

Doornbos, E. (2012), *Thermospheric Density and Wind Determination from Satellite Dynamics*, Springer, Berlin.

Hu, R., S. Seager and W. Bains (2012), Photochemistry in Terrestrial Exoplanet Atmospheres. I. Photochemistry Model and Benchmark Cases, *Astrophysical Journal*, 761(2), 166, doi:10.1088/0004-637X/761/2/166.

Kockarts, G. (2002), Aeronomy, a 20th Century emergent science: the role of solar Lyman series, *Annales Geophysicae*, 20(5), 585-598, doi:10.5194/angeo-20-585-2002.

Kockarts, G. and M. Nicolet (1962), Le problème aéronomique de l'hélium et de l'hydrogène neutres, *Annales de Géophysique*, 18, 269-290.

Kockarts, G. and M. Nicolet (1963), L'hélium et l'hydrogène atomique au cours d'un minimum d'activité solaire, *Annales de Géophysique*, 19, 370-385.

Nicolet, M. (1958), High Atmosphere Densities, *Science*, 127, 1317-1320, doi:10.1126/science.127.3310.1317.

Nicolet, M. (1961), Helium, an important constituent in the lower exosphere, *Journal of Geophysical Research*, 66(7), 2263-2264, doi:10.1029/JZ066i007p02263.

Pierrard, V. (2003), Evaporation of hydrogen and helium atoms from the atmospheres of Earth and Mars, *Planetary Space Science*, 51(4), 319-327, doi:10.1016/S0032-0633(03)00014-X.

Rees, M. H. (1974), Planetary Atmospheres [Review of the book *Aeronomy* by Banks, P.M. and G. Kockarts], *Science*, 186, 1200.

THE MESOSPHERE AND LOWER THERMOSPHERE: TRANSITION REGIONS AND CURRENT RESEARCH

Simon Chabrilat and Guy Brasseur (MPI-M, NCAR)

The thermosphere and stratosphere have positive gradients of temperature due to the absorption of solar UV radiation: by molecular oxygen in the thermosphere, and by ozone in the stratosphere. The mesosphere is the intermediate layer (greek “meso” meaning “middle”) where the temperature decreases with height. This is due to the absence of significant heat sources and to radiative cooling by carbon dioxide: at these low densities, the greenhouse gas emits infrared radiation rather than absorbing it, thus cooling the mesosphere.

We have seen (section “Solar wind”) that as early as 1945, Marcel Nicolet correctly hypothesized that the existence of the ionospheric D region was due to the photo-ionization of NO into NO⁺ by the solar Lyman- α line (121.6 nm). Bates and Nicolet (1950) made a second fundamental contribution to the knowledge of the mesosphere: they suggested that reactions involving hydrogen compounds (HO_x) would induce a significant catalytic mesospheric ozone loss. This first proposal of a catalytic cycle for the loss of ozone was actually based on a one-dimensional “numerical” model of mesospheric photochemistry at daytime equilibrium; it was solved through successive iterations, most probably using an electromechanic computer and tabulated functions. Its main conclusions were correct despite a grievous lack of reliable kinetic data: the photodissociation of water vapour is an important source of atomic hydrogen, and the Chapman mechanism is not sufficient to explain the abundance of ozone in the atmosphere.

Numerical models of the atmospheric composition evolved from this primitive one-dimensional layout initiated by M. Nicolet in 1950. During the 1960s, Gaston Kockarts developed one-dimensional models which did not assume equilibrium and ran on the electronic computers of the newly founded BIRA-IASB (among the first such computers in Belgium). During the 1970s and 1980s, Guy Brasseur developed a very successful two-dimensional model which integrated in time not only the chemical composition, but also the wind fields and the temperature. During the 1990s, the development of this model was transferred to the National Center for Atmospheric Research (NCAR) where G. Brasseur led its upward extension (from 85 km to 120 km altitude) and named it SOCRATES. This development still involved BIRA-IASB thanks to the tutelage of a PhD student.

For the last 15 years, NCAR pioneered the development of three-dimensional models of atmospheric chemistry extending over several atmospheric regions: MOZART, which included only chemistry and transport, was followed by WACCM (the Whole Atmosphere Chemistry-Climate Model). WACCM is now the atmospheric component of CESM (the Community Earth System Model) which also includes a land-surface, an ocean and a sea ice component. CESM is one of the leading models to study climate change at the global scale.

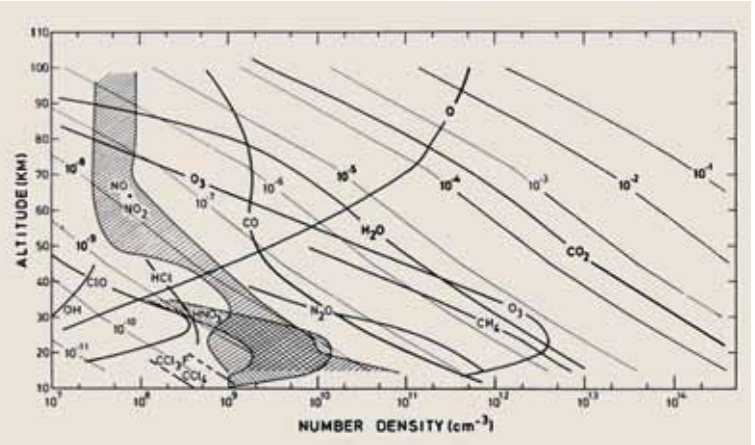

General view of the abundance of minor constituents in the stratosphere, mesosphere and low thermosphere. (after Marcel Ackerman)

At BIRA-IASB the modelling efforts for the middle atmosphere were renewed with the development of a 3D model to assimilate satellite measurements of stratospheric composition. Since the simplified photochemistry in this model did not allow simulations longer than a few weeks, the corresponding components were imported from SOCRATES and the improved Chemistry-Transport Model and associated Data Assimilation System was named BASCOE. While very successful for data assimilation applications (see Chapter 14), BASCOE does not solve the atmospheric dynamics and must be driven by wind fields computed by meteorological centers.

While it is now abandoned in favor of BASCOE, SOCRATES allowed new studies of the coupling between dynamics, chemistry and radiation in the mesosphere. This is indeed a quite turbulent region which is set in motion by nonlinear wave dynamics. At or close to the surface, the displacement of winds over orography or frontal weather patterns generates vertical oscillations of the air masses which propagate upwards: these are named inertial-gravity waves. Much like sea swell approaching the shore, the amplitude of these gravity waves increases quickly with height in order to conserve their kinetic energy in a continuously less dense medium. Some waves dissipate in the stratosphere when they encounter unfavourable winds (“critical levels”); the remaining ones break in the mesosphere, where the density is too low to allow further propagation - much like sea waves encountering the shore. And in the same manner as sand pebbles are mixed by breaking sea waves, breaking gravity waves contribute to eddy diffusion, i.e. the mixing of the atmosphere through the small-scale turbulence.

These dynamical processes are difficult to observe because in situ measurements are accessible only through occasional rocket soundings. They are yet very important to determine the location of the homopause, which separates the homosphere (where diffusion is important enough to distribute homogeneously the major atmospheric constituents) from the heterosphere (where molecular diffusion separates these constituents depending on their mass). Hence molecular diffusion cannot be neglected above the homopause. The turbopause is a related, but different concept: it is the altitude where the coefficients of molecular diffusion and vertical diffusion are equal. The value of the vertical, eddy diffusion coefficient depends primarily on the parameterization chosen to estimate the breaking of gravity waves, because this process cannot be computed exactly by chemical models of the atmosphere within their current framework. Hence, the altitude of the turbopause cannot be precisely estimated. Furthermore, this altitude is not univocally defined, because the molecular diffusion coefficient is different for each chemical species.

This explains why the conventional altitude of 100 km, often presented as the approximate location of the turbopause, should be viewed only as a general indication. Many coupled models of the dynamics and the chemistry in the mesosphere/lower thermosphere (MLT) seem to neglect molecular diffusion, or to take it into account only above 90 or 100 km altitude. Using the SOCRATES bi-dimensional model of the middle

atmosphere, Chabrilat *et al.* (2002) showed that molecular diffusion has a direct impact on the vertical distribution of CO₂ down to approximately 80 km altitude, i.e. well into the mesosphere and below the turbopause altitude.

The breaking of gravity waves in the mesosphere causes not only eddy mixing but also the global circulation cell which transports air from the summer pole upwards into the upper mesosphere, meridionally to the winter pole, and downward into the winter pole. Hence the mesospheric polar night region experiences a downdraft of air which is depleted in CO₂ due to molecular diffusion, and less radiatively cooled than if this process was neglected. Chabrilat *et al.* (2002) showed that neglecting the molecular diffusion of CO₂ leads to a polar night mesopause 12 K too cold and concluded that all models of the mesosphere should take molecular diffusion into account. Despite the excellent results obtained most recently by the 3D model WACCM against satellite measurements of CO and CO₂, it appears that even today some other atmospheric models erroneously neglect molecular diffusion while attempting to explain the atmospheric composition into or close to the heterosphere.

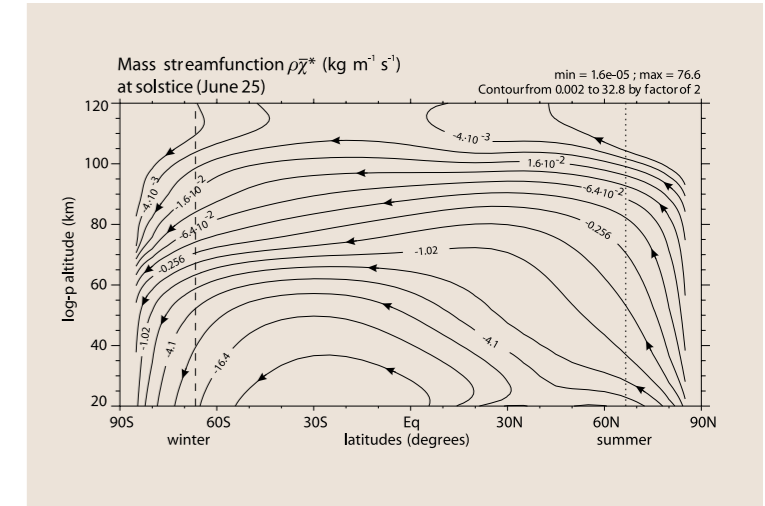

Streamlines of the residual wind field at solstice (June 25) as a function of latitude and height, computed by the model SOCRATES. The arrows show the flow from the summer to the winter pole, and the flow is faster where the lines converge.

Selected References

- Bates, D. R. and M. Nicolet (1950), The photochemistry of atmospheric water vapor, *Journal of Geophysical Research*, 55(3), 301-327, doi:10.1029/JZ055i003p00301.
- Chabrilat, S., G. Kockarts, D. Fonteyn and G. Brasseur (2002), Impact of molecular diffusion on the CO₂ distribution and the temperature in the mesosphere, *Geophysical Research Letters*, 29(15), 19-1-19-4, doi:10.1029/2002GL015309.
- Daerden, F., N. Larsen, S. Chabrilat, Q. Errera, S. Bonjean, D. Fonteyn, K. Hoppel and M. Fromm (2007), A 3D-CTM with detailed online PSC-microphysics: analysis of the Antarctic winter 2003 by comparison with satellite observations, *Atmospheric Chemistry and Physics*, 7(7), 1755-1772, doi:10.5194/acp-7-1755-2007.
- Errera, Q., F. Daerden, S. Chabrilat, J. C. Lambert, W. A. Lahoz, S. Viscardy, S. Bonjean and D. Fonteyn (2008), 4D-Var assimilation of MIPAS chemical observations: ozone and nitrogen dioxide analyses, *Atmospheric Chemistry and Physics*, 8(20), 6169-6187, doi:10.5194/acp-8-6169-2008.
- García, R. R., M. López-Puertas, B. Funke, D. R. Marsh, D. E. Kinnison, A. K. Smith and F. González-Galindo (2014), On the distribution of CO₂ and CO in the mesosphere and lower thermosphere, *Journal of Geophysical Research: Atmospheres*, 119(9), 5700-5718, doi:10.1002/2013JD021208.

THEORETICAL AND MODELLING STUDIES OF THE STRATOSPHERE

Sébastien Viscardy and Quentin Errera

The stratosphere, ranging typically between 10 and 50 km in altitude, has remarkably drawn the attention of the scientific community since the beginning of the 20th century, especially because it contains the ozone layer that protects living species from solar ultraviolet radiation. In addition to laboratory experiments and observations becoming more and more systematic, theoretical approaches have been particularly helpful to increase our understanding of the composition and processes occurring in this part of the atmosphere. However, the tremendous improvements carried out on computer technology gave rise, around 1970, to the use of a new scientific tool, namely numerical modelling, which has permitted simulating the behavior of the atmosphere and predicting its evolution under specific conditions. Over the last forty years, modelling investigations have substantially helped to improve the understanding of phenomena that occur in the stratosphere. Particularly, the ozone layer and its alteration (e.g. due to the emission of anthropogenic pollutants, the solar activity, etc.) have been a subject of intense study.

The first studies related to the stratospheric ozone layer date from the second half of the 19th century. After observing in 1879 that solar radiation at wavelengths shorter than 290 nm did not reach the Earth's surface, Cornu concluded that a specific element of the atmosphere absorbed them. Soon after, Hartley demonstrated that the responsible gas was ozone. Thirty years later, Fabry and Buisson, after measuring very weak ozone concentrations close to the Earth's surface, suggested that larger amounts of this chemical compound would be present in the upper atmosphere. Since then, the so-called stratospheric ozone layer has progressively attracted the attention of scientists and was rapidly considered as a key constituent of the atmosphere.

In this context, in 1930, Chapman proposed the first photochemical mechanism for ozone formation and destruction by considering only oxygen compounds. This theory was a breakthrough but remained of course incomplete. As explained in the previous section, Bates and Nicolet (1950) were the first to describe a catalytic ozone loss through reactions involving hydrogen compounds (HO_x). In the 1960s, Hampson transposed those reactions to the stratosphere but Crutzen demonstrated that they were poorly efficient to destroy ozone in this altitude region and showed, transposing the HO_x scheme to NO_x , that the role of nitric oxide in the ozone formation and destruction was much more substantial. It must be noted that Nicolet had already started much earlier to emphasize the role of nitrogen oxides (initially in the ionosphere). From 1965 to 1973, Nicolet determined the ratio between nitrous oxide (N_2O) and nitric oxide (NO) on which Crutzen's argumentation was based, tackled the question of the origin of nitric oxide, its production by the oxidation of nitrous oxide and its dissociation. Those remarkable results significantly contributed to him being awarded the

prestigious William Bowie Medal in 1984. In 1974, Stolarski and Cicerone also transposed the HO_x scheme to ClO_x catalytic cycle and concluded that chlorine radicals (ClO_x) were the stratospheric compounds contributing most to ozone destruction, while the same year, Molina and Rowland went further in claiming that the chlorofluorocarbons (CFCs), due to their photo-dissociation in the stratosphere, were an important source of those radicals.

From the early 1970s on, BIRA-IASB produced a long series of stratospheric modelling studies, mainly initiated by Brasseur. The models have progressively become more complex incorporating recent advances from laboratory experiments and observations. Moreover, computers improvement contributed to increase their dimensionality. Accordingly, the first models considered only the vertical axis, thus assuming a horizontal homogeneous distribution of chemical species involved in a chemical scheme elaborated by Nicolet. Although simplistic, those models have been helpful to determine the production and loss rates of key species and how the latter are altered under the influence of variations of different factors (e.g. the reaction rates and solar activity).

Continuing studies on nitrogen oxides conducted at BIRA-IASB, Brasseur and Nicolet undertook in 1973, the estimation of the vertical distribution of nitrogen oxides and nitric acid in the stratosphere and mesosphere. Their research showed that nitrogen oxides are very sensitive to the OH concentrations. As a corollary, an increase of water vapor concentrations causes an increase of the amount of nitric acid (HNO_3). Brasseur (1978) extended this model to two dimensions, allowing an investigation of the effects due to the meridian transport. This clearly highlighted the importance of the role of hydrogen and especially of nitrogen compounds on the stability (i.e. the equilibrium between the production and destruction) of stratospheric ozone. Moreover, Brasseur showed that in regions with less sunlight (i.e. where the molecular oxygen is less photolyzed), the meridian transport ensures the transfer of ozone from the equator to polar regions where its concentration is maximum during winter.

In the 1980s, modelling studies were performed to study the impact of the variability of solar activity on the stratospheric temperature and minor atmospheric constituents. Two major solar cycles were mostly considered: namely, the 11-year sunspot cycle and the 27-day solar rotation period. On the effect of short-term solar variability, scientists from Virginia (USA), in collaboration with Brasseur and De Rudder, showed that satellite observations revealed high correlations between ozone concentrations and short-term variations of the Sun. The response of nitric acid, while opposite to ozone's, was even stronger, and the two-dimensional model results obtained at BIRA-IASB were in fair agreement with these observations.

During the 1980s, Brasseur and De Rudder performed different quantitative studies highlighting the impact of anthropogenic pollutants on the stratospheric temperature and the ozone layer. They also tackled the question

Aeronomy in the Middle Atmosphere – A unique book

The research in aeronomy, especially in the middle atmosphere, achieved unprecedented progress in the 1970s. Moreover, this branch of science is so interdisciplinary that a synthesis of the state of knowledge became critical in the early 1980s. In this context, Guy Brasseur together with Susan Solomon (NCAR) provided such a comprehensive treatise which they naturally entitled *Aeronomy in the Middle Atmosphere* (1984).

This textbook is notable for many reasons. Both physics and chemistry of the stratosphere and mesosphere are covered in an extensive way. The text is clearly written and remarkably well-illustrated. The use of informative schemes describing the atmospheric chemistry makes its comprehension much easier to the readers. As a result, the textbook rapidly became a unique reference on those topics.

Aeronomy of the Middle Atmosphere is, in the words of J. M. C. Plane (University of Leeds, UK), "indispensable for anyone interested in the atmospheric regions between about 10 and 110 km in altitude, both as a research and a teaching source."

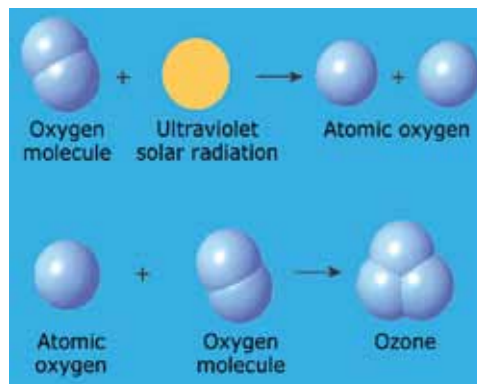

Stratospheric ozone production
(Chapman photochemical mechanism, 1930)

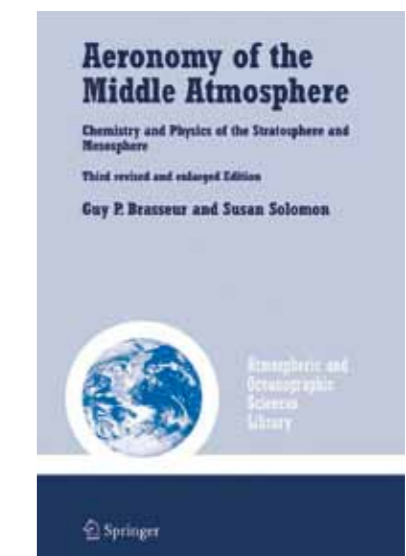

Polar Stratospheric Clouds (PSCs)
clouds, formed in the winter polar stratosphere, of which the particles/droplets act as surfaces for ozone depletion reactions; of central importance in the ozone hole formation mechanism.



Picture of Polar Stratospheric Clouds as observed during the THESEO Arctic field campaign in winter 2000. Picture taken at Esrange, the rocket range and research centre located outside Kiruna in northern Sweden, on 26 January 2000 (courtesy Geir Braathen).

of the future evolution of stratospheric ozone, particularly when assuming a high chlorine perturbation due to the human production of chlorocarbons and other ozone-depleting substances (De Rudder and Brasseur, 1985). These studies actively contributed to the scientific advances leading to the celebrated Montreal Protocol ratified in 1987.

Probably one of the most important breakthroughs in the history of atmospheric sciences took place in 1985 when Farman *et al.* discovered the famous “ozone hole” occurring over Antarctica during the polar Spring. Even though this phenomenon was completely unexpected, it was quickly suggested that polar stratospheric clouds (PSCs), formed during the polar winters, catalyze reactions (much too slow in the gas phase to explain such a phenomenon) which produce the chlorine compounds responsible for the observed ozone depletion. Further observations revealed the existence of three types of PSC particles: the nitric-acid trihydrate, water ice, and liquid droplets composed of sulfuric acid, nitric acid, and water.

From the mid-1990s onwards, modelling investigations conducted at BIRA-IASB, in collaboration with the Danish Meteorological Institute, have contributed to the understanding of the formation of PSCs and their impact on the stratospheric chemical structure. Fonteyn and Larsen (1996) developed a two-dimensional model including all microphysical processes responsible for the formation of PSCs and the relevant heterogeneous reactions occurring on their surfaces. In addition, the effect of particle sedimentation on the final polar ozone loss was underlined and they obtained a PSC climatology in good agreement with existing observations. Daerden and coworkers extended this model to three dimensions, allowing the first simulations of an Antarctic winter that include detailed PSC microphysics and an explicit treatment of sedimentation. This study is currently ongoing at BIRA-IASB using new generations of observational data of PSCs and relevant chemical compounds. Viscardy and his colleagues, in collaboration with Pitts (NASA Langley Research Center, USA), recently demonstrated that such a model is able to reproduce satisfactorily the areas covered by PSCs.

Historical References

Crutzen, P.J. (1970), The influence of nitrogen oxides on the atmospheric ozone content, *Quarterly Journal of the Royal Meteorological Society*, 96(408), 320-325, doi:10.1002/qj.49709640815.

Solomon, S. (1999), Stratospheric ozone depletion: A review of concepts and history, *Reviews of Geophysics*, 37(3), 275-316, doi:10.1029/1999RG900008.

Solomon, S., R. R. Garcia, F. S. Rowland and D. J. Wuebbles (1986), On the depletion of Antarctic ozone, *Nature*, 321, 755-758, doi:10.1038/321755a0.

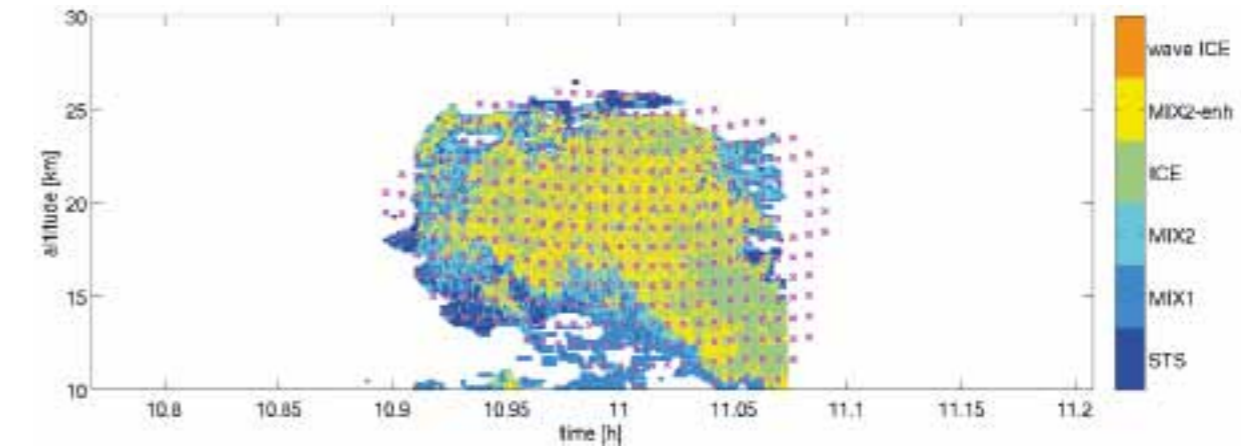

Polar Stratospheric Clouds (PSCs) observed on July 23, 2007 by the satellite CALIPSO (color-coded by PSC composition) along an orbit segment and simulated by our model (crosses in magenta).

Selected References

Brasseur, G. (1978), Un modèle bidimensionnel du comportement de l’ozone dans la stratosphère, *Planetary Space Science*, 26(2), 139-159, doi:10.1016/0032-0633(78)90014-4.

Brasseur, G. and M. Nicolet (1973), Chemospheric processes of nitric oxide in the mesosphere and stratosphere, *Planetary Space Science*, 21(6), 939-961, doi:10.1016/0032-0633(73)90141-4.

Brasseur, G. and S. Solomon (1984), *Aeronomy of the middle atmosphere: chemistry and physics of the stratosphere and mesosphere*, D. Reidel, Dordrecht.

De Rudder, A. and G. Brasseur (1985), Ozone in the 21st Century: Increase or Decrease?, in *Atmospheric Ozone: Proceedings of the Quadrennial Ozone Symposium held in Halkidiki, Greece 3-7 September 1984*, edited by Zerefos, C.S. and A. Ghazi, pp. 92-96, Springer, Dordrecht.

Fonteyn, D. and N. Larsen (1996), Detailed PSC formation in a two-dimensional chemical transport model of the stratosphere, *Annales Geophysicae*, 14(3), 315-328, doi:10.1007/s00585-996-0315-0.

Keating, G. M., J. Nicholson, G. Brasseur, A. De Rudder, U. Schmailzl and M. Pitts (1986), Detection of stratospheric HNO₃ and NO₂ response to short-term solar ultraviolet variability, *Nature*, 322, 43-46, doi:10.1038/322043a0.

TROPOSPHERIC MODELLING

Jean-François Müller and Trissevgeni Stavrou

The troposphere – the lowermost atmospheric layer, in direct contact with the Earth’s surface – was not a topic of research at BIRA-IASB until 1988, when tropospheric composition modelling became the main focus of a PhD thesis carried out under the supervision of Guy Brasseur. In retrospect, the absence of tropospheric studies at BIRA-IASB during the first decades of its existence might sound surprising given the tremendous interest received by tropospheric composition since then – after all, the air we breathe is tropospheric, unfortunately not as pure as we’d like it to be, and tropospheric composition changes are believed to be the single most important cause of anthropogenic climate change. But attitudes towards (un)clean air were different back then: people were allowed to smoke about everywhere, the Rio Conference was yet to come, and with it the concept of sustainable development.

Matters were slightly different in the United States, where severe air pollution (smog) in major cities had prompted regulations of pollutants emissions as well as sustained efforts to understand its causes. In the late 1980s, it was realized that smog was more than just a local phenomenon due to human activities in big cities. Understanding its causes required a global view considering (among others) the critical role of long-range transport of pollutants and the huge amounts of hydrocarbons released by vegetation, known to participate in smog formation through complex chemical processes. Clearly, a global tropospheric chemistry model was in order. It had to be three-dimensional (longitude, latitude, altitude) due to the strong heterogeneity of tropospheric composition; and it had to account for all major processes – transport, chemistry, emissions and deposition – known to influence the concentrations of key pollutants.

The development of such a model was to be the main objective of the above-mentioned PhD student (Jean-François Müller). Guy Brasseur, having recently left Belgium to the United States, where he would head first a section, then an entire division of the National Center for Atmospheric Research (NCAR), Jean-François Müller was lucky enough to mingle with leading scientists in the field through frequent visits to that institution. Access to Cray-type supercomputers was also not the least advantage derived from this visiting scientist status.

A preliminary step towards the realization of the global model was the compilation of the first global *gridded* (latitude-longitude) emission inventory covering all major pollutant emission sources, including among others, fossil fuel extraction and combustion, industrial processes, forest and savanna fires, lightning and vegetation. The collection of data being what it was in the pre-internet era, visits to libraries and embassies of large countries were paid to gather economic information required to estimate anthropogenic emissions. The estimation of hydrocarbon emissions due to vegetation relied on the most recent observations collected at NCAR in combination with geographically referenced ecosystem and meteorological databases.

The resulting global emission inventory was the first of its kind, although its level of detail and coarse horizontal resolution ($5^{\circ}\times 5^{\circ}$) might make it seem ridiculous today in comparison with current standards. Next, the other major building blocks of the new model were developed: a model for the transport of chemical compounds by the winds, a model for “subgrid” mixing in clouds and the boundary layer, and a module for the effects of chemistry. The set of chemical reactions was unusually large, since it had to describe the chemistry of major hydrocarbons emitted by trees. In spite of the large computing resources available, elaborate tricks had to be invented to limit the computational costs represented by three-dimensional simulations of about 50 chemical compounds for a period of typically 2 years. Even so, a single simulation of the new model, named IMAGES (Intermediate Model for the Annual and Global Evolution of Species), took weeks to run on a supercomputer.

This model (Müller and Brasseur, 1995) was the first global model accounting for the impact of biogenic hydrocarbons. It has been used in numerous studies since then, at NCAR and BIRA-IASB, investigating for example, the impact of emissions due to human activities, to vegetation fires, and to aircraft exhaust, sometimes in the framework of international assessments of the Intergovernmental Panel on Climate Change (IPCC). It has been used to disentangle the contributions of different sources to the budget and distributions of compounds responsible for smog formation like carbon monoxide and nitrogen oxides. From such studies came the idea to use models like IMAGES as tools to put quantitative constraints on the distributions of the emissions.

This so-called *inverse modelling* of emissions, i.e. their optimization based on a given set of atmospheric observations, has been actively pursued at BIRA-IASB, especially since satellite observations of tropospheric

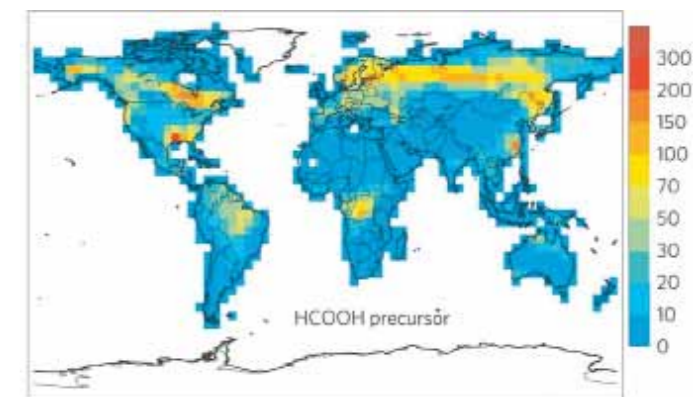

Emissions of unknown formic acid precursors deduced by inverse modelling of satellite data, for the month of July 2009 ($\mu\text{g C m}^{-2} \text{ s}^{-1}$). Reprinted from *Nature Geosci.*

Emissions of isoprene released by vegetation in July, (left) according to the first gridded inventory for that compound, published in 1992 (Source: *J. Geophys. Res.*), and (right) according to the combination of inverse modelling using satellite data and state-of-the-art emission modelling.

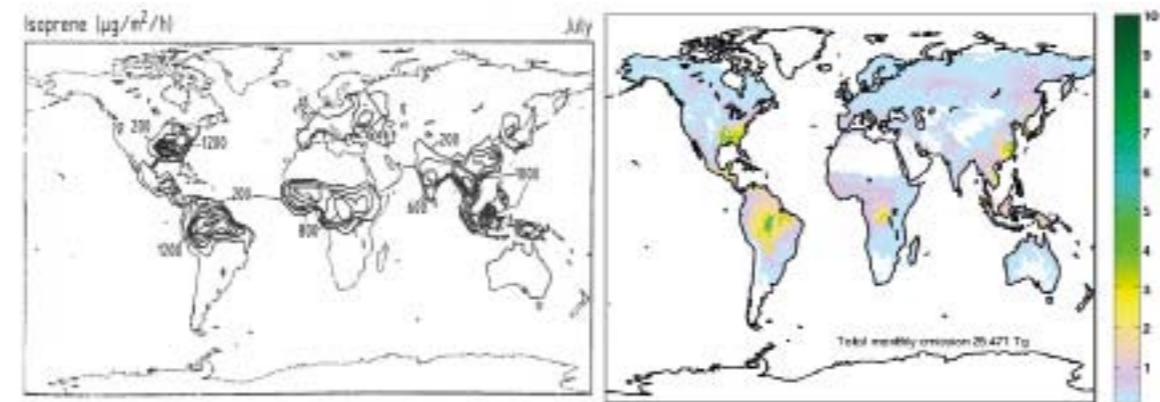

chemical compounds have become available in the late 1990s and early 2000s. An advanced inverse modelling methodology was developed to make the most profitable use of these observations. For example, the decade-long time series of NO_2 observations from the spaceborne GOME and SCIAMACHY instruments was used to demonstrate the effect of emission regulations on NO_x emissions in Western Europe and in the United States, and to witness and quantify the fast emission increase in China consecutive to its formidable economic expansion since the mid-1990s. Observations of organic compounds from the same instruments were used to constrain hydrocarbon emission due to vegetation and to vegetation fires. Even better, observations of formic acid from space were used to reveal the existence of an unexpectedly large source of this compound due to the oxidation of biogenic hydrocarbons. Formic acid was shown to be the dominant source of cloud and rain acidity over areas such as Amazonia and Siberia.

The fact that such a large formic acid source remains as yet unexplained illustrates perfectly the vast ocean of our ignorance regarding the emissions and degradation mechanisms of large biogenic hydrocarbons. These compounds are however believed to be the dominant source of organic aerosol, itself the largest single component of fine particulate matter over continents. At a conference in Bologna in 1998, some pessimistic (or realist?) scientists concluded that the effects of biogenic hydrocarbon oxidation simply cannot be known from laboratory experiments, because laboratory conditions are too different from the real world, and because thousands of chemical reactions are at play. This provocative statement initiated a long-term effort at BIRA-IASB, in collaboration with a team at KU Leuven led by Jozef Peeters, aiming at reducing this knowledge gap and developing models capable of handling the complex chemistry of biogenic hydrocarbons. Although this objective still isn't achieved today, considerable progress has been made, and thousands of reactions are taken into account in our models which also calculate aerosol formation, with some success. These developments prove that our approach, although difficult, is a fruitful one.

Selected References

Müller, J.-F. (1992), Geographical distribution and seasonal variation of surface emissions and deposition velocities of atmospheric trace gases, *Journal of Geophysical Research: Atmospheres*, 97(D4), 3787-3804, doi:10.1029/91JD02757.

Müller, J.-F. and G. Brasseur (1995), IMAGES: A three-dimensional chemical transport model of the global troposphere, *Journal of Geophysical Research: Atmospheres*, 100(D8), 16445-16490, doi:10.1029/94JD03254.

Müller, J.-F. and T. Stavrou (2005), Inversion of CO and NO_x emissions using the adjoint of the IMAGES model, *Atmospheric Chemistry and Physics*, 5(5), 1157-1186, doi:10.5194/acp-5-1157-2005.

Stavrou, T., J.-F. Müller, J. Peeters, A. Razavi, L. Clarisse, C. Clerbaux, P.-F. Coheur, D. Hurtmans, M. De Mazière, C. Vigouroux, N. M. Deutscher, D. W. T. Griffith, N. P. Jones and C. Paton-Walsh (2012), Satellite evidence for a large source of formic acid from boreal and tropical forests, *Nature Geoscience*, 5, 26-30, doi:10.1038/ngeo1354.



(credit: AFP Photo/Wang Zhao)

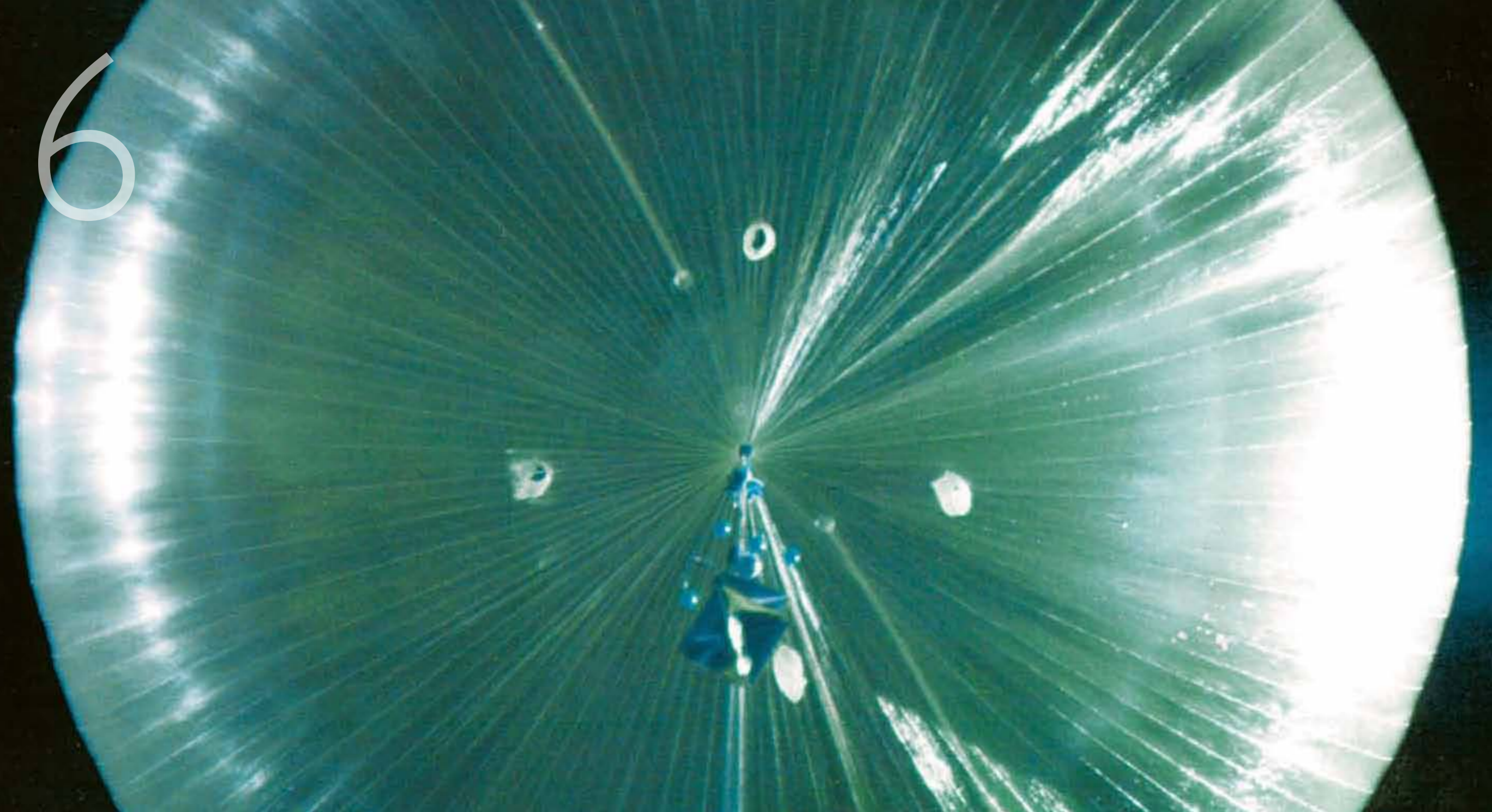

BELGISCH INSTITUUT VOOR RUIMTE-AERONOMIE (BIRA) INSTITUUT D'AERONOMIE SPATIALE DE BELGIQUE (IASB) BELGIAN INSTITUTE FOR SPACE AERONOMY (BIRA-IASB) BELGISCH INSTITUUT VOOR RUIMTE-AERONOMIE (BIRA) INSTITUUT D'AERONOMIE SPATIALE DE BELGIQUE (IASB)

BALLOON OBSERVATIONS

Christ Amelinck and Paul C. Simon

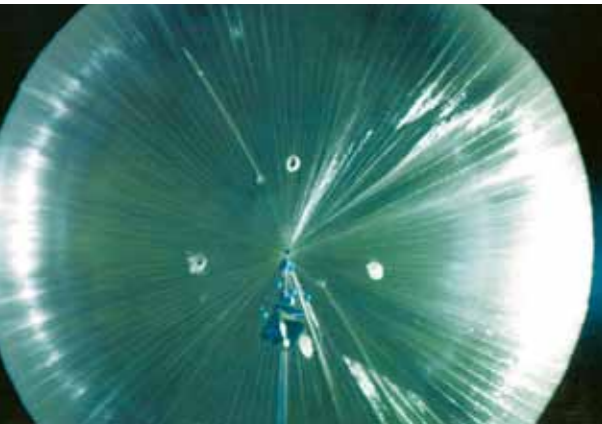

Jean-Pierre Pommereau (LATMOS)

Stratospheric balloon at ceiling altitude, fully inflated. Photography taken from the the gondola. (credit: CNES)

The first hot air balloon and aerostat (gas balloon) flights by respectively the Montgolfier brothers, and Jacques Charles and the Robert brothers in France, have opened a large interest among scientists for exploring the Earth's atmosphere. Flying on manned balloons, the Belgians Etienne Gaspar Robertson and Auguste Lhoest from Liège announced a magnetic field and air concentration reduction with altitude up to 3000 m in 1803. The Frenchmen Jean-Baptiste Biot and Louis Gay-Lussac made a first ascent in a hydrogen ballon on 24 August 1804 with the primary objective to verify whether the magnetic intensity at the earth's surface indeed decreased with an increase in altitude. They concluded that it was constant up to 4000 meters. Gay-Lussac made a second ascent by himself about three weeks later, allowing him to reach a higher altitude of about 7000 m. He was able to measure the temperature, pressure, humidity, and demonstrated the constant air composition and magnetic intensity, in contradiction with the previous findings. Then, because of lack of funding, according to Flammarion, no more flights were attempted until 1850 when Jean Augustin Barral and Jacques Alexandre Bixio measured a temperature of -39°C at 7039 m and even ice crystals were found, interpreted by François Arago as condensation nuclei at the origin of hail formation and halos in the sky. This was followed by the first humidity measurements by the British James Glaisher and Henry Tracey Coxwell, and by the attempt at 8600 m in 1875 of Joseph Crocé-Spinelli, Théodore Sivel and Gaston Tissandier, during which the two first died because of the too high altitude for humans to survive. Finally, the Germans Arthur Berson and Reinhard Süring reached in 1901 a record altitude of 10530 m using oxygen bottles. For reaching higher altitudes, a pressurised gondola was used by the Swiss Auguste Piccard who reached 15781 m with Paul Kipfer in 1931 and 16201 m with the Belgian Max Cosyns in 1932, for investing cosmic rays, a technique further applied by the U.S.S.R. air force with

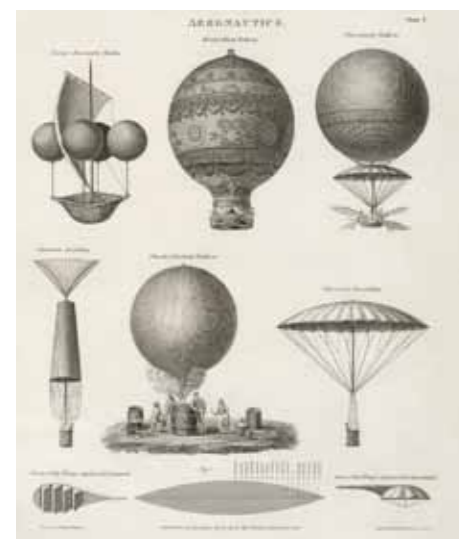

Early balloon designs: “Lana’s aeronautic machine,” “Montgolfiers’ balloon,” “Blanchard’s balloon,” “Garin ascending and descending” in his parachute, the “Charles & Roberts’ balloon” being inflated, the “form of the wings employed by Lunardi,” and the “form of the wings employed by Blanchard.”

a record altitude of 21872 m for a manned balloon. These first explorations of the stratosphere were followed by the flight of Cosyns and Nerée Van der Elst in 1934, who reached Zenvlje in Slovenia (\pm 1800 km from Hour in Belgium, record of distance at that time) at an altitude of 15500 m.

Next important step regarding the atmosphere was the development in the 1890s of unmanned meteorological balloons in paper, silk and rubber, carrying small pressure and temperature sensors and an onboard paper recorder. It is with these new balloons that Léon Teisserenc de Bort and Richard Assman discovered in 1902 the warming of the atmosphere above 11-12 km, that is the existence of the tropopause and the stratosphere, in contradiction with the generally accepted idea of a permanent cooling of the atmosphere with altitude up to zero Kelvin around 50 km. Further most important progress in the field was the development of a radio transmitter by Pierre Idrac and Robert Bureau at the French National Office of Meteorology in 1918 allowing the transmission of temperature, pressure, humidity, wind speed and direction measurements, independently of the improbable recovery of the payload, leading to the concept of radiosonde. First used in 3 stations during the International Polar Year in 1931-1932, the concept was adopted by the international meteorological community after the second world war, performing now twice a day ascents from 200 stations distributed around the world, which is about 550 000 ascents per year.

The next major step in ballooning was the use of polyethylene material and helium for inflation, as tested first by Otto Winzen in 1947 in Minnesota, a technique rapidly adopted by the US Air Force and Navy for high altitude manned and unmanned flights, but also by John Winckler and Edward Ney at the University of Minneapolis for scientific research applications, the subject of this chapter.

The merit of the development of a scientific balloon program in Europe, used later by BIRA-IASB, French and more generally all European scientists, returns to Jacques Blamont, director of the CNRS Service d'Aéronomie laboratory in France, who, after a post-doc at the University of Minneapolis in 1958, convinced the French space research committee to invest in a balloon program. He rapidly built a technical team under the lead of Robert Régipa. After few test flights in France, a first successful field campaign, consisting of three flights, took place in 1962 in Kerguelen Island, the magnetic conjugated location of Minneapolis in the Southern Hemisphere. Soon after, five balloons were flown from a new range in Aire-sur-l'Adour in South West France, next to the “POTÉZ” facility where the balloons manufacturing was also transferred to, and another range built in Gap-Tallard in the South-East of France for summer flights, when stratospheric winds are blowing from the East. In

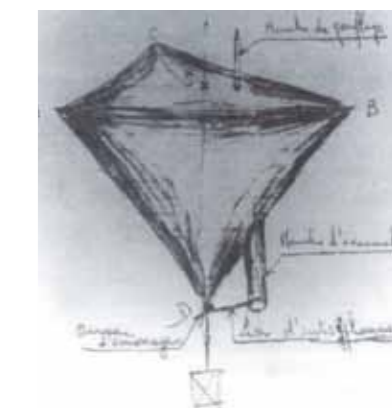

The first sketch of a tetrahedral balloon at ceiling altitude drawn by Robert Régipa. This kind of stratospheric balloons were the first used for scientific flights by CNES and, in the late sixties, by BIRA-IASB. (courtesy Robert Régipa, private collection)



Inflating phase of stratospheric balloon in Gap (France), at sunrise. (credit: CNES).

In 1965 all balloon activities were transferred from CNRS to the “Centre national d’Études spatiales” (CNES). The balloon manufacturer was changed later for “Zodiac Espace”. Larger balloons of up to 400000 m³ volume were developed for carrying payloads of up to 500 kg, offering to European scientists a powerful tool for new ambitious atmospheric and astronomic research programs, a facility which would be used very soon by BIRA-IASB.

Selected References

Blamont, J. (2011), Première partie, Histoire, in Les ballons au service de la recherche: l'aérostation scientifique des origines à nos jours, edited by Lebeau, A. and J.-P. Sanfourche, pp. 25-60, Editions Edite & Institut Français de l'Histoire de l'Espace, Paris.

Régipa, R. (2011), Deuxième partie, L'arrivée du ballon stratosphérique, in Les ballons au service de la recherche: l'aérostation scientifique des origines à nos jours, edited by Lebeau, A. and J.-P. Sanfourche, pp. 61-80, Editions Edite & Institut Français de l'Histoire de l'Espace, Paris.



Take off in Aire sur l'Adour in France (credit: CNES).

Payload landing in the countryside. (credit CNES).



Beginning of the balloon ascent after release, the payload still hanging at the auxiliary balloon. (credit: CNES).

SOLAR UV RADIATION

Paul C. Simon

Stratospheric ozone is mainly produced by the photodissociation of molecular oxygen in the upper stratosphere, around 40 km altitude, corresponding to the so-called “atmospheric window” for solar radiation around 200 nm. Indeed, the absorption of solar UV irradiances by molecular oxygen is decreasing rapidly in the wavelength range from 200 to 242 nm. The ozone absorption spectrum is also decreasing significantly towards shorter wavelengths. The interval 200-240 nm is therefore particularly important for the ozone budget in the stratosphere.

As stratospheric balloons were able to reach this altitude, the measurement of in situ ultraviolet solar irradiance in that range was possible. First attempts were made by Brewer and Wilson (University of Toronto) in 1964 using a balloon-borne radiometer. In 1968 and 1969, the instrumentation and the experimental procedure were significantly improved at BIRA-IASB by Marcel Ackerman, Dirk Frimout and Roger Pastiels and, in these two years, three flights took place. From spectra obtained for different solar elevations, the ultraviolet irradiance outside the Earth’s atmosphere was deduced by extrapolation to zero air mass (i.e. at a solar elevation of 90°).

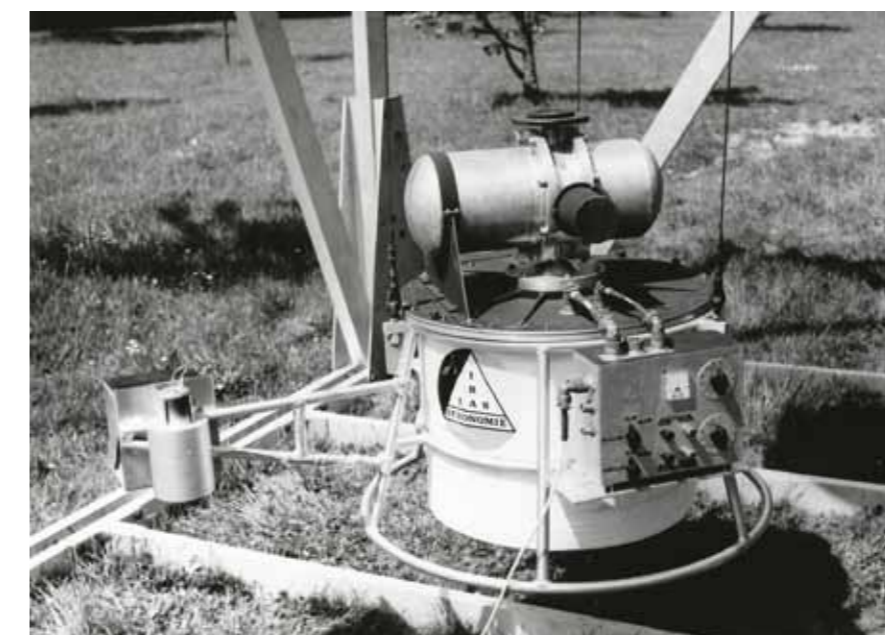

Gondola with UV spectrometer for balloon flights in 1968 and 1969.



Payload recovery in the countryside.

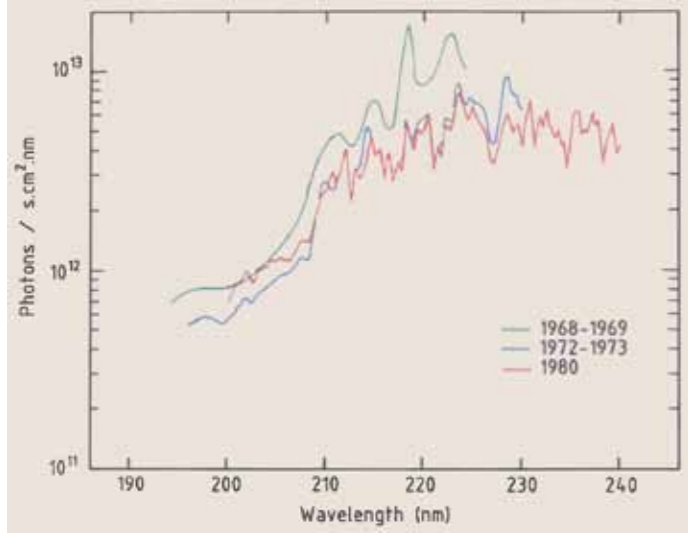

Solar extraterrestrial irradiances between 195 and 240 nm determined with the observations from the new stratospheric balloon spectrometer developed at BIRA-IASB.

In the beginning of the seventies, a new instrument, first developed successfully for rocket solar irradiance measurement, was adapted for balloon observations and integrated in a stabilised gondola, pointing to the Sun at the ceiling altitude. Flights took place in 1972 and 1973, providing new reliable values, which were adopted by the international community for photodissociation calculations and stratospheric modelling. Flights were repeated later, in 1976 and 1977, for minimum and low solar activity conditions in order to detect possible long term variation associated with the 11-year activity cycle of the Sun.

The know-how in ultraviolet radiometric calibration and in instrumentation for solar observations led to a successful proposal for the Spacelab I mission in 1978, made in collaboration with the “Service d’Aéronomie” of the “Centre National de la Recherche Scientifique” (CNRS, France), the “Landessternwarte Königstuhl” (Heidelberg, Germany) and the “Hamburger Sternwarte” (Hamburg-Bergedorf, Germany).

In parallel with the balloon-borne observation, full disc solar irradiation fluxes between 150 and 210 nm have been determined by Denys Samain and Paul C. Simon in 1976, from rocket radiance spectra obtained in 1973 by Samain and co-workers. Their results published in 1974 confirmed the balloon-borne observations obtained in 1972 and 1973 around 200 nm.

Selected References

- Ackerman, M. and Simon, P. (1973), Rocket measurement of solar fluxes at 1216 Å, 1450 Å and 1710 Å, *Solar Physics*, 30(2), 345-350, doi:10.1007/BF00152666.
- Ackerman, M., D. Frimout and R. Pastiels (1971), New ultraviolet solar flux measurements at 2000 Å using a balloon borne instrument, in *New Techniques in Space Astronomy*, IAU Symposium no. 41, Munich, August 10-14 1970, edited by Labuhn, F. and R. Lüst, pp. 251-253, Springer, Dordrecht.
- Brasseur, G. and P.C. Simon (1981), Stratospheric chemical and thermal response to long-term variability in solar UV irradiance, *Journal of Geophysical Research: Oceans*, 86(C8), 7343-7362, doi:10.1029/JC086iC08p07343.
- Frederick, J. E., C. Leovy, D. E. Anderson, G. P. Anderson, R. E. Dickinson, S.R. Drayson, S. Fels, L. A. Hall, J. Kiehl, J. E. Mentall, G. H. Mount, M. Nicolet, C. D. Rodgers, G. Rottman and P.C. Simon (1985), Chapter 7: Radiative Processes: Solar and Terrestrial, in *Atmospheric ozone 1985: assessment of our understanding of the processes controlling its present distribution and change*, Vol. 1, WMO Global Ozone Research and Monitoring Project, Report no. 16, pp. 349-392, NASA, Washington D.C.
- Samain, D. and P.C. Simon (1976), Solar flux determination in the spectral range 150-210 nm, *Solar Physics*, 49(1), 33-41, doi:10.1007/BF00221483.
- Simon, P.C. (1974), Balloon Measurements of Solar Fluxes between 1960 and 2300 Å, in *Proceedings of the Third Conference on the Climatic Impact Assessment Program*, February 26-March 1 1974, Cambridge, Mass, Dept. Transportation report DOT-TSC-OST-74-15, edited by Broderick A. J. and T. M. Hard, pp. 137-141, U.S. Govt. Print. Off., Washington D.C.
- Simon, P.C. (1978), Irradiation solar flux measurements between 120 and 400 nm. Current position and future needs, *Planetary and Space Science*, 26(4), 355-365, doi:10.1016/0032-0633(78)90119-8.
- Simon, P.C. (1981), Solar irradiance between 120 and 400nm and its variations, *Solar Physics*, 74(1), 273-291, doi:10.1007/BF00151296.
- Simon, P.C., R. Pastiels and D. Nevejans (1982), Balloon observations of solar ultraviolet irradiance at solar minimum, *Planetary and Space Science*, 30(1), 67-71, doi:10.1016/0032-0633(82)90073-3.

INFRARED REMOTE SENSING FROM STRATOSPHERIC BALLOONS

Christian Muller

In 1963, Marcel Ackerman proposed to study solar absorption spectroscopy at very high zenith angles including even pointing below the horizon from either a mountain observatory or a high altitude stratospheric balloon leading to the first internal study report of the institute. The advantage of sounding the limb had been known for a long time by Marcel Nicolet for determining the influence of the Sun on the ionosphere before sunrise and after sunset.

The application to observations had not been envisaged because of the technological difficulties of pointing precisely balloon payloads. The technical solution came from a stabilised, solar pointing, balloon gondola: the Astrolabe, developed by CNES in 1964. BIRA-IASB was the first to operate it successfully. The first infrared spectrometer on board was an Ebert-Fastie spectrometer, designed and built at the institute. The use of a quite low sensitivity detector imposed a very luminous instrument with a low spectral resolution, compared to today's standards. This instrument, operating in the 2.7 micrometer atmospheric window from an altitude of 35 km, showed absorption spectra of methane and nitrous oxides. Marcel Nicolet knew that these constituents were source gases of nitrogen oxides and hydrogen compounds in the upper atmosphere. They could thus intervene in stratospheric ozone chemistry and in the ion production in the upper stratosphere. Moreover, a spectrum obtained just above the tropopause was showing a supplementary absorption corresponding to a weak band of nitrogen dioxide. Nevertheless, everyone was surprised at that time to observe absorption lines of nitrogen dioxide.

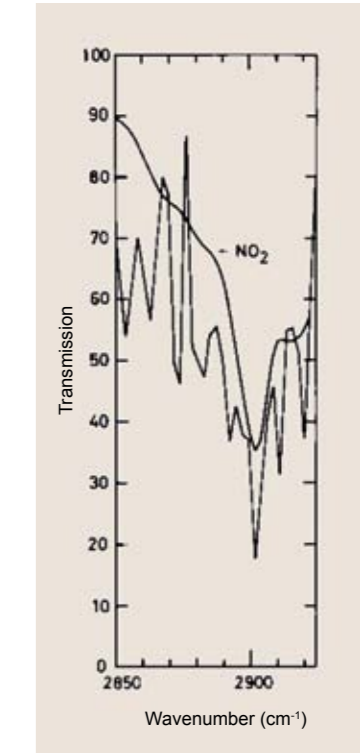

A typical spectrum, obtained in October 1970 from Aire-sur-l'Adour. The instrument was pointing at a grazing altitude of 12.5 km. The high simulated nitrogen dioxide value (upper smooth curve) probably indicates an intrusion of tropospheric air in the stratosphere.

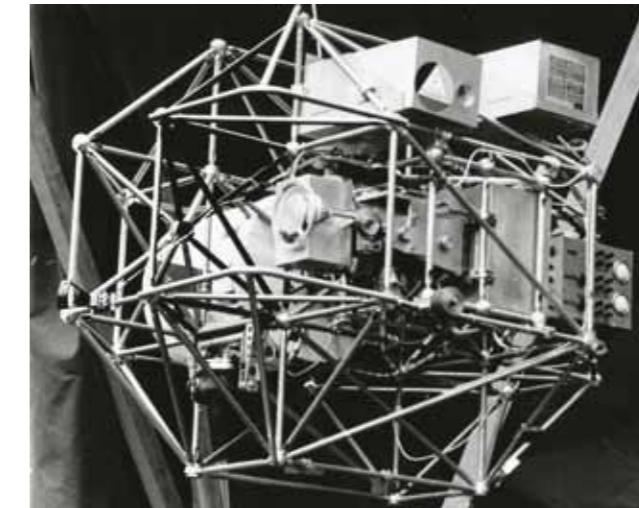

Stabilised gondola “Astrolabe” with the infrared spectrometer during the preparation for its balloon flight on 10 June 1970.

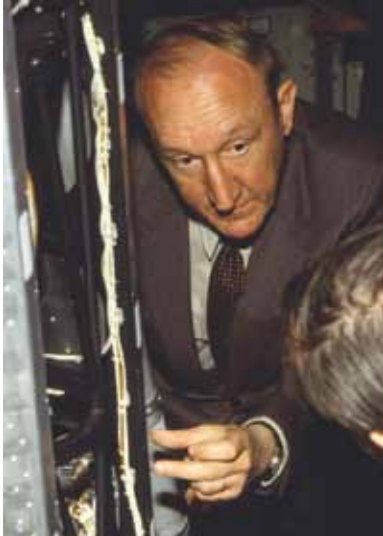

André Girard from ONERA (France), inventor of the Grille spectrometer.

The Girard's "grille". The luminosity of the spectrometer corresponds to the entire grille while the resolution is similar to the resolution of an ordinary grating spectrometer with the slits open at the smallest interval between the hyperboles. This result requires of course perfect realisation and alignment.

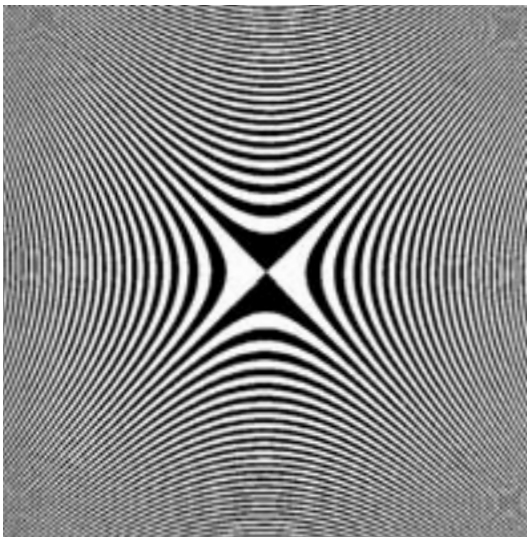

The subject probably would have stayed academic if it had not been related to the ozone impact of the supersonic transport aircrafts. Soon after the first Concorde flight in 1969, Harold Johnston, professor of chemistry at the University of Berkeley, stated that nitrogen oxides emitted by aircraft in the stratosphere might cause substantial depletion of the ozone layer through catalytic reactions (see chapter 9).

BIRA-IASB already obtained the NO_2 spectrum by balloon and, hence, knew that the ozone layer was in equilibrium with natural nitrogen oxides.

Due to its importance for the supersonic transport issue, the BIRA-IASB project got fresh financing, which led to the study of a new spectrometer with a liquid nitrogen cooled detector: the Girard's infrared grille spectrometer. It was an extraordinary design with the slits replaced by a hyperbolic grille, thus combining high resolution and high luminosity. Again, the instrument was built and designed at the Institute in close collaboration with the team of André Girard who provided also his optical expertise.

The grating and the choice of orders had been optimised for the simultaneous observation of NO and NO_2 . The instrument performed the first stratospheric observation of nitric oxide ever. The first Girard's infrared grille spectrometer flew successively on the Concorde prototype and on a stratospheric balloon in 1973. The publication of these results together with the observation by an American group of nitric acid in the lower

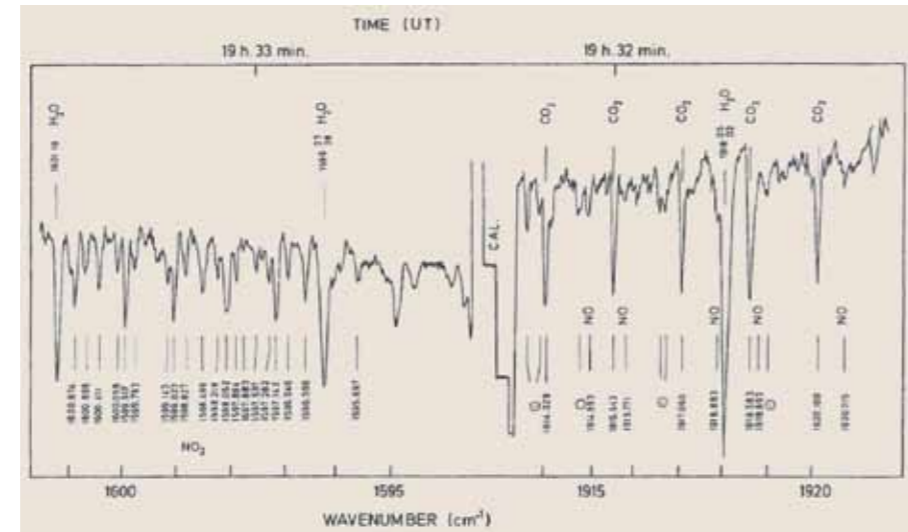

Stratospheric spectrum obtained on May 13, 1974 showing both orders of the grille spectrometer and lines of NO and NO_2 in the 30 km limb altitude range. The entire NO_2 spectrum may be used for interpretation but only the NO line with wavenumber 1914.993 is free from overlapping by solar CO and isotopic telluric CO_2 lines. As the spectroscopic databases were limited at the time, these contamination discussions were frequent.

stratosphere demonstrated that stratospheric nitric oxides had a natural source and sink. This point, together with supporting models, led the authorities of the United States, France and UK to agree on experimental commercial operations of stratospheric supersonic transport planes.

The programme went on, showing in subsequent balloon flights important temporal variations of nitrogen oxides. A 1975 flight, aimed at hydrogen chloride, also provided the first observation of this molecule in the stratosphere. However, two nearly simultaneous flights by American groups also observed hydrogen chloride lines and the anteriority conflict that resulted from this fact was never fully resolved.

In 1977, the design of the space-borne grille spectrometer had begun and the Institute preferred to give priority to global coverage from space with the development of a new generation of infrared grille spectrometer. The infrared balloon programme was never resumed.



Stabilised gondola "Astrolabe" with the infrared grille spectrometer.

Selected References

- Ackerman, M. (1974), Stratospheric water vapor from high resolution infrared spectra, *Planetary and Space Science*, 22(8), 1265-1267, doi:10.1016/0032-0633(74)90009-9.
- Ackerman, M. (1975), NO, NO_2 and HNO_3 below 35 km in the atmosphere, *Journal of Atmospheric Science*, 32(9), 1649-1657, doi:10.1175/1520-0469(1975)032.
- Ackerman, M. (1976), Measurements of Minor Constituents in the Stratosphere, in *Atmospheric physics from Spacelab*, Astrophysics and Space Science Library, Vol. 6, edited by Burger, J.J., A. Pedersen and B. Battrock, pp. 107-116, Springer, Dordrecht.
- Ackerman, M. and C. Muller (1973), Stratospheric methane and nitrogen dioxide from infrared spectra, *Pure and Applied Geophysics*, 106-108(1), 1325-1335, doi:10.1007/BF00881086.
- Ackerman, M., D. Frimout, J.-C. Fontanella, A. Girard, R. Gobin, L. Gramont and N. Louisnard (1973), Air-borne and balloon-borne spectroscopy for the study of atmospheric gas pollutants, *Instrument Society of America, J.S.P.*, 6659, 39-47.
- Ackerman, M., D. Frimout, C. Muller, D. Nevejans, J.-C. Fontanella, A. Girard and N. Louisnard (1973), Stratospheric nitric oxide from infrared spectra, *Nature*, 245, 205-206, doi:10.1038/245205a0.
- Ackerman, M., D. Frimout, C. Muller, D. Nevejans, J. C. Fontanella, A. Girard, L. Gramont and N. Louisnard (1974), Recent Stratospheric Spectra of NO and NO_2 , *Canadian Journal of Chemistry*, 52(8), 1532-1535, doi:10.1139/v74-225.
- Ackerman, M., J.-C. Fontanella, D. Frimout, A. Girard, N. Louisnard and C. Muller (1975), Simultaneous measurements of NO and NO_2 in the stratosphere, *Planetary and Space Science*, 23(4), 651-660, doi:10.1016/0032-0633(75)90105-1.
- Ackerman, M., D. Frimout, A. Girard, M. Gottignies and C. Muller (1976), Stratospheric HCl from infrared spectra, *Geophysical Research Letters*, 3(2), 81-83, doi:10.1029/GL003i002p00081.
- Ackerman, M., D. Frimout and C. Muller (1977), Stratospheric CH_4 , HCl and ClO and the chlorine-ozone cycle, *Nature*, 269, 226-227, doi:10.1038/269226a0.

BALLOON INTERCOMPARISON CAMPAIGNS

Jean-Pierre Pommereau (LATMOS) and Paul C. Simon

A wide variety of instruments have been used in the past for measuring the vertical distribution and the total column of stratospheric ozone by ground-based, in situ and remote sensing balloon and satellite techniques. They required careful performance evaluations, selections and often corrections in order to build a reliable database. This was the role of the many Balloon Intercomparison Campaigns carried out at the international level since the early eighties.

The first campaign of balloon-borne and ground-based instruments comparison dedicated to ozone measurements from the surface to the mesosphere was performed in France, from 9 to 26 June 1981. The campaign involved co-located satellite and balloon-borne measurements at several sites in Southern France and was coordinated by Marie-Lise Chanin (Service d'Aéronomie of CNRS, France, renamed later LATMOS).

The goal was to provide a first assessment of the accuracy of some currently available ozone sensors. A total of 11 experimental groups from Belgium (BIRA-IASB), France and USA participated in the campaign with 15 different types of instruments, combining ground-based (Dobson spectrometer direct Sun and Umkher retrievals at Mount Chirán, high-resolution IR absorption interferometer and differential absorption Lidar) and a variety of balloon sensors. Two large stratospheric balloons were launched respectively on 19 June and 25 June 1981 from Gap-Tallard in South East France. Their payload consisted of five instruments: a Brewer-Mast sonde, a UV absorption photometer, a chemiluminescence sensor and two solar UV absorption radiometers, including one developed at BIRA-IASB. Electrochemical Concentration Cell (ECC) sondes were flown simultaneously. Systematic differences as large as 20% between ozone profiles derived from solar UV absorption and in situ techniques were reported during this first attempt demonstrating the need of further improvements in instrumentation and retrieval methodologies.

Soon after Crutzen's suggestion in 1970 of the important role of nitrogen oxides (NO_x) on stratospheric ozone and the threat to ozone of the emission of these gases by a fleet of high altitude supersonic Concorde aircraft, built in France and UK (see chapter 9), a number of instruments were designed for measuring the NO_x compounds and flown on high altitude balloons. The first instrument flown was the infrared grille spectrometer of ONERA, in collaboration with BIRA-IASB, in 1973 (see chapter 6), soon followed by UV-visible spectrometers in Japan and France, mid-IR spectrometers in UK, FTIR and microwave instruments in the US, etc. However, large differences were observed between the NO and NO_2 retrieved concentrations reported by the various instruments, requiring further investigation and reduction before reliable NO_x information could be obtained.

This was the objective of a Balloon Intercomparison Campaign (BIC) initiated by NASA and held at the US National Scientific Balloon Facility (NSBF) in Palestine, Texas in 1982. Thirteen instruments were distributed on four gondolas mounted on large 1500000 m^3 balloons to be flown in parallel on the same day. Unfortunately, the launch of one of them failed but the experiment was repeated, with full success, the year after. The results of these simultaneous measurements by a variety of techniques helped to understand the differences originating from spectroscopic data uncertainties and profile retrieval techniques, resulting in a significant reduction of differences between NO_x measurements, as well as in the qualification of satellites instruments (FTIR ATMOS on board the Space Shuttle and the microwave spectrometer on board NASA UARS) whose prototypes were flown during BIC in preparation of space flights.

Another balloon campaign, the Balloon Ozone Intercomparison Campaign (BOIC), taking place in the US in 1983-1984, focussed on small in situ instruments dealing with the measurement of ozone, to characterise the accuracy of such instruments under development compared to those flown operationally.

Altogether, the above balloon campaigns resulted in a great improvement of the performance and accuracy of sensors measuring ozone and NO_x on board balloons, in situ and remotely, as well as from space, which was of great help for the better understanding of the ozone and NO_x photochemistry.

The MAP/GLOBUS Campaigns

Another open question by that time relative to stratospheric nitrogen oxides (NO_x) species was the amplitude of their diurnal variation because of the photochemical reactions leading to the fast change of their concentrations at sunset and sunrise, and their variations during day and night. To this end, an international project on stratospheric chemistry and dynamics, the "Global Budget of Stratospheric Trace Constituents" (GLOBUS) was implemented in the frame of the "Middle Atmosphere Programme" (MAP) of the Scientific Committee on Solar-Terrestrial Physics (SCOSTEP). Two new balloon campaigns were set up in Aire-sur-l'Adour (South West France) in 1983 and 1985. The 1983 campaign, which dealt with the measurements of short- and long-lived species like ozone, nitrogen oxides, halocarbons and various radicals in the stratosphere, involved the flight of 19 instruments including newly developed in situ chemiluminescent sensors, matrix isolation and cryogenic samplers, the BIRA-IASB ion mass spectrometer and an UV spectrometer, and the prototype of the German CRISTA cryogenic IR spectrometer in preparation for a Space Shuttle flight. Thirteen balloon flights were performed in 1983, including the first ever made slow descent by releasing the gas of the balloon allowing in situ sensors to perform high-resolution altitude sampling. Complementary measurements on the ground, aboard airplanes, and by several rockets and satellite instruments were also performed. The 1985 campaign was more specifically dedicated to NO_x studies to better understand the still disputed total NO_x concentration in the stratosphere and the partitioning between NO_x chemical species and their diurnal

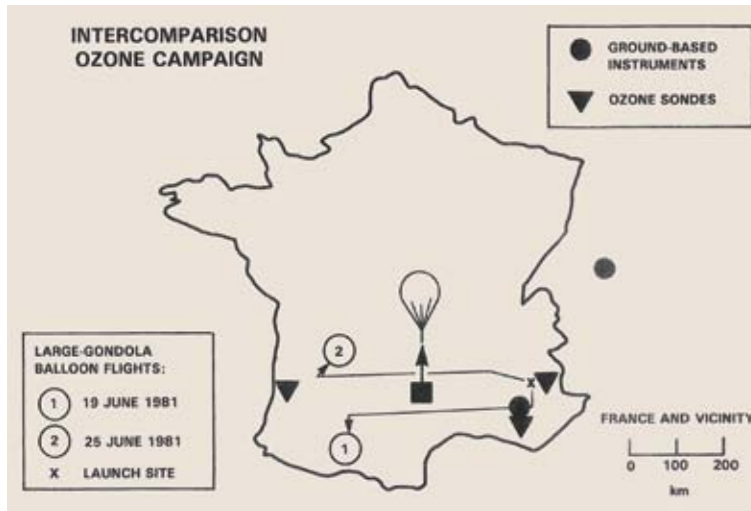

Locations of the various instruments and balloon trajectory during the ozone intercomparison campaign in 1981.

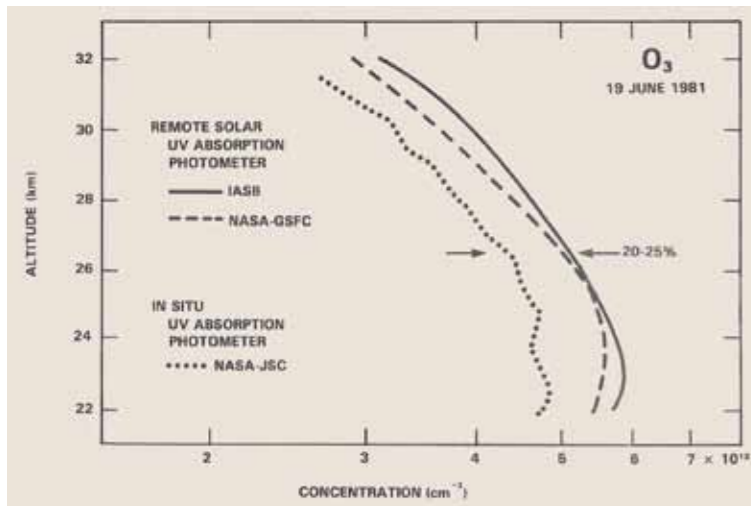

Comparison of ozone observation by UV absorption remote sensing.

Overview paper
Pommereau, J.-P. (2011), La physico-chimie de l'atmosphère, in Les ballons au service de la recherche: l'aérostation scientifique des origines à nos jours, edited by Lebeau, A. and J.-P. Sanfourche, pp. 232-249, Editions Edite & Institut Français de l'Histoire de l'Espace, Paris.

Intercomparison ozone campaign, Gap-Tallard, France, June 1981, coordinated by Marie-Lise Chanin
Chanin, M.L. (1983), The intercomparison ozone campaign held in France in June 1981: Description of the campaign, *Planetary and Space Science*, 31 (7), 707-725, doi:10.1016/0032-0633(83)90116-2.

MAP/GLOBUS 1983 campaign, Aire sur l'Adour, France, coordinated by Dirk Offermann
Offermann, D. (1987), The MAP/GLOBUS campaign 1983: Introduction, *Planetary and Space Science*, 35(5), 515-625, doi:10.1016/0032-0633(87)90119-X.

MAP/GLOBUS 1985 campaign, Aire sur l'Adour, France, coordinated by Jean-Pierre Pommereau
Robbins, D., P. Aïmedieu, F. Goutail, J. Pelon, J.-P. Pommereau, N. Iwagami, T. Ogawa, M. Koike, K. Shibasaki, P. Marché, J. P. Naudet, P. Rigaud, D. Huguenin, J. Lenoble, G. Maddrea Jr. and M. P. McCormick (1989), Stratospheric ozone measurements from the 1985 MAP/GLOBUS NO_x campaign, *Journal of Geophysical Research: Atmospheres*, 94(D8), 11074-11087, doi:10.1029/JD094iD08p11074.

cycles. In addition, new comparisons between in situ and remote-sensing observations provided information on the performance of the sensors. A series of 3 flights carrying the same instruments were launched sequentially during a full 24 h period, the first between evening and early morning, the second between late night and afternoon, and the third between morning and midnight. In addition, two of them performed balloon controlled altitude excursions for measuring profiles concentrations.

Balloon Intercomparison Campaign, BIC

Robbins, D., J. Waters, P. Zimmermann, R. Jarnot, J. Hardy, H. Pickett, S. Pollitt, W. Traub, K. Chance, N. Louisnard, W. Evans and J. Kerr (1990), Ozone measurements from the Balloon Intercomparison Campaign, *Journal of Atmospheric Chemistry*, 10(2), 181-218, doi:10.1007/BF00054856.

Roscoe, H. K., B. J. Kerridge, S. Pollitt, N. Louisnard, J. M. Flaud, C. Camy-Peyret, C. Alamichel, J.-P. Pommereau, T. Ogawa, N. Iwagami, M. T. Coffey, W. Mankin, W. F. J. Evans, C. T. McElroy and J. Kerr (1990), Intercomparison of remote measurements of stratospheric NO and NO₂, *Journal of Atmospheric Chemistry*, 10(2), 111-144, doi:10.1007/BF00054853.

Balloon Ozone Intercomparison Campaign, BOIC

Hilsenrath, E., J. Ainsworth, A. Holland, J. Mentall, A. Torres, W. Attmanspacher, A. Bass, W. Evans, W. Komhyr, K. Mauersberger, A. J. Miller, M. Proffitt, D. Robbins, S. Taylor and E. Weinstock (1985), Results from the Balloon Ozone Intercomparison Campaign (BOIC), in *Atmospheric Ozone: Proceedings of the Quadrennial Ozone Symposium held in Halkidiki, Greece 3-7 September 1984*, Springer, Dordrecht.

Hilsenrath, E., W. Attmanspacher, A. Bass, W. Evans, R. Hagemeyer, R. A. Barnes, W. Komhyr, K. Mauersberger, J. Mentall, M. Proffitt, D. Robbins, S. Taylor, A. Torres and E. Weinstock (1986), Results from the balloon ozone intercomparison campaign (BOIC), *Journal of Geophysical Research: Atmospheres*, 91(D12), 13137-13152, doi:10.1029/JD091iD12p13137.

Overall, the MAP/GLOBUS campaigns resulted in a better understanding of NO_x photochemical cycles (NO, NO₂ and NO₃), and allowed improving the retrievals of the two first NO₂ measuring satellites instruments, the NASA Stratospheric Aerosol and Gas Experiment (SAGE II) and Solar Mesospheric Experiment (SME), as well as the ozone profile retrievals of the SBUV instrument on board the NASA Nimbus-7 satellite.

BIRA-IASB was strongly involved in those measurements, performing in addition positive and negative ions measurements with cryogenic mass spectrometers, developed in the laboratory, with which acetonitrile mixing ratios were derived from positive ion spectra, showing large deviation compared to reference profiles of up to a factor of 2 around 30 km altitude. In both campaigns, solar occultation measurements in ultraviolet and visible ranges were also performed by means of spectrometers developed at BIRA-IASB, providing reliable ozone and nitrogen dioxide profiles as well as ozone from ultraviolet absorption measurement by means of a filter radiometer already aforementioned.

Selected References

Aimedieu, P., A. J. Krueger, D. E. Robbins and P. C. Simon (1983), Ozone profile intercomparison based on simultaneous observations between 20 and 40 km, *Planetary and Space Science*, 31(7), 801-807, doi:10.1016/0032-0633(83)90131-9.

Ingels, J., D. Nevejans, P. Frederick and E. Arijs (1987), Acetonitrile and sulfuric acid concentrations derived from ion composition measurements during the MAP/GLOBUS 1983 campaign, *Planetary and Space Science*, 35(5), 685-691, doi:10.1016/0032-0633(87)90135-8.

Offermann, D., H. Rippel, P. Aimedieu, W. A. Matthews, G. Mégie, E. Arijs, J. Ingels, D. Nevejans, W. Attmanspacher, J. M. Cisneros, A. W. Dawkins, D. Demuer, P. Fabian, F. Karcher, G. Froment, U. Langematz, R. Reiter, K. W. Rothe, U. Schmidt and R. J. Thomas (1987), Disturbance of stratospheric trace gas mixing ratios during the MAP/GLOBUS 1983 campaign, *Planetary and Space Science*, 35(5), 673-684, doi:10.1016/0032-0633(87)90134-6.

Pommereau, J. P., P. Fabian, G. Flentje, M. Helten, H. W. Pätz, F. Karcher, G. Froment, G. Armand, W. A. Matthews, D. Offermann, H. Rippel, P. Rigaud, J. P. Naudet, D. Huguenin, P. C. Simon, W. Peetermans, P. Vandeneede, R. Zander and G. Roland (1987), Intercomparison of stratospheric NO₂ and NO₃ measurements during MAP/GLOBUS 1983, *Planetary and Space Science*, 35(5), 615-629, doi:10.1016/0032-0633(87)90128-0.

Roeland, S., C. Lippens and P. C. Simon (1983), Stratospheric ozone measurements by solar ultraviolet absorption, *Planetary and Space Science*, 31(7), 767-772, doi:10.1016/0032-0633(83)90126-5.

Simon, P. C., W. Peetermans, E. Plateau, P. Rigaud, J.-P. Naudet, D. Huguenin, D. Offerman and H. Rippel (1987), Remote sensing ozone measurements from stratospheric balloon during the MAP/GLOBUS campaign 1983, *Planetary and Space Science*, 35(5), 595-601, doi:10.1016/0032-0633(87)90125-5.

MASS SPECTROMETRY

Crist Amelinck and Niels Schoon

Starting in the mid-seventies, the mass spectrometry group of BIRA-IASB, led by Etienne Arijs, has carried out *in situ* measurements in the stratosphere with balloon-borne mass spectrometers for almost 25 years. This research has strongly contributed to the present knowledge of the stratospheric natural ion chemistry and composition and resulted in concentration profiles of important neutral trace constituents in this part of the Earth's atmosphere.

Determination of the Natural Stratospheric Ion Composition: A Challenging Problem.

Because of the importance of the ionosphere (> 65 km) for long-range radio wave propagation, the natural ion composition in the lower part of that region of the atmosphere (D-region), obtained using sounding rockets, was already known for some time by the mid-seventies. Those experiments, together with theoretical D-region models, led to predictions of the ion composition of the lower lying stratosphere, but *in situ* measurements in the stratosphere had not yet been performed.

Ion composition measurements in the stratosphere formed a real challenge and only the BIRA-IASB group and a German group (Frank Arnold and co-workers, MPIK, Heidelberg) were successful in performing these measurements. A very sensitive instrument was required because of the low ion number densities in the stratosphere (only a few thousand ion pairs per cm³). Furthermore, ions had to be sampled from a relatively low pressure environment (a few hPa) into a mass spectrometer, which itself had to be operated at high vacuum. Because of power restrictions accompanying balloon experiments, mechanical pumping systems could not be used for this purpose. Therefore, a new instrument was developed at the Institute, mainly consisting of a quadrupole mass spectrometer built into a high speed cryopump. The cryopump was suspended on a large aluminum flange on which was bolted a hermetically sealed and pressurised aluminum container, housing all power supplies as well as the electronics control hardware. Instrument control and transmission of acquired data was performed via a real-time telemetry infrastructure. The entire instrument was integrated in an aluminum shock absorbing support structure in order to reduce damage during the landing phase.

Numerous launches of this instrument by stratospheric balloons, operated by the Balloon Division of the Centre National d'Etudes Spatiales (CNES), took place from Gap-Tallard and Aire-sur-l'Adour in France (see previous Section). Measurements were carried out between 20 and 45 km altitude (the upper limit was reached with an open stratospheric balloon with a volume of 1 000 000 m³).



Ion mass spectrometer in the laboratory.

Quadrupole mass spectrometer

The quadrupole mass spectrometer is an arrangement in which ions with a desired mass-to-charge ratio are made to describe a stable path under the effect of a static and a high-frequency electric quadrupole field, and are then detected. Ions with a different mass/charge are separated from the detected ions because of their unstable paths.

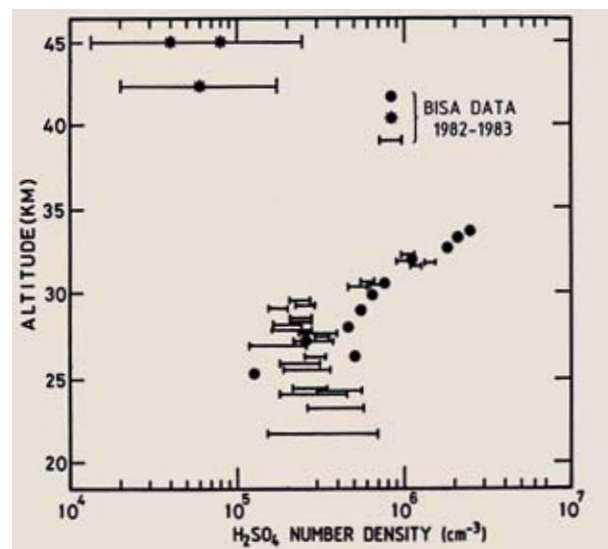

Sulfuric acid number densities versus altitude as derived from different balloon flights. (adapted from Arijis et al., 1983)

Identification of Positive and Negative Ion Families in The Stratosphere and Derivation of Vertical Profiles of Stratospheric Trace Gas Concentrations from Natural Ion Composition Measurements

In the stratosphere, ions are produced by galactic cosmic radiation, which is a non-selective source of ionization mainly resulting in the formation of electrons, N_2^+ and O_2^+ ions. As the electrons rapidly attach to oxygen molecules forming O_2^- ions, a positive ion/negative ion rarefied plasma is readily formed. Since the ions can survive for a few hours before being lost by recombination with ions of opposite charge, they undergo many reactions with stratospheric trace gases, finally resulting in stable terminal ion species.

Stratospheric positive ion spectra showed the presence of two main families of positive ion species: $H^+(H_2O)_n$ (proton hydrates) and $H^+X(H_2O)_m$ (non-proton hydrates). High resolution mass spectra obtained by the BIRA-IASB group allowed the first unambiguous determination of the mass and of vertical concentration profiles of the unknown compound X (41 atomic mass units) which is now generally accepted to be acetonitrile (CH_3CN), known surface sources of which are biomass burning, direct releases from industry and traffic exhaust.

Negative ion spectra also showed the presence of two main negative ion families: $NO_3^-(HNO_3)_n$ and $HSO_4^-(H_2SO_4)(HNO_3)_m$. The members of the former family are converted to members of the latter family by ion/molecule reactions with gaseous sulfuric acid (H_2SO_4). As was the case for CH_3CN , available experimental data allowed the derivation of stratospheric H_2SO_4 concentration profiles from the ion abundances in the negative mass spectra. This was a major scientific achievement, given the importance of this compound as a major constituent of stratospheric aerosols.

From Passive to Active Chemical Ionization Mass Spectrometry

Nitric acid is an important reservoir gas in the stratosphere which is involved in ozone depletion at polar and mid-latitudes. Accurate *in situ* concentration measurements of this trace compound and some others in the stratosphere can be obtained by coupling a flow tube reactor to a balloon-borne mass spectrometer. In this method stratospheric air is pumped through the reactor and well-chosen, artificially produced reactant ions are introduced into the reactor at a fixed distance upstream of the sampling orifice of the mass spectrometer. When being transported by the air flow, these reactant ions then selectively react with some of the trace gases which are present in the air flow, resulting in the formation of specific product ions. Absolute concentrations of those trace gases can then be determined from the product and reactant ion abundances in the mass spectra, the experimentally determined reaction time and the rate constants and the product ion distributions of the reactions between the reactant ions and the trace gases.

In a close collaboration with the *Physikalisches Institut* of the *Universität Bern* (group of Prof. Ernest Kopp) and the *Laboratoire de Physique et Chimie de l'Environnement* of the University of Orléans (group of Prof. André Barassin), a new field instrument was built at the Institute incorporating a double focusing Mattauch-Herzog magnetic mass spectrometer and an octopole ion guide. The aim of the new instrument, called MACSIMS (Measurement of Atmospheric Constituents by Simultaneous Ion Mass Spectrometry), was to perform simultaneous measurements of stratospheric NO_y compounds by using highly selective reactant ions such as CO_3^- , Cl_3^- and CF_3O^- . Several balloon flights of the MACSIMS instrument were carried out in the 1990s from the CNES launch sites in France and from the CNES/INTA base near Leon in Northern Spain. The *in situ* measurements clearly demonstrated the applicability of different selective reaction schemes to derive accurate stratospheric HNO_3 concentration profiles. These balloon experiments clearly contributed to pave the way for field applications of chemical ionization mass spectrometry (CIMS), a technique which is now regularly used in atmospheric research worldwide.

Throughout the complete history of balloon-borne mass spectrometry at the Institute, the engineering department has strongly supported the development of the different instruments. Besides the magnetic mass spectrometer, that was delivered by the University of Bern, BIRA-IASB conceived the full control electronics, ranging from the central microprocessor, over the steering of every valve and meter, up to the communication section with CNES' on board telecommand and telemetry equipment. The implication of the mechanical workshop of the Institute was equally important. They designed and manufactured all the mechanical hardware from the shock absorbing gondola structures to boxes in which the electronics were lodged. Finally the engineering department was responsible for a user friendly ground support system allowing to command the instruments in real time during flight and to monitor on the fly the data transmitted from the balloon.

Selected References

Arijis, E., D. Nevejans and J. Ingels (1980), Unambiguous mass determination of major stratospheric positive ions, *Nature*, 288, 684-686, doi:10.1038/288684a0.

Arijis, E., D. Nevejans, J. Ingels and P. Frederick (1983), Negative ion composition and sulfuric acid vapour in the upper stratosphere, *Planetary and Space Science*, 31(12), 1459-1464, doi:10.1016/0032-0633(83)90019-3.

Arijis, E., D. Nevejans, J. Ingels and P. Frederick (1985), Recent stratospheric negative ion composition measurements between 22- and 45-km altitude, *Journal of Geophysical Research: Atmospheres*, 90(D4), 5891-5896, doi:10.1029/JD090iD04p05891.

Arijis, E., A. Barassin, E. Kopp, C. Amelynck, V. Catoire, H. P. Fink, C. Guimbaud, U. Jenzer, D. Labonnette, W. Luthardt, E. Neefs, D. Nevejans, N. Schoon and A.-M. Van Bavel (1998), Stratospheric chemical ionization mass spectrometry: nitric acid detection by different ion-molecule reaction schemes, *International Journal of Mass Spectrometry*, 181(1-3), 99-111, doi:10.1016/S1387-3806(98)14162-3.

Double focusing magnetic mass spectrometer

The double focusing magnetic mass spectrometer is a mass spectrometer which uses both direction and velocity focusing, and therefore an ion beam of a given mass/charge is brought to a focus where the ion beam is initially diverging and contains ions of the same mass and charge with different translational energies. Separation of the ion beam according to mass/charge values is accomplished by the action of a permanent magnetic field on the trajectories of the charged particles.



Ion mass spectrometer gondola during integration.



Ion mass spectrometer gondola during carried to the site at the CNES/INTA base near in León. (Northern Spain)



Release of the MACSIMS instrument from the CNES stratospheric balloon launch site at Aire-sur-l'Adour (France) in October 1998.



BEELGISCH INSTITUUT VOOR RUIMTE-AERONOMIE (BIRA) IN STITUT D'AERONOMIE SPATIALE DE BELGIQUE (IASB) BELGIAN INSTITUTE FOR SPACE AERONOMY (BIRA-IASB) BELGISCH INSTITUUT VOOR RUIMTE-AERONOMIE (BIRA) INSTITUT D'AERONOMIE SPATIALE DE BELGIQUE (IASB)

FIRST ORBITAL OBSERVATIONS

Paul C. Simon



Sunset view from shuttle. (credit: NASA)

SPACELAB I AND ATLAS MISSIONS

Paul C. Simon

After landing on the Moon in 1969, NASA set up a programme to modify the Apollo hardware for scientific missions, leading to the US first space station Skylab which was in operation from 1973 to 1979. The Space Shuttle programme, approved at the same time, was supposed to refurbish Skylab, but did not succeed because of delays in its development. Post-Skylab NASA space laboratory projects included Spacelab (in collaboration with ESA), and Space Station Freedom, the precursor of the International Space Station (ISS).

The Space Transportation System (STS) programme was initiated in 1969 by the US National Aeronautics and Space Administration (NASA). STS is the official name of the Space Shuttle. It was the only new orbital spacecraft planned at that time, no other new US launchers were foreseen. In Europe, the Ariane programme was initiated in 1973 by ESA with a significant commercial success. To reduce the cost of space exploration, the STS was conceived to be partially reused, a feature which made the Space Shuttle unique among spacecraft, as most rockets are usually only used once.

The Space Shuttle has three main parts: a reusable orbital vehicle, two reusable solid rocket boosters and an external fuel tank of liquid nitrogen and oxygen, lost after launch. The orbiter has a large capacity cargo bay which enabled the orbiter to carry payloads for orbital operations (experiments and/or satellite repair), launches of military, operational and scientific satellites, and space construction like the future ISS.

Once arrived in its low Earth orbit, the Shuttle usually flew at an altitude of 320 kilometres above sea level. The basic mission duration is 7 days in space, with a crew of up to eight astronauts. The crew controls the deorbiting manoeuvres and the re-entry into the atmosphere and its landing is like an aircraft glider. It is then refurbished for the next mission with a turnover up to once a month as defined in the definition phase of the project.

The European Spacelab programme was formally adopted in 1973 during the European Space Conference in Brussels. Spacelab was a large modular and reusable laboratory, designed by ESA, which fitted into the cargo bay of the Space Shuttle. Spacelab consists in a suite of different components: pressurised modules where the crew can work in “short sleeves”, unpressurised platforms (“pallets”) exposed to space environment, and other hardware e.g. to launch satellite or to make laboratory experiments specific for each mission. Each component can be assembled in different configuration, depending of the mission objectives.

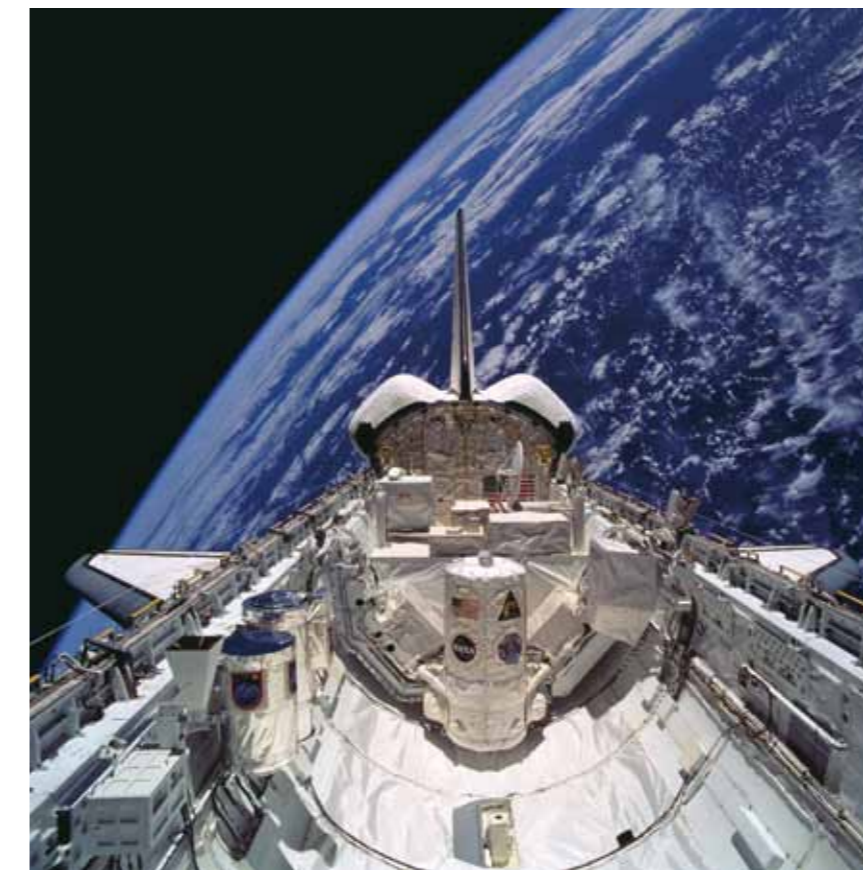

Shuttle cargo bay with the ATLAS-3 payload. (credit: NASA)



The Spacelab 1 logo, designed by Cyr Frimout, the brother of Dirk Frimout. Dirk Frimout was an ESA operation engineer and responsible for the ESA science training of the Spacelab 1 crew.



ATLAS 1 logo

The first full mission was Spacelab 1 (STS-9), launched on November 28, 1983 for a duration of 10 days, 7 hours and 47 minutes, with for the first time six crew members. The landing took place on December 8, 1983. It was a joint ESA/NASA mission, with a large variety of experiments. Altogether 73 separate investigations were carried out in astronomy and physics, atmospheric physics, Earth observations, life sciences, materials sciences, space plasma physics and technology. Among them, three experiments were performed by BIRA-IASB scientists and engineers, in collaboration with other laboratories: Grille Spectrometer, Solar Spectrum (SOLSPEC), and ALAE, the investigation of Atmospheric Hydrogen and Deuterium through measurement of Lyman-Alpha emission (see next sections). A re-fly was rapidly decided and scheduled in 1986. Unfortunately, the Space Shuttle Challenger disaster on January 28, 1986 suspended the STS launches until 1988.

In the meantime, the ATLAS (Atmospheric Laboratory for Applications and Science) programme, pertaining to the "Mission to Planet Earth" was defined, with a series of Spacelab flights to study the Earth's atmosphere and the Sun's influence upon it over one solar cycle, which lasted 11 years. While nine ATLAS missions were originally planned, only three flights were actually carried out, with launches on March 24, 1992, on April 8, 1993 and on November 3, 1994. Despite its successes, the series was interrupted for budgetary reasons. The Viscount Dirk Frimout was selected as a payload specialist for the ATLAS 1 mission.



Sunrise observed through the pressurized module of Spacelab.

THE GRILLE SPECTROMETER

Christian Muller

At the beginning of the Spacelab programme, scientists were informed that the Spacelab payload would have a two weeks turnover comparable with an aircraft and operate experiments from a pressurised module. ESA planned on one test flight, four demonstration flights and 20 operational flights. Unfortunately, the ESA council had to reduce its ambition and in the end, all the ESA science experiments selected for the demonstration flights were grouped on the first test flight, together with an equal number of NASA experiments and a few Japanese instruments.

The Grille Spectrometer which had been so successful on balloons (see chapter 6) and airplanes was selected for the Spacelab 1 mission, as an "external" payload on the "pallet". It was designed by two organizations: the Office National d'Études et de Recherches Aéropatiales (ONERA) in France and BIRA-IASB.

The main scientific objective of the Grille Spectrometer was to obtain the vertical distributions of ten molecules relevant to the ozone chemistry at latitudes different from the ones which had been covered by balloon flights. Measurements of atmospheric trace gases have been performed during the 10 day mission of Spacelab 1 from November 28 to December 8, 1983. Observations have been performed for the first time through the whole middle atmosphere over a wide range of latitude and seasons, for a set of trace constituents of basic importance to the knowledge of photochemistry and transport processes occurring in the middle atmosphere. The results cover the entire spectral range related to NO, NO₂, CH₄, N₂O, CO, CO₂, O₃, HCl, HF and H₂O.

A second objective was to test the feasibility of extending these observations to the upper stratosphere, mesosphere and higher in order to understand the chemistry of these regions and in particular to constrain the models describing the oxidation of methane and its transport. This second objective was fully successful, in part due to the specific conditions of the flight, the mesosphere being particularly active during the Southern summer solstice.

The Grille Spectrometer took advantage of the favourable timeline and of the extra day in orbit to perform more than 65 successful solar occultation runs during its re-fly on the ATLAS 1 mission. It succeeded in obtaining spectra pertinent to its ten target molecules from the upper troposphere to the lower thermosphere. New information on HCl vertical profiles was obtained, for assessing long-term trends of this important stratospheric species.

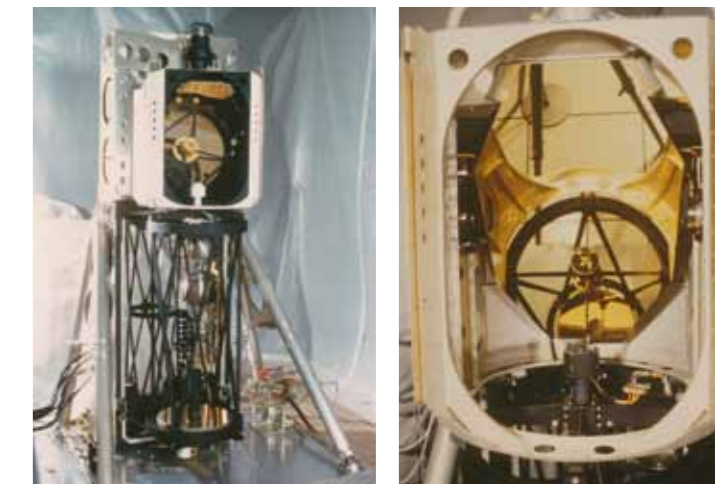

The grille infrared spectrometer

Detail of the front optics of the grille infrared spectrometer

Vertical concentration profiles of the ten molecules relevant to the ozone chemistry as measured by the Grille Spectrometer during the Spacelab 1 mission. Red curves indicate those species which were measured for the first time during this mission. (Credit: NASA)

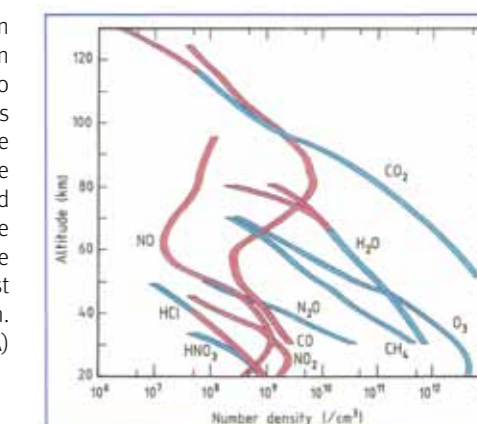

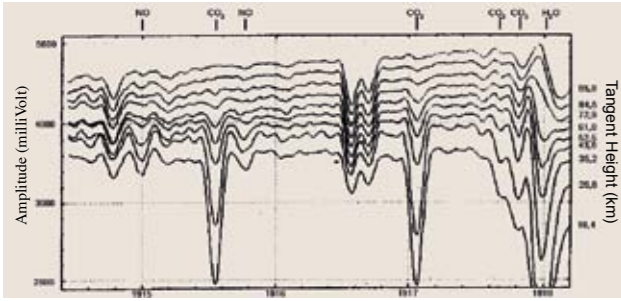

Example of spectra of nitric oxide obtained during the Spacelab 1 flight. Nitric oxide was observed very high due to the particular geometry of this late November flight. The High Southern part of the globe was almost continuously lit and simultaneous electron precipitations even enhanced the NO production.



Spacelab 1 team in Houston, Texas.

The Grille Spectrometer was a large instrument, which enabled to be manipulated manually during tests, moving the pointing mirror, grating and filter wheel with gloves. When the pointer was opened, its moves could be seen as well as heard. The instrument was, at that time, already controlled by an “Electrical Ground Support Equipment” (EGSE), which was in fact a “mini-computer” generating commands and recording and displaying the data. It was already possible to display quick-looks on computer screens. The programming of this EGSE was a combination of a proprietary HP operating system, Fortran and Assembler. During tests, this EGSE was also used as instrument monitor, but in the NASA environment, all technological data and flight commands were on flight systems provided by NASA. The instrument was fully programmable: it had also pre-programmed sequences burnt both in permanent memories and in a “Mass Memory Unit” which could be uploaded during flight.

During flight, the instrument was operated on a 24h basis with two shifts of the ground teams. The ground team itself was divided in an off-line and an online team which received both ESA and NASA support.

In conclusion, the Spacelab grille programme had demonstrated the possibility to probe the global atmosphere from the upper troposphere to the thermosphere using a space-borne instrument. It was the precursor of the current Earth observation system.

Selected References

De Maziere, M., C. Muller, C. Lippens, J. Vercheval, D. Fonteyn, R. Armante, C. Camy-Peyret, V. Achard, J. Besson, J. Marcault, D. Henry, N. Papineau, J. P. Meyer and D. Frimout (1993), Second flight of the Spacelab Grille Spectrometer during the ATLAS-1 mission, *Geophysical Research Letters*, 20(6), 503-506, doi:10.1029/93GL00082.

Girard, A., J. Besson, D. Brard, J. Laurent, M. P. Lemaître, C. Lippens, C. Muller, J. Vercheval and M. Ackerman (1988), Global Results of Grille Spectrometer Experiment On board Spacelab 1, *Planetary and Space Science*, 36(3), 291-300, doi:10.1016/0032-0633(88)90136-5.

Laurent, J., M. P. Lemaître, J. Besson, A. Girard, C. Lippens, C. Muller, J. Vercheval and M. Ackerman (1985), Middle atmospheric NO and NO₂ observed by the Spacelab grille spectrometer, *Nature* 315, 126-127, doi:10.1038/315126a0.

Laurent, J., D. Brard, A. Girard, C. Camy-Peyret, C. Lippens, C. Muller, J. Vercheval and M. Ackerman (1986), Middle atmospheric water vapor observed by the Spacelab One grille spectrometer, *Planetary and Space Science*, 34(11), 1067-1071, doi:10.1016/0032-0633(86)90017-6.

Lemaître, M. P., J. Laurent, J. Besson, A. Girard, C. Muller, C. Lippens, J. Vercheval and M. Ackerman (1984), A sample performance of the grille spectrometer on board Spacelab 1, *Science* 225, 171, doi:10.1126/science.225.4658.171.

Muller, C., C. Lippens, J. Vercheval, M. Ackerman, J. Laurent, M. P. Lemaître, J. Besson and A. Girard (1985), Grille spectrometer experiment on first Spacelab payload, *Journal of Optics*, 16(4), 155, doi:10.1088/0150-536X/16/4/001.

Muller, C., J. Vercheval, M. Ackerman, C. Lippens, J. Laurent, M. P. Lemaître, J. Besson and A. Girard (1985), Observations of middle atmospheric CH₄ and N₂O vertical distributions by the Spacelab 1 Grille Spectrometer, *Geophysical Research Letters*, 12(10), 667-670, doi:10.1029/GL012i010p00667.

Vercheval, J., C. Lippens, C. Muller, M. Ackerman and M.-P. Lemaître (1986), CO₂ and CO vertical distribution in the middle atmosphere and lower thermosphere deduced from infrared spectra, *Annales Geophysicae - Series A, Upper atmosphere and space sciences*, 4, 161-164.

THE SOLAR SPECTRUM EXPERIMENT

Paul C. Simon and Didier Gillotay

The solar electromagnetic radiation is the primary source of energy for the terrestrial environment. The largest fraction of energy associated with the solar spectrum is situated in the visible. The ultraviolet domain for wavelengths shorter than 320 nm represents only a small fraction (2%) of the total incident flux. This spectral range is of fundamental importance for aeronomic processes taking place in the troposphere, the middle atmosphere and the thermosphere.

Because of the complexity of the atmospheric processes and the strong interplay and feedback between transport, chemical composition and radiative budget, atmospheric and climate studies should include observations of the spectral solar radiation and its variability, in close relation with the atmospheric constituents which control the penetration of solar radiation. The ozone molecule is a key minor constituent for the stratosphere. It is produced by photodissociation of molecular oxygen by solar radiation of wavelengths shorter than 242 nm. It provides the main heat source through the absorption of solar ultraviolet radiation and thus determines to a great extent the temperature profile in the stratosphere and the general circulation. Ozone therefore couples the stratosphere and the tropospheric climate through complex processes involving radiative, chemical and dynamic effects.

Consequently, the knowledge of solar spectral irradiance values as well as their temporal variations is fundamental in studying the chemical, dynamical and radiative processes in the atmosphere. In addition, the study of solar variability is of crucial importance to distinguish between its impacts on the terrestrial environment in comparison with anthropogenic perturbations.

The ultraviolet range of the solar electromagnetic spectrum is characterized by temporal variations which directly affect the Earth's atmosphere. Two time scales are generally considered in relation to atmospheric studies: the 11-year activity cycle and the 27-day rotation period of the Sun (see chapter 3). Only the decadal time scale can be related to climate changes.

The “Solar Spectrum” (SOLSPEC) project purposes were to measure the absolute solar irradiance in the wavelength range from 200 to 2400 nm and its temporal variations with uncertainties of 2% in UV, 1% in the visible and 3% in the infrared range. The required accuracy and precision in the measurements was achieved by means of pre- and post-flight calibrations and an onboard calibration device.

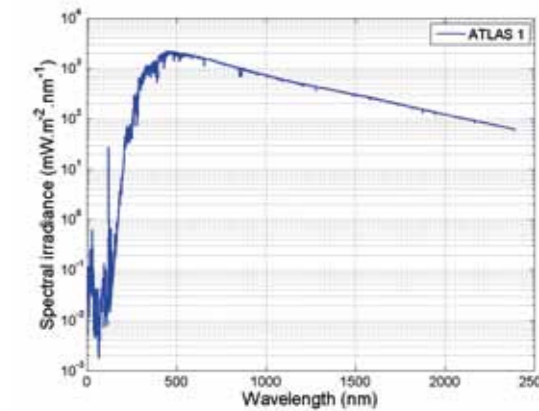

The composite ATLAS 1 spectrum, using rocket data from 0.5 nm to Lyman-alpha, UARS (SUSIM and SOLSTICE) data from Lyman-alpha to 200 nm, ATLAS-SSBUV, SOLSTICE and SOLSPEC from 200 to 400 nm and SOLSPEC above 400 nm.

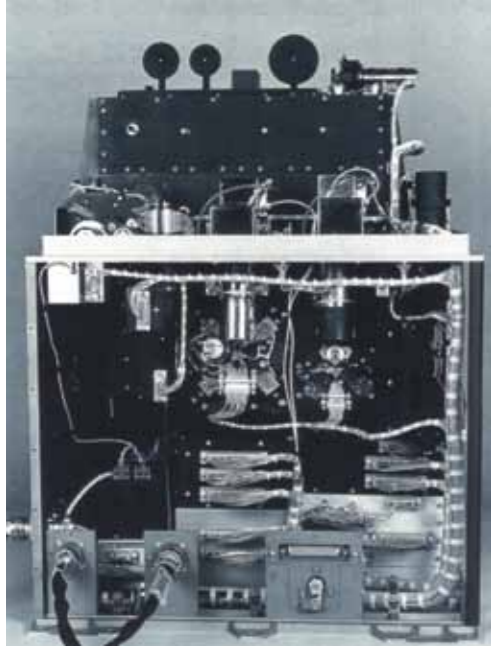

Its concept has been defined at the end of the seventies, based upon the collaboration between BIRA-IASB, the “Service d’Aéronomie” (now LATMOS) of the “Centre National de la Recherche Scientifique” (CNRS, France), the “Landessternwarte Königstuhl” (Heidelberg, Germany) and the “Hamburger Sternwarte” (Hamburg-Bergedorf, Germany).

The instrument consisted of three double grating spectrometers covering the ultraviolet (from 200 to 370 nm), visible (from 350 to 900 nm) and infrared (from 800 to 2400 nm) wavelength ranges and an onboard calibration device. The spectrometers use holographic gratings of 10-cm focal length mounted on the same mechanical shaft which rotates with a precision of 2 arcsec.

The onboard calibration device consists of two deuterium lamps, two tungsten ribbon lamps, and one hollow cathode lamp. The deuterium and tungsten ribbon lamps are used to monitor changes of the instrument response either on the ground or in space. The hollow cathode lamp permits a determination of the instrument wavelength scale and band passes of the spectrometers. The instrument was calibrated against a black body at 3300 K in Heidelberg. A set of stable tungsten and deuterium lamps was used as transfer standards.

The SOLSPEC instrument flew for the first time during the ESA/NASA Spacelab 1 mission, on board the Columbia space shuttle (STS-09 mission). The Sun pointing was performed by the shuttle itself. Scientific data were stored and displayed directly on the instrument ground support equipment and controlled in real time by the SOLSPEC team, at Johnson Space Flight Centre, in Houston. At the end of the mission, after retrieval, the instrument was again re-calibrated.

The ATLAS missions, on board NASA space shuttles, were part of the NASA’s “Mission to Planet Earth”, and SOLSPEC was selected to re-fly during this series of missions, with the purpose to quantify the long term (11-year) variation of Sun irradiance. Ideally several flights separated by 12 to 18 months over several solar cycles were needed.

ATLAS 1 experiments focused on four scientific disciplines: atmospheric science, solar science, space plasma physics and astronomy. This programme was closely related to the NASA’s Upper Atmosphere Research Satellite (UARS), launched from the Space Shuttle in September 1991 and including two other solar spectroradiometers.

SOLSPEC was jointly operated by the NASA Payload Operation Control Centre at the Marshall Space Flight Centre (Huntsville, Alabama) and by the scientific team in the Space Remote Operation Centre in Uccle (see chapter 16).

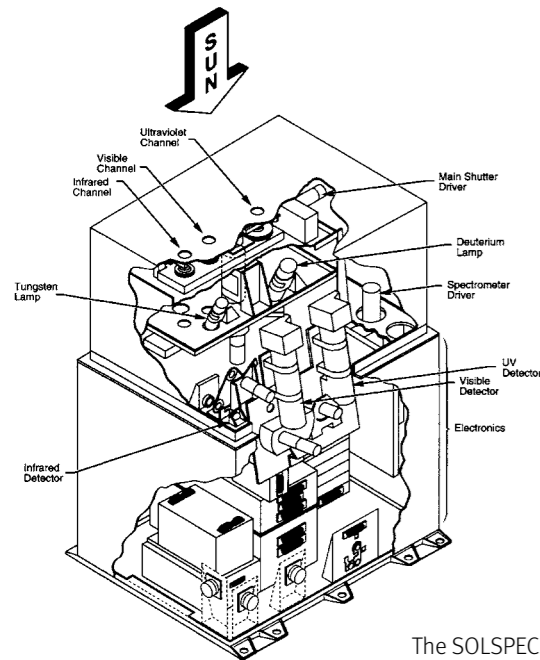

The SOLSPEC instrument.

Selected References

Cebula, R. P., G. O.Thuillier, M. E.VanHoosier, E. Hilsenrath, M. Herse, G. E. Brueckner and P.C. Simon (1996), Observations of the solar irradiance in the 200–350 nm interval during the ATLAS-1 Mission: A comparison among three sets of measurements-SSBUV, SOLSPEC, and SUSIM, *Geophysical Research Letters*, 23(17), 2289-2292, doi:10.1029/96GL01109.

Mandel, H., D. Labs, G.Thuillier, M. Hersé, P.C. Simon and D. Gillotay (1998), Calibration of the SOLSPEC spectrometer to measure the solar irradiance from space, *Metrologia*, 35(4), 697-700, doi:10.1088/0026-1394/35/4/80.

Thuillier, G., P.C. Simon, D. Labs, R. Pastiels and H. Neckel,(1981), An instrument to measure the solar spectrum from 170 to 3200 nm on board Spacelab, *Solar Physics*, 74(2), 531-537, doi:10.1007/BF00154536.

Thuillier, G., M. Hersé, P.C. Simon, D. Labs, H. Mandel and D. Gillotay (1997), Observation of the UV solar spectral irradiance between 200 and 350 nm during the ATLAS 1 mission by the SOLSPEC spectrometer, *Solar Physics*, 171(2), 283-302, doi:10.1023/A:1004930219506.

Thuillier, G., M. Hersé, P.C. Simon, D. Labs, H. Mandel, D. Gillotay and T. Foujols (1998), The Visible Solar Spectral Irradiance from 350 to 850 nm As Measured by the SOLSPEC Spectrometer During the ATLAS 1 Mission, *Solar Physics*, 177(1-2), 41-61, 1998, doi:10.1023/A:1004953215589.



Rollout of STS-45 with the ATLAS 1 payload. (credit: NASA)



Part of the SOLSPEC team with Dirk Frimout in the instrument control room in Houston, during the Spacelab 1 flight in 1983.

Mission to Planet Earth

The awareness of the environment of the Earth and of the sun radiation level and spectrum is of importance to both Earth-based and space-borne systems as well as to advanced studies on climate. Monitoring the Sun radiation outside of the Earth atmosphere over a large electromagnetic spectrum and correlating with parallel observations with other space missions and on ground helps provide the accurate data required to support predictive models and anticipate on the influence of Sun radiation on our environment.

INVESTIGATION OF ATMOSPHERIC HYDROGEN AND DEUTERIUM THROUGH MEASUREMENT OF LYMAN-ALPHA EMISSION

Paul C. Simon

The experiment “Atmospheric hydrogen and deuterium through measurement of Lyman-Alpha Emission” (ALAE), has measured for the first time, the distribution of atomic deuterium (heavy hydrogen) in the upper atmosphere in order to provide a better understanding of atmospheric processes. When Earth water evaporates into the atmosphere, ultraviolet solar radiation breaks down the water vapour into hydrogen and deuterium atoms, as well as oxygen atoms. The hydrogen atoms rise higher than the heavier deuterium. The hydrogen and deuterium are therefore physically separated. ALAE also detected the glow of hydrogen atoms and free protons (hydrogen nuclei) in the corona of hydrogen gas that envelops Earth. Deuterium relative abundance compared to hydrogen is an indication of atmospheric turbulence in the lower thermosphere. After determining the hydrogen/deuterium ratio, the rate of water evolution in Earth’s atmosphere can be better studied.

ALAE was developed at BIRA-IASB in collaboration with “Le Service d’Aéronomie” of “Centre National de Recherches Spatiales” (CNRS, France; now LATMOS). The entire mechanics was made in the BIRA-IASB workshop and important theoretical studies were carried out by Gaston Kockarts.

ALAE measured the extreme ultraviolet radiation of hydrogen and deuterium at 121 nm, the wavelength of the Lyman-alpha emissions lines. These two hydrogen isotopes radiate at slightly different wavelengths. The comparative strength of these emissions indicates the ratio of hydrogen to deuterium atoms and how the gases mix in the upper atmosphere enabling the hydrogen/deuterium ratio determination.

A spectrophotometer associated with two absorption cells, one filled with hydrogen and the other with deuterium, was used in studying various sources of Lyman-alpha emission in the atmosphere, in the interplanetary medium, and possibly in the galactic medium. Lyman-alpha emission is also possibly present in auroral zones, equatorial zones, and at the foot of the polar cusp, where the solar wind interacts directly with the neutral atmosphere.

ALAE flew twice, once during the Spacelab I mission in 1983 and once during the ATLAS I mission in 1992, collecting measurements of hydrogen and deuterium atoms, from the mesosphere, the thermosphere, the exosphere and the interplanetary medium.

A major accomplishment of the ALAE experiment was the quantification (first ever) of the amount of deuterium in the thermosphere. It also saw auroras in the Northern and Southern hemispheres. Furthermore, ALAE found that by looking straight down at the nadir, it was possible to measure deuterium down to 85 km, below which the emission is significantly absorbed by O₂. Since the isotopic ratio is fairly well known at this altitude, the hydrogen density at 85 km can be inferred. This is a most important parameter, because the photochemistry of the mesosphere is dominated by reactions between oxygen and hydrogen species.

Selected References

Bertaux, J. L., F. Goutail and G. Kockarts (1984), Observations of Lyman-alpha Emissions of Hydrogen and Deuterium, Atmospheric Physics and Earth Observations, Science, 225(4658), 174-176, doi:10.1126/science.225.4658.174.

Bertaux, J. L., F. Goutail, E. Dimarellis, G. Kockarts and E. Van Ransbeeck (1984), First optical detection of atomic deuterium in the upper atmosphere from Spacelab I, Nature, 309, 771-773, doi:10.1038/309771a0.

Bertaux, J.-L., H. Le Texier, F. Goutail, R. and G. Kockarts, G. (1989), Lyman alpha observations of geocoronal and interplanetary hydrogen from Spacelab-1: Exospheric temperature and density and hot emission, Annales Geophysicae, 7, 549-563.

Bertaux, J. L., E. Quémerais, F. Goutail, G. Kockarts and B. Sandel (1993), Observations of atomic deuterium in the mesosphere from ATLAS I with ALAE instrument, Geophysical Research Letters, 20(6), 507-510, doi:10.1029/93GL00077.

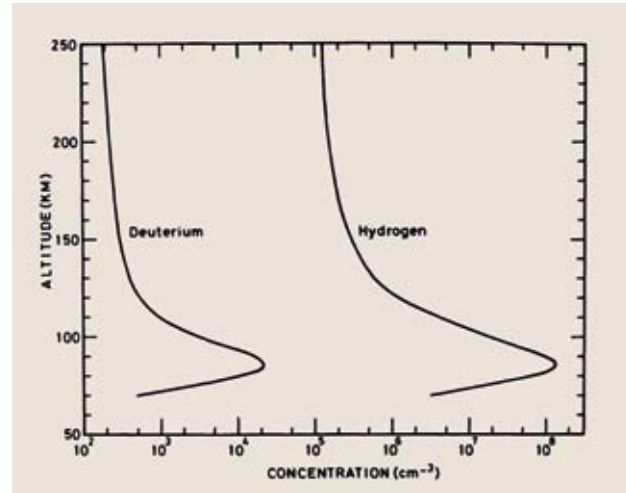

Typical vertical distribution of hydrogen and deuterium concentrations in the mesosphere and the thermosphere.

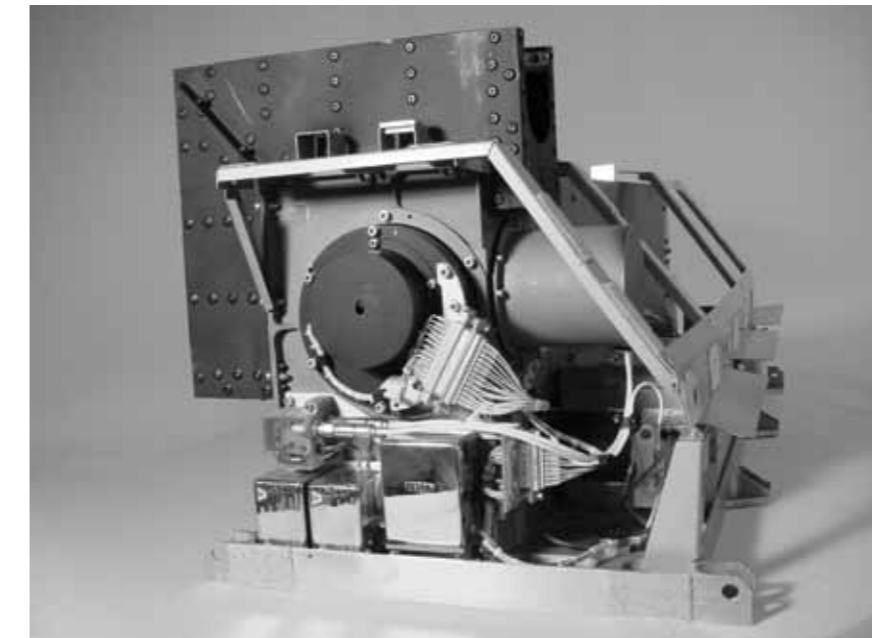

The ALAE experiment consisting of a spectrophotometer with an atomic hydrogen absorption cell and an atomic deuterium absorption cell, and a solar-blind photomultiplier for the detector.



The EURECA platform developed by ESA. The ORA instrument is located at the top-left of the module next to the SOSP experiment with the red cover. (credit: MBB/ERNO)

EURECA in orbit after release. (credit NASA)



THE EUROPEAN RETRIEVABLE CARRIER

Paul C. Simon

The **EUropean REtrievable CArrier (EURECA)** was launched on July 31, 1992 by the Space Shuttle Atlantis. The launch mass of EURECA was 4490 kg with a payload capacity of up to 1000 kg. At that time, EURECA was the largest spacecraft so far built and flown by ESA. The EURECA payload was deployed from the Shuttle on 2 August 1992 using the Remote Manipulator System. It was raised into a so-called circular Low Earth Orbit at an operational altitude of 508 km and an inclination of 28.45°, allowing to start its scientific mission on 7 August 1992. After a stay of 11 months in space, EURECA was retrieved on 1 July 1993 by the Space Shuttle Endeavor and returned to Earth.

The satellite carried a number of experiments for microgravity studies, atmospheric and solar observations, and material technology investigations, including a total of 16 active experiments and a number of entirely passive payloads. Among them, BIRA-IASB was involved in two experiments, namely the “Occultation Radiometer Instrument” (ORA) to measure aerosols and trace gases in the Earth’s mesosphere and stratosphere, and the “Solar Spectrum Instrument” (SOSP) to study solar physics and solar-terrestrial relationships in aeronomy and climatology.



Deployment of the EURECA satellite with the help of the Remote Manipulator System arm. (credit: NASA)



Photo of the EURECA Spacecraft release from the Space Shuttle on 2 August 1992. (credit: NASA, ESA)

REMOTE SENSING OF THE EARTH’S ATMOSPHERE BY THE SPACEBORNE OCCULTATION RADIOMETER

Didier Fussen and Filip Vanhellemont,
With contributions from Etienne Arijs† and Dennis Nevejans

The **Occultation RAdiometer ORA**, developed by the Belgian Institute for Space Aeronomy, is a simple UV–visible instrument that was launched in July 1992 on board the European Retrievable Carrier EURECA for a 11-month mission. The instrument consisted of eight broadband channels, ranging from 260 to 1013 nm, dedicated to the measurement of vertical profiles of O₃, NO₂, and H₂O number densities as well as of stratospheric aerosols.

Using the technique of solar occultation through the Earth’s atmosphere, ORA recorded 7000 sunsets and sunrises from a quasi-circular orbit at an altitude of 508 km. Although the low-orbit inclination of the satellite (28.45°) restricted the latitude coverage to 40°S and 40°N, the period of measurement was particularly interesting because it presented a unique opportunity for observing the relaxation of the huge stratospheric aerosol injection by the Mount Pinatubo eruption of June 1991. In particular, it was possible to infer the dynamical evolution of the particle size distribution by measuring the aerosol extinction profile at different wavelengths.

A major characteristic of ORA is its simple optics. The instrument has an optical field of view of 2° and its line of sight was aligned with the optical axis of the Sun-tracking system of the satellite. As a consequence, the apparent vertical resolution of the instrument appears to be poor (25 km), as it is defined by the size of the solar disk at the tangent point. However the signal-to-noise ratio was high for the same reason, suggesting that a large amount of information can be retrieved from the transmission and allowing the achievement of a 2-3 km vertical resolution.

ORA has been one of the first atmospheric sounders capable of producing a climatology of ozone profiles in the mesosphere (around the so-called second ozone maximum) thanks to its UV channel and the very high signal-to-noise ratio.



The ORA instrument.

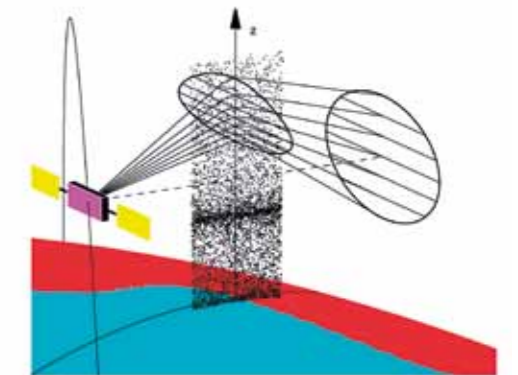

Simplified view of the solar occultation geometry as observed by ORA. Notice both refractive effects of the atmosphere: a change in the tangent altitude and an apparent flattening of the solar disc. Without atmosphere, a central ray (dashed line) would graze the Earth’s surface at a lower altitude than the true refracted ray. Note that rays emitted from the top of the Sun are less refracted than those emitted from the bottom, resulting in an inhomogeneous Sun flattening.

Selected References

Arijs, E., D. Nevejans, D. Fussen, P. Frederick, E. Van Ransbeeck, F.W. Taylor, S. B. Calcutt, S.T. Werrett, C. L. Heppelwhite, T.M. Pritchard, I. Burchell and C. D. Rodgers (1995), The ORA occultation radiometer on EURECA. Instrument description and preliminary results, *Advances in Space Research*, 16(8), 33-36, doi:10.1016/0273-1177(95)00264-F.

Fussen, D., F. Vanhellemont, C. Bingen and S. Chabrilat (2000), Ozone profiles from 30 to 110 km Measured by the Occultation Radiometer Instrument during the period Aug. 1992 - Apr. 1993, *Geophysical Research Letters*, 27(21), 3449-3452, doi:10.1029/2000GL011575.

Fussen, D., F. Vanhellemont and C. Bingen (2001), Remote sensing of the Earth's atmosphere by the spaceborne Occultation Radiometer; ORA: final inversion algorithm, *Applied Optics*, 40(6), 941-948, doi:10.1364/AO.40.000941.

Fussen, D., F. Vanhellemont and C. Bingen (2001), Evolution of stratospheric aerosols in the post-Pinatubo period measured by solar occultation, *Atmospheric Environment*, 35(30), 5067-5078, doi:10.1016/S1352-2310(01)00325-9.

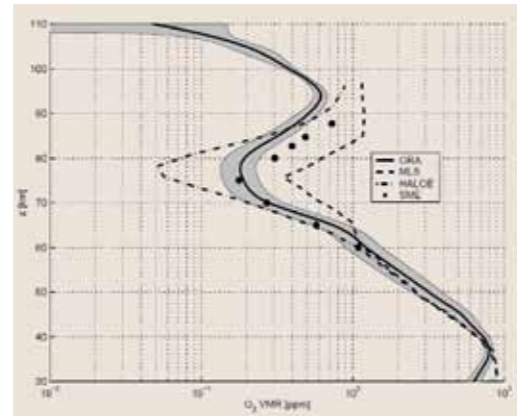

The ozone mesospheric layer as measured by ORA compared with other satellite instruments. The ozone volume mixing ratio profiles are averaged during the period Aug 1992-Apr 1993, between 40°S and 40°N.

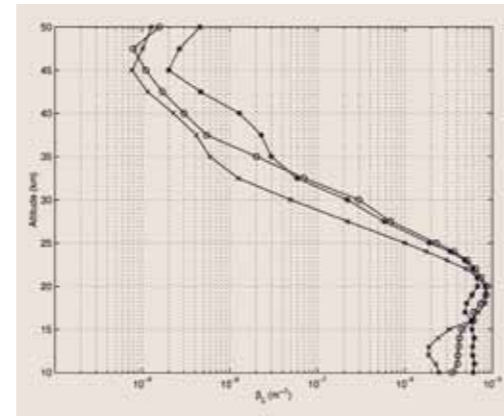

Aerosol extinction profiles measured by ORA in the post-Pinatubo period at different wavelengths: 0.34 (asterisks), 0.6 (circles) and 1.013 (crosses) micrometre.

THE SOLAR SPECTRUM INSTRUMENT ON BOARD EURECA

Paul C. Simon

The **SOLar SPectrum (SOSP)** is the spare unit of SOLSPEC. For this reason, both have identical design. Some of its components have been changed to meet the duration requirement of the six month mission in orbit for EURECA, instead of the 1 week mission on the Space Shuttle (SPACELAB 1 and the ATLAS series). The instrument combined three spectrometers, one for each spectral range, namely the UV, the visible and the IR domain. The optics of the three spectrometers is similar. The six gratings are mounted on a one-piece mechanical shaft and rotate by using a stepping motor. Only the IR detection system was improved. Internal calibration lamps are included in the instrument and consist of two deuterium lamps for the UV, and two tungsten ribbon lamps for the visible and IR spectrometers.

The scientific objectives of the EURECA/SOSP experiment concerned solar physics and solar-terrestrial relationships in aeronomy and climatology. Its purpose was to perform measurements of the absolute solar irradiance and its variations in the spectral range 170 - 3200 nm with an accuracy of 1% in the visible and the IR range, and 5% in UV, and, because of the duration of the mission, the short term variations related to the 27-day rotation of the Sun during solar cycle 23.

Selected Reference

Thuillier, G., M. DeLand, A. Shapiro, W. Schmutz, D. Bolsée and S. M. L. Melo (2003), The Solar Spectral Irradiance from 200 to 2400 nm as Measured by the SOLSPEC Spectrometer from the Atlas and Eureka Missions, *Solar Physics*, 214(1), 1-22, doi:10.1023/A:1024048429145.



BELEGCH INSTITUUT VOOR RUIMTE-AERONOMIE (BIRA) INSTITUUT D'AERONOMIE SPATIALE DE BELGIQUE (IASB) BELGIAN INSTITUTE FOR SPACE AERONOMY (BIRA-IASB) BELGIECH INSTITUUT VOOR RUIMTE-AERONOMIE (BIRA) INSTITUUT D'AERONOMIE SPATIALE DE BELGIQUE (IASB)

SATELLITE OBSERVATIONS

Paul C. Simon



Paul C. Simon

Artist View of ENVIRONMENTAL SATellite, ENVISAT.
(credit: ESA)

The Earth's atmosphere is changing due to the increasing anthropogenic release of chemically and radiatively active species. A better knowledge of the global composition of the atmosphere and of its long-term evolution is needed to assess current and future changes. Issues of primary concern since the discovery of the Antarctic ozone hole by scientists from the British Antarctic Survey in the mid-eighties are the evolution of the ozone layer in polar regions and at mid-latitudes and the understanding of the budgets of main stratospheric species controlling the chemical fate of stratospheric ozone. In more recent years, additional major concerns have emerged with the identification of the impact of human activities on the global Earth Climate, a problem intimately connected with changes affecting the quality of the air at the surface of the earth, the oxidative capacity (or self-cleansing capacity) of the atmosphere and the long-term evolution of the ozone layer.

Only remote sensing from satellite platforms can provide the required continuous measurements of relevant atmospheric trace species on the global scale that are needed to address these key environmental issues.

The satellite missions dedicated to atmospheric composition have been started in the 1970s mainly with instruments devoted to ozone monitoring (e.g. the Total Ozone Mapping Spectrometer (TOMS), the Stratospheric Aerosol and Gas Experiment I (SAGE I), the Solar Backscatter Ultraviolet radiometer (BUV/SBUV), ...). They were operated by either NASA or NOAA which insured the necessary continuity during the 1980s and the 1990s, with additional sounders on board a variety of satellites. A more complete study of the Earth's atmosphere was performed by the successful completion of the NASA Upper Atmospheric Research Satellite (UARS) mission, launched in 1991, on which some instruments kept working until 2005.

In the mid-1970s, ESA contributed to the geostationary meteorological satellites with the Meteosat series initiated by the World Meteorological Organisation (WMO). They are still in operation in this framework. On the other hand, some European scientists participated to NASA missions through their contribution to the definition of specific instruments and to the data analysis.

Thanks to the initiative of Christopher Readings, Head of the Earth Sciences Division officially founded in 1992, ESA became deeply involved in atmospheric missions, first with the Global Ozone Monitoring Experiment (GOME) instrument, lately added to the ERS-2 satellite platform, which was launched in April 1995 and which remained operational until 2011. The concept of this instrument was based upon the novel Differential Optical Absorption Spectroscopy (DOAS) method instead of the classical discrete multi-channel spectrometers used by the US agencies. BIRA-IASB was deeply involved in the preparatory phase, initiated by Christopher Readings, to convince both scientists and engineers from the ESA Earth Sciences Division of the advantages and the feasibility of this new measurement technique for space-based observations. The same instrument concept is still successfully used on the MetOp platforms with the Global Ozone Monitoring Experiment-2 (GOME-2). The scientific leadership of Europe for atmospheric chemistry missions was further strengthened with the ENVIRONMENTAL SATellite (ENVISAT) mission launched in 2002 and successfully operated until 2012, providing four years overlap with UARS.

The integration of GOME on the ERS-2 mission was also very important to demonstrate the new capabilities of the DOAS technique for the monitoring of the tropospheric composition, in particular of key anthropogenic pollutants such as nitrogen dioxide (NO_2), sulfur dioxide (SO_2) and formaldehyde (HCHO) as a proxy for non-methane volatile organic compounds. For the first time also a comprehensive validation programme was initiated for atmospheric composition products.

Since the early stage of its operation, scientists from BIRA-IASB, involved for many years in UV-visible remote sensing of atmospheric composition and global atmospheric modelling, have provided experimental, algorithmic and theoretical support to the GOME mission. Ground-based monitoring networks such as the international Network for the Detection of Stratospheric Change (NDSC, now renamed NDACC, see chapter 10) also played a central role in support of GOME and other satellite missions. This included the development of advanced correlative database facilities and validation methodologies, later also exploited in support of the ENVISAT mission.

DOAS

DOAS stands for Differential Optical Absorption Spectroscopy and is a method to quantify concentrations of trace gases by measuring their specific absorption structures in the ultraviolet and visible part of the light spectrum.

MetOp:

MetOp is a series of three polar orbiting meteorological satellites operated by the European Organisation for the Exploitation of Meteorological Satellites (EUMETSAT). MetOp has been developed as a joint undertaking between ESA and EUMETSAT.

Copernicus Programme
 Copernicus, previously known as GMES (Global Monitoring for Environment and Security), is the European Programme for the establishment of a European capacity for Earth Observation (from <http://www.copernicus.eu/>).

GOME was the successful example of a new generation of space-borne sensors deployed during the following decade and beyond: The SCanning Imaging Absorption SpectroMeter for Atmospheric CHartographY (SCIAMACHY) on board ENVISAT (2002-2012), the Ozone Monitoring Instrument (OMI) on board NASA's EOS Aura (2004-...), and the EUMETSAT MetOp GOME-2 series (2006-...). Owing to their early involvement in the GOME project, and shortly after in the ENVISAT mission (in particular within the Global Ozone Monitoring by Occultation of Stars, GOMOS, and SCIAMACHY teams), scientists of BIRA-IASB developed a strong and internationally recognised expertise allowing them to take important roles e.g. in EUMETSAT and in the various ENVISAT Quality Working Groups, but also in development teams working on the level-2 retrieval algorithms for the future Copernicus Atmospheric Sentinel missions of ESA.

Another essential evolution building on the ENVISAT expertise is the Atmospheric Limb Tracker for the Investigation of the Upcoming Stratosphere mission (ALTIUS) mission proposed by BIRA-IASB to fill the gap in atmospheric limb sensors. ALTIUS is an innovative spectro-imager capable of measuring atmospheric concentration profiles of trace gases in the upper atmosphere. Presently in development at the Institute, it will be embarked aboard a microsatellite of the PROject for On Board Autonomy (PROBA) class and will be operated in several observation modes: limb scattering, solar and stellar occultation.

BIRA-IASB is currently involved in the retrieval of vertical profiles of greenhouse gases and of aerosols from the Infrared Atmospheric Sounding Interferometer (IASI) developed by CNES, launched on board MetOp-A and MetOp-B in 2006 and 2012 respectively.

Remote sensing from an orbiting platform provides unique access to the global mapping of atmospheric constituents. Different observing modes are possible, using absorption or emission signatures of atmospheric constituents in the optical, thermal or millimeter-wave spectral ranges.

Occultation measurements observe light sources like the Sun or stars. Solar occultation occurs twice per orbit, every 100 min for a Sun-synchronous orbit at 800 km altitude, giving total content along the line of sight at different altitudes.

When scanning the limb, sensors observe only radiation scattered or emitted, providing altitude profile information, while looking at the nadir, sensors observe the radiation emitted, reflected or scattered by the atmosphere and the Earth's surface. The nadir-pointing geometry offers direct insight down into the troposphere. Therefore this is the preferred geometry to measure total column amounts. For some molecules, height-resolved information can also be retrieved from nadir measurements.

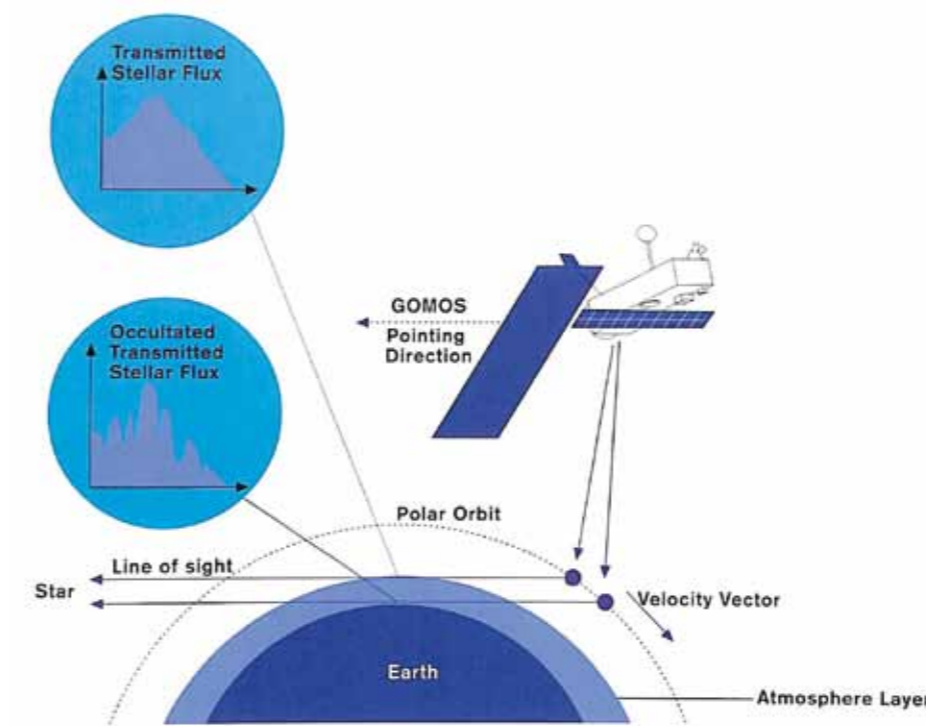

Figure 1: GOMOS star occultation viewing geometry, also valid for solar occultation measurements. (credit: ESA)

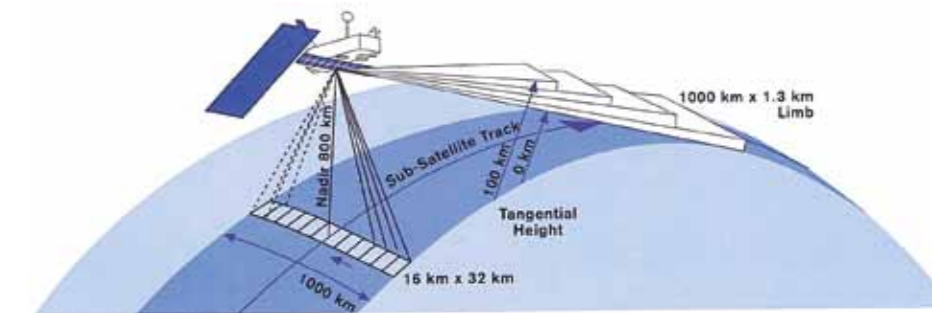

Figure 2: SCIAMACHY nadir and limb viewing geometry. (credit: ESA)

The solar spectral output monitoring is also continued on the International Space Station (ISS) with an improved Solar Spectrum (SOLSPEC) instrument, a heritage from the experiment already developed at the end of the seventies for the SPACELAB 1 mission.

In addition to these satellites dedicated to atmospheric studies, scientists at BIRA-IASB are also involved in different missions to detect the particles in space in the vicinity of Earth. It is mainly in the analysis of Van Allen radiation belts measurements that the space physics team of BIRA-IASB made many studies to determine the space weather variations of the fluxes during geomagnetic storms and develop empirical models of space radiations. Among the spacecraft used for these works, the proton fluxes measured by PET (Proton/Electron Telescope) on SAMPEX (Solar, Anomalous, and Magnetospheric Particle EXplorer) were analysed in detail, but Oersted, Equator-s, or Combined Release and CRRES (Radiation Effects Satellite) observations were also used, among others.

Due to this involvement in space radiation studies, BIRA-IASB participated with UCL, QinetiQ Space and with the support of ESA to the development of a new instrument to detect the fluxes of energetic particles in space with improved species discrimination: the Energetic Particle Telescope (EPT). BIRA-IASB was involved in all the different steps of the instrument development: the scientific requirements, the mechanical aspects for the building of the instrument (engineering team), the data transmission and satellite operations (B.USOC, see Chapter 16) after the launch on the PROBA-V satellite on 7 May 2013, and presently the scientific analysis of the data (space physics team).

Also other regions of the magnetosphere are studied at BIRA-IASB. This started with detailed studies of Active Magnetospheric Particle Tracer Explorers (AMPTE-IRM) and WIND data, but culminated in a strong involvement in the observations of the Cluster satellites launched in 2000 and flying in formation on a polar elliptical orbit. Cluster, an ESA cornerstone mission, is composed of four identical spacecraft that are determining the physical processes involved in the interaction between the solar wind and the magnetosphere in key plasma regions. Such a multi-spacecraft mission required the development of new data interpretation techniques. BIRA-IASB is Co-Investigator of the instrument WHISPER (Waves of High frequency and Sounder for Probing of Electron density by Relaxation experiment) to determine the density of electrons. These data have been used to study the plasmasphere and the position of the plasmapause. Comparisons were made with the observations of the NASA satellite IMAGE. In addition, observations of the instruments CIS and RAPID on Cluster were analysed to study the interactions between the low energy particles of the plasmasphere with the energetic particles of the radiation belts. Empirical reconstruction techniques were developed at BIRA-IASB to advance our understanding of the Earth's magnetopause and boundary layer. Cluster measurements of the auroral regions have been coordinated with observations on the ground (e.g. the EISCAT radar) and with low-altitude satellite data (e.g. from the NASA Defense Meteorological Satellite Program; DMSP). High resolution plasma and magnetic field data are used to study turbulence. The ESA Cluster mission is still active and continues to produce interesting data. Such long term datasets are very important for space weather prediction.

In the future, BIRA-IASB heads the development of a pico-satellite called PICO-satellite for Atmospheric and Space Science Observations (PICASSO) in the framework of the international network of 50 CubeSats (QB50 project) development in Europe. Its VISION payload will perform remote sensing observations of the upper atmosphere, mainly during solar occultations. There will also be Langmuir probes on board to study ionospheric density and temperature.

The CubeSat Satellite
A CubeSat is a miniaturised satellite consisting of units with a volume of one liter (10cm x 10 cm x 10cm), weighing about 1 kg, and offering the reduced functionality of a normal satellite. The historical objective of developing, launching and operating a CubeSat was educational but very small satellites may become soon a standard solution for atmospheric remote sounding.

BIRA-IASB satellite contributions have not been limited to the immediate vicinity of Earth. The Institute was an Interdisciplinary Investigator in the ULYSSES mission launched in 1990 to explore for the first time the solar wind outside the ecliptic plane. Since then, there have been involvements in instrument hardware and in the scientific return of planetary missions (see chapter 13).

THE GLOBAL OZONE MONITORING EXPERIMENT

Jean-Christopher Lambert and Paul C. Simon
With contributions from Isabelle De Smedt and Nicolas Theys

The **Global Ozone Monitoring Experiment (GOME)** is an instrument on board the ERS-2 (European Remote Sensing) satellite, the first satellite ever, entirely built and operated by Europe, to monitor ozone and atmospheric composition. Launched by the European Space Agency (ESA) on 21 April 1995, it was in operation for 16 years, although with limited data downlink since the failure of the satellite tape recorder in June 2003. ERS-2 flies in a Sun-synchronous polar orbit with an inclination of 98°, at an altitude of 780 km. This results in an orbital period of about 100 minutes and 14 orbits per day. The satellite crosses the equator at a local time of 10h30 at the day side of the Earth, flying from North to South. The objectives of this nadir-looking UV-visible spectrometer cover a wide range of scientific fields, going from stratospheric ozone to atmospheric pollution monitoring.

The purpose of GOME is to observe the upwelling solar radiation reflected or scattered by the Earth's atmosphere and from its surface. The measured spectrum contains absorption features which can be used to derive quantitative information on the presence of ozone and of a number of other atmospheric species. The GOME measurement concept is based on "Differential Optical Absorption Spectroscopy" (DOAS), a technique proven in ground-based and stratospheric balloon observations.

The full width of a normal GOME scanning swath is 960 km, which is divided in three ground pixels (named east, centre or nadir, and west, relative to viewing straight down). The scan measures 40 km in the direction of flight. Its nadir-looking geometry makes it particularly suited for vertical column and tropospheric observations. Its polar orbit yields global coverage in less than three days at the equator and daily in polar areas.

The instrument also measures the solar spectrum directly. The ratio between the Earthshine and solar signal is a measure of the reflectivity of the Earth's atmosphere and surface.

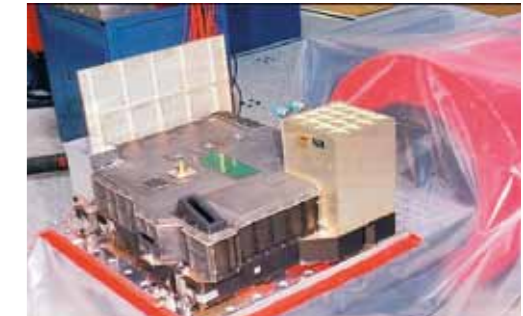

The GOME instrument during vibration tests. (credit: ESA)

Sun-synchronous or Heliosynchronous Polar Orbit: In a Sun-synchronous polar orbit, the satellite is moving around Earth from pole to pole, crossing the equator at approximately the same local time each day (and night). This orbit allows consistent scientific observations with the angle between the Sun and the Earth's surface remaining relatively constant.

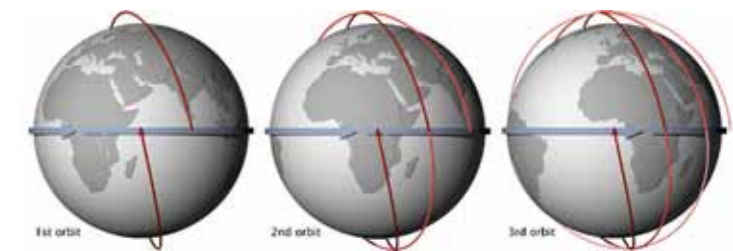

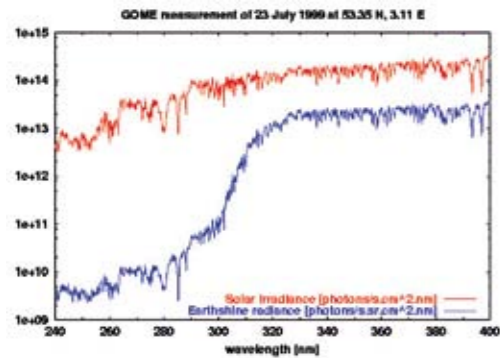

Solar irradiance and terrestrial radiance measured by GOME on 23 July 1999 (courtesy of TEMIS project).

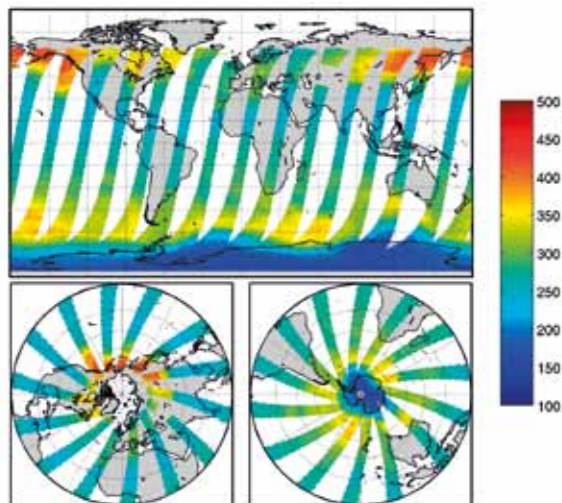

Worldwide map (on the top) and Arctic and Antarctic maps of total ozone content on 26 November 1998 derived from GOME observations. The Antarctic ozone hole is clearly visible. (credits: ESA, EUMETSAT, CCI)

The GOME instrument consists of a UV-visible grating double spectrometer observing the solar irradiance and the solar radiation backscattered from both the atmosphere and the Earth's surface, between 240 and 790 nm with a medium spectral resolution of 0.2 nm in the UV and 0.4 nm in the visible and near IR. Its scientific objectives are the measurement of the total ozone column and stratospheric and tropospheric profiles of ozone on a daily basis.

GOME demonstrated the feasibility of tropospheric trace species observations from space. It is also the first satellite providing global, continuous measurement of nitrogen dioxide (NO_2), bromine oxide (BrO), formaldehyde (HCHO) and sulphur dioxide (SO_2) and the measurement of total columns of water vapour (H_2O). GOME can also be used to investigate the distribution of atmospheric aerosols, clouds and surface spectral reflectance.

GOME is the successful predecessor of a series of new generation sensors like SCIAMACHY on board ESA's ENVISAT (operating from 2002 to 2012), OMI on board NASA's EOS Aura, launched in July 2004 and operating for 8 years, and GOME-2 on board the EUMETSAT/MetOp series of meteorological satellites launched in October 2006.

Among major achievements, GOME, followed by SCIAMACHY, have started a unique long-term ozone data record extending those initiated in the late 1970s by TOMS and SBUV missions.

A wide range of important issues is studied based on the datasets provided by GOME: the trend in the ozone hole and a possible recovery of the ozone layer in the future, the amount and global distribution of air pollution, changes in the amount of human-related emissions (such as fossil fuel and biomass burning) and

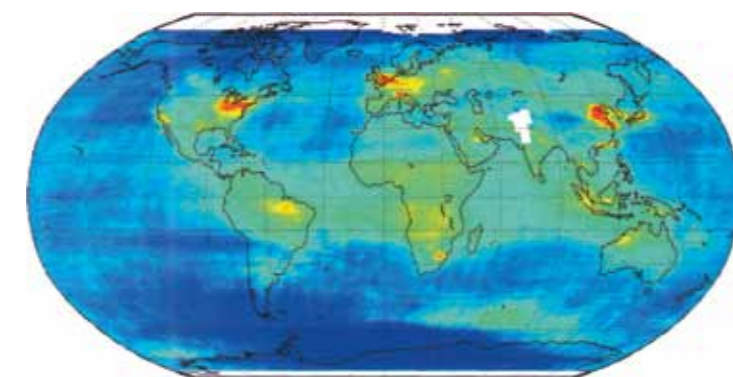

Global picture of the tropospheric NO_2 column (in 10^{15} molecules/ cm^2) for October 1997 derived from GOME measurements. Emission sources are clearly discernible, such as major cities, large industrial regions, and tropical biomass burning. Long-range transport across the oceans is also visible. Enhanced NO_2 in the Southern Indian Ocean arises from an algorithm artefact that will be fixed in a future version.

natural emissions (e.g. emissions from soils and vegetation, lightning), trends in ozone in the lower atmosphere related to these changes in the atmospheric composition, the relation between changes in ozone and the greenhouse effect, etc.

Since the early stage of GOME operation, scientists from BIRA-IASB, involved for many years in the UV-visible remote sensing of atmospheric composition, have provided experimental and theoretical support to the GOME mission. The central role played by ground-based monitoring networks such as the international Network for the Detection of Stratospheric Change (NDSC, now NDACC) in support of GOME and other satellite systems has to be highlighted (see chapter 10).

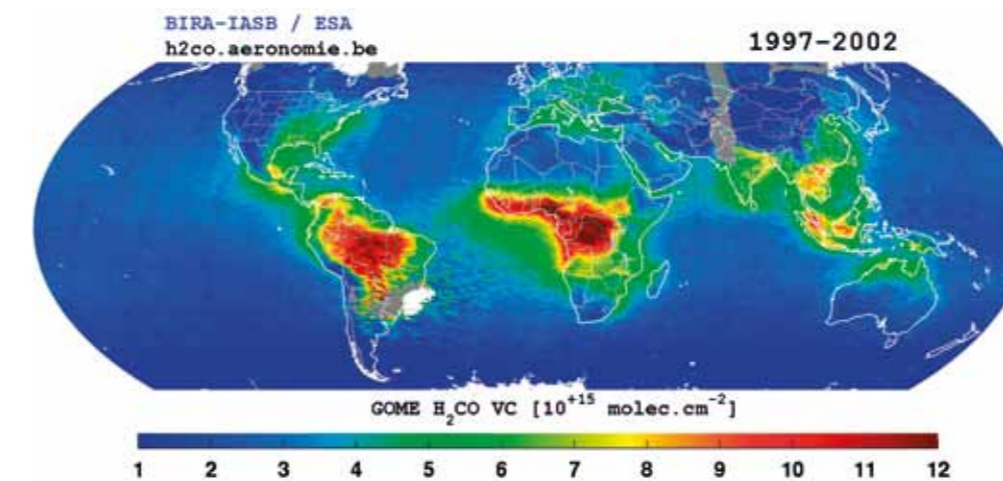

Formaldehyde vertical column concentration averaged over 5 years of GOME observations. The biomass burning zones where the production of formaldehyde is very high are clearly identified.

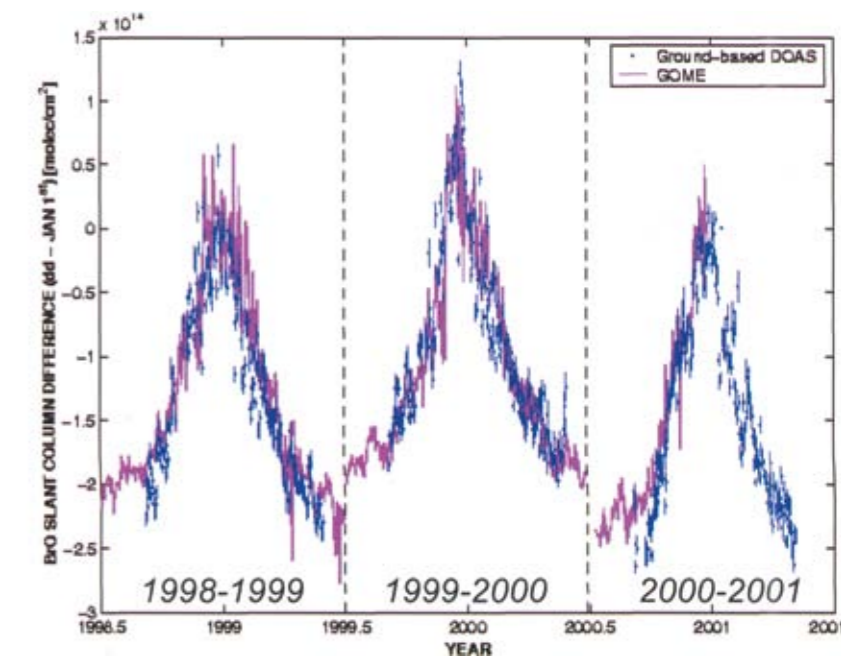

Comparison between BrO differential slant columns amounts (taken relative to the 1st of January each year) simultaneously measured by GOME and by the DOAS spectrometer operated by BIRA-IASB at the Harestua station (Norway, 60°N). The large seasonal variation of the measured BrO differential slant columns is mainly due to the seasonal variation of the local solar zenith angle.

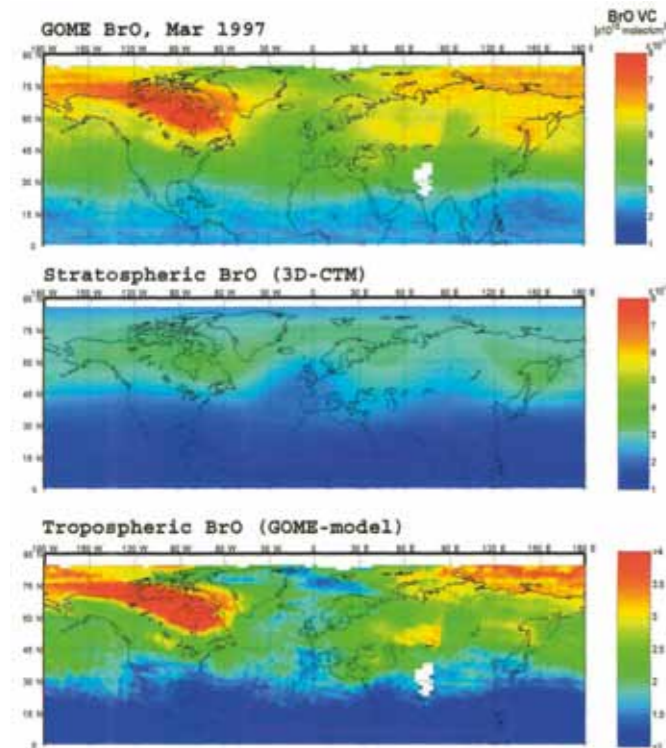

Total vertical column of BrO over the Northern Hemisphere for March 1997 as derived from GOME measurements (upper map), stratospheric BrO column from the 3-dimensional Chemical Transport Model SLIMCAT (middle map), and estimated residual tropospheric BrO column (lower map).

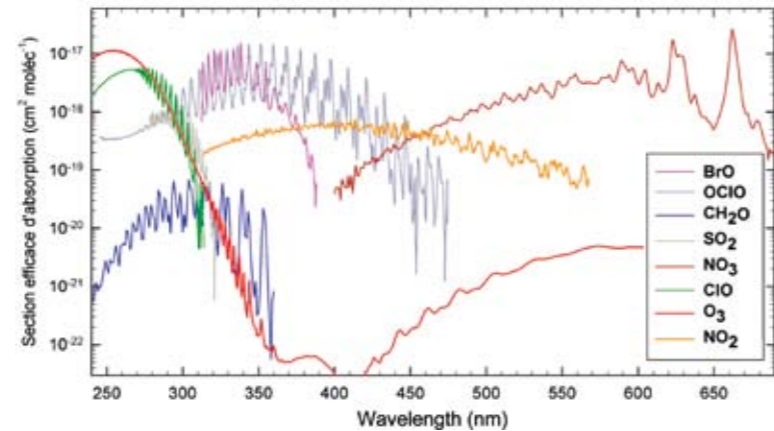

Absorption cross sections of trace gases retrieved with the Differential Optical Absorption Spectroscopy (DOAS) technique used by the GOME observations.

Selected References

Meijer, Y. J., D. P. J. Swart, F. Baier, P. K. Bhartia, G. E. Bodeker, S. Casadio, K. Chance, F. Del Frate, T. Erbertseder, M. D. Felder, L. E. Flynn, S. Godin-Beekmann, G. Hansen, O. P. Hasekamp, A. Kaife, H. M. Kelder, B. J. Kerridge, J. C. Lambert, J. Landgraf, B. Latter, X. Liu, I. S. McDermid, Y. Pachepsky, V. Rozanov, R. Siddans, S. Tellmann, R. J. van der A, R. F. van Oss, M. Weber and C. Zehner (2006), Evaluation of Global Ozone Monitoring Experiment (GOME) ozone profiles from nine different algorithms, *Journal of Geophysical Research: Atmospheres*, 111(D21), doi:10.1029/2005JD006778.

Thomas, W., T. Erbertseder, T. Ruppert, M. Van Roozendael, J. Verdebout, D. Balis, C. Meleti and C. Zerefos (2005), On the retrieval of volcanic sulfur dioxide emissions from GOME backscatter measurements, *Journal of Atmospheric Chemistry* 50(3), 295-320, doi:10.1007/s10874-005-5544-1.

Van der A, R. J., H. J. Eskes, K. F. Boersma, T. P. C. van Noije, M. Van Roozendael, I. De Smedt, D. H. M. U. Peters and E. W. Meijer (2008), Trends, seasonal variability and dominant NO_x source derived from a ten year record of NO₂ measured from space, *Journal of Geophysical Research: Atmospheres*, 113(D4), doi:10.1029/2007JD009021.

Van Roozendael, M., T. Wagner, A. Richter, I. Pundt, D. W. Arlander, J. P. Burrows, M. Chipperfield, C. Fayt, P. V. Johnston, J. C. Lambert, K. Kreher, K. Pfeilsticker, U. Platt, J. P. Pommereau, B. M. Sinnhuber, K. K. Tørnkvist and F. Wittrock (2002), Intercomparison of BrO Measurements from ERS-2 GOME, Ground-based and Balloon Platforms, *Advances in Space Research*, 29(11), 1661-1666, doi:10.1016/S0273-1177(02)00098-4.

Van Roozendael, M., R. Spurr, D. Loyola, C. Lerot, D. Balis, J. C. Lambert, W. Zimmer, J. van Gent, J. van Geffen, M. Koukoulis, J. Granville, A. Doicu, C. Fayt and C. Zehner (2012), Sixteen years of GOME/ERS-2 total ozone data: The new direct-fitting GOME Data Processor (GDP) Version 5: 1. Algorithm Description, *Journal of Geophysical Research: Atmospheres*, 117(D3), doi:10.1029/2011JD016471, 2012.

THE ENVIRONMENTAL SATELLITE

Paul C. Simon

The ENVIRONMENTAL SATELLITE (ENVISAT) is an advanced Polar-Orbiting Earth-Observation Mission (POEM) of ESA, providing measurements of the atmosphere, ocean, land, and ice. POEM-I, initially conceived as a combined mission with instruments for scientific application, research, and operational meteorology, was to be mounted onto the Polar Platform (PPF), which initially started as an element of the Columbus Space Station Programme.

After the selection of the Polar Platform as a derivative of SPOT-4, the ESA council started the PPF development activities in 1990. In December 1993, it was decided at the Ministerial ESA council meeting that, for cost saving reasons, the POEM-I mission was to be split into an environmental mission (ENVISAT) and a meteorological mission (MetOp). Soon after, the development of the payload instruments for ENVISAT could start. ENVISAT was finally launched on the 1st of March 2002, into a Sun-synchronous polar orbit at an altitude of about 800 km. Contact was lost in April 2012, and the mission officially ended on the 9th of May 2012, after 10 years of operation.

With an in-orbit configuration of 26m x 10m x 5m and a total mass of 8211 kg, ENVISAT was the largest and most advanced Earth observation satellite ever built in Europe. It had an ambitious and innovative payload on board (occupying 2118 kg of the total mass) that would ensure the continuity of the (radar) data measurements of the two Earth Remote Sensing (ERS) satellites, which were launched in respectively 1991 and 1995. The goal of this mission was to support earth science research and to provide validated data for the long-term monitoring of environmental and climatic changes, on various scales, from local through regional to global. The major disciplines covered meteorology, climatology, environment, atmospheric chemistry, vegetation, hydrology, land use, ocean and ice processes.

Two proposals related to atmospheric chemistry and involving the participation of BIRA-IASB scientists were introduced to ESA in 1988: SCIAMACHY and GOMOS.

SCIAMACHY (SCanning Imaging Absorption spectroMeter for Atmospheric CHartography) was proposed by four institutes, namely the "Institute of Environmental Physics, University of Bremen" (IUP, Germany), the Harvard-Smithsonian Center for Astrophysics, Cambridge (USA), the "Netherlands Institute for Space Research" (SRON, The Netherlands) and BIRA-IASB (Belgium) and was funded jointly by Germany, The Netherlands and Belgium.



Artist's rendition of the deployed ENVISAT spacecraft.



ENVISAT during vibration testing at ESTEC.



Continuity of ERS and ENVISAT missions for earth sciences and environmental monitoring.

SCIAMACHY is an imaging spectrometer whose objectives were to perform global measurements of trace gases in the troposphere and in the stratosphere. The solar radiation transmitted, backscattered and reflected by the atmosphere is recorded at relatively high resolution over the range 240 nm to 1700 nm, and in selected regions between 2000 nm and 2380 nm. SCIAMACHY has three different viewing geometries: nadir, limb, and solar/lunar occultation which yield total column values as well as distribution profiles in the stratosphere and (in some cases) the troposphere for trace gases, clouds and aerosols.

Belgium (and in particular BIRA-IASB) contributed to different phases of SCIAMACHY, going from the development, validation and exploitation of scientific data products to industrial knowledge of the instrument itself and with respect to certain data products.

The experience gained in GOME and in the scientific preparation for SCIAMACHY provided the basis of the contribution of BIRA-IASB to the international effort to produce SCIAMACHY data products.

GOMOS (Global Ozone Monitoring by Occultation of Stars) was proposed by three institutes, namely the Service d'Aéronomie (now LATMOS, "Laboratoire Atmosphères, Milieux, Observations Spatiales") of the CNRS (Centre National de la Recherche Scientifique) in France, the Finnish Meteorological Institute (FMI) in Finland and BIRA-IASB. Scientists from BIRA-IASB were selected as members of the GOMOS Science Advisory Group and were deeply involved in the instrument definition. GOMOS is a medium-resolution spectrometer, measuring the atmospheric composition by detecting absorption of starlight in ultraviolet, visible and near-infrared wavelengths.

Selected References

Bertaux, J. L., R. Pellinen, P. C. Simon, E. Chassefière, F. Dalaudier, S. Godin, F. Goutail, A. Hauchecorne, H. Le Texier, G. Mégie, J. P. Pommereau, G. Brasseur, E. Kyrölä, T. Tuomi, S. Korpela, G. Leppelmeier, G. Visconti, P. Fabian, S. A. Isaksen, S. H. Larsen, F. Stordahl, D. Cariolle, J. Lenoble, J. P. Naudet and N. Scott (1988), GOMOS, proposal in response to ESA EPOP-I, A.O.I.

Bertaux, J. L., G. Mégie, T. Widemann, E. Chassefière, R. Pellinen, E. Kyrölä, E. Korpela and P. Simon (1991), Monitoring of ozone trend by stellar occultations: the Gomos instrument, *Advances in Space Research*, 11 (3), 237-242, doi:10.1016/0273-1177(91)90426-K.

Burrows J. P., K. V. Chance, P. J. Crutzen, H. van Dop, J. C. Geary, T. J. Johnson, G. W. Harris, I. S. A. Isaksen, G. K. Moortgat, C. Müller, D. Perner, U. Platt, J.-P. Pommereau, H. Rodhe, E. Roedner, W. Schneider, P. C. Simon, H. Sundqvist and J. Vercheval (1988), SCIAMACHY – A European proposal for atmospheric remote sensing from the ESA Polar Platform, Max-Planck-Institut für Chemie, Mainz, Germany.

THE SCANNING IMAGING ABSORPTION SPECTROMETER FOR ATMOSPHERIC CHARTOGRAPHY: 10 YEAR MEASUREMENTS OF OUR CHANGING ATMOSPHERE

Jean-Christopher Lambert

The SCIAMACHY Instrument

The SCanning Imaging Absorption spectroMeter for Atmospheric CHartographY (SCIAMACHY) is a joint project of Germany, the Netherlands and Belgium, with BIRA-IASB as co-Principal Investigator. The instrument is a passive remote sensing spectrometer measuring sunlight backscattered, transmitted and reflected by the Earth's atmosphere and surface in the ultraviolet, visible and near infrared spectral range (240 nm - 2380 nm) at moderate spectral resolution (0.2 nm - 1.5 nm). Two key innovations make of SCIAMACHY a unique instrument: its three observation modes (nadir, limb, and solar/lunar occultation), offering sensitivity to many more atmospheric layers than any other instrument (from the lower troposphere through the stratosphere up to the mesosphere), while its extended spectral range offers access to the measurement of a wide variety of trace gases absorbing or scattering light.

The Scientific Targets

SCIAMACHY was designed to measure incoming solar radiation and atmospheric radiation, the latter carrying absorption and scattering signatures of various trace gases. These radiation measurements can be inverted to derive the total column and vertical distribution of key atmospheric constituents in numerous thematic domains such as: stratospheric ozone and UV radiation, greenhouse gases and climate change, reactive gases and air quality, solar activity and upper atmosphere impacts, volcanic eruptions and hazards to aviation, and chemistry and dynamics of the troposphere, stratosphere and mesosphere. Among the targeted atmospheric gases and parameters, BIRA-IASB has contributed to the development, validation and exploitation of ozone (O₃), nitrogen dioxide (NO₂), bromine oxide (BrO), chlorine dioxide (ClO), formaldehyde (HCHO), glyoxal (CHOCHO), methane (CH₄), carbon monoxide (CO), carbon dioxide (CO₂), water vapour (H₂O), sulfur dioxide (SO₂), and volcanic ashes.

SCIAMACHY Ozone and Climate Data Records

From the 1970s until the late 1990s, due to enhanced stratospheric concentrations of manmade halogens, a continuous decrease of up to 3-6% per decade in the total ozone abundance had been observed over the middle and polar latitudes. The discovery in the mid 1980s of a massive loss of stratospheric ozone over Antarctica every springtime, known as the ozone "hole", led to the Montreal Protocol, agreed on 16 September 1987 and entered into force on 1 January 1989 to reduce the production and consumption

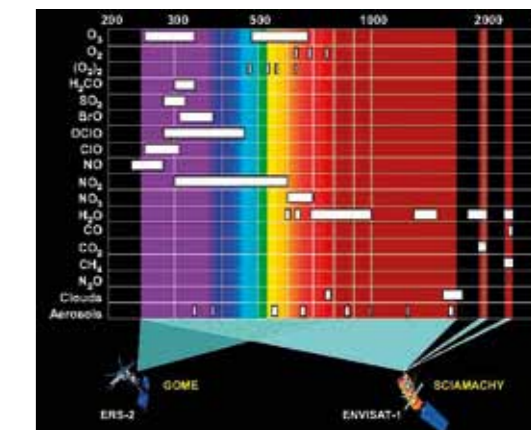

The high resolution and the wide wavelength range of SCIAMACHY make it possible to detect many different trace gases.

SCIAMACHY

The name SCIAMACHY has been chosen as a reference to the Greek name "skiamakhia" (skia - "shade, shadow", makhe - "battle") which means "fighting with shadows, shadow-boxing", dating back to 1623. Literally, it would rather be translated as "fighting in the shade" (i.e., in school; ancient teachers taught in shaded public places such as porches and groves)". From the Online Etymology Dictionary. Copyright: Douglas Harper, Historian, 21 June 2014.

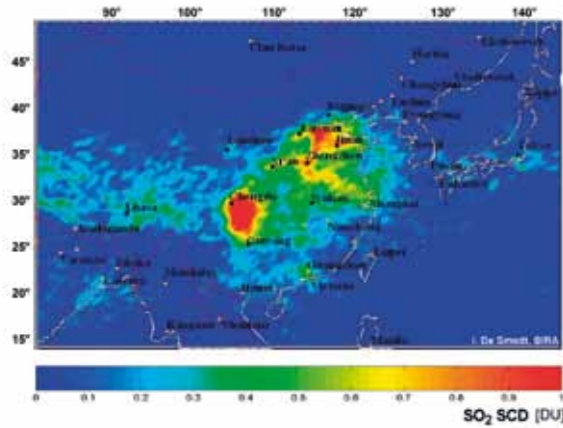

SCIAMACHY measurements of sulfur dioxide above China, averaged over the period August 2002 - February 2004 (slant column densities in Dobson Unit). The high resolution of SCIAMACHY enables identification of pollution sources at unprecedented detail. (credit: TEMIS)

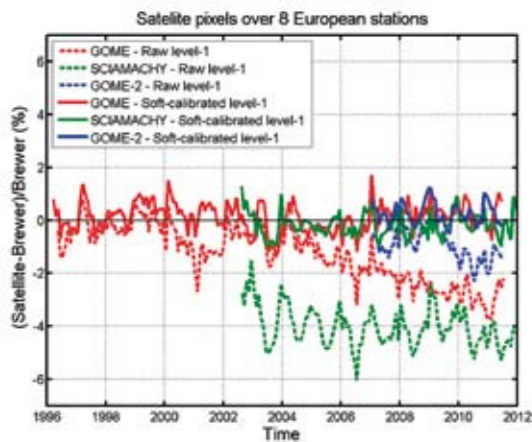

The 1% agreement of ozone column data measured over 1996-2012 by 3 consecutive European satellites (GOME, SCIAMACHY, and GOME-2) and 8 stations of the Brewer reference network. Dashed lines: initial data processing; solid lines: climatic ozone data records recalibrated and reprocessed at BIRA-IASB. (credit: AGU 2013)

of ozone-depleting substances, and thereby protect the Earth's fragile ozone layer. During its ten years of operation, SCIAMACHY has monitored the life cycle of every springtime polar ozone hole, including the controlling role of NO_2 and the wintertime conversion of inert halogen reservoirs into ozone depleting forms of chlorine and bromine and their products (BrO, ClO, OClO). SCIAMACHY has also measured the stabilization of stratospheric ozone at polar and middle latitudes as a result of the Montreal Protocol. Now that the SCIAMACHY mission has been terminated, BIRA-IASB continues the monitoring of stratospheric ozone, springtime polar ozone depletion and the evolution of species impacting stratospheric chemistry, in order to detect possible signs of recovery, and to better identify and understand interactions between climate change (e.g., cooling of the stratosphere and strengthening of the Brewer-Dobson circulation) and the expected recovery of the ozone layer.

Monitoring Air Quality and Natural Hazards with SCIAMACHY

With the steady increase of anthropogenic emissions over the last decades, air quality and atmospheric pollution have become a major concern. SCIAMACHY has measured at unprecedented resolution, and often for the first time from space, several gases emitted by power plants, traffic, agriculture, forced biomass burning, ... but also by natural sources like lightning, natural biomass burning, microbiological activity and volcanic eruptions. From SCIAMACHY spectra, BIRA-IASB has generated global data sets to study emissions and transport of NO_2 , SO_2 , BrO, OClO, CHOCHO, and HCHO. Figure on the top shows the mean distribution of sulfur dioxide over China, produced by combustion of coal and fossil fuels. The combination of SCIAMACHY data with those from GOME (1995-2003) and GOME-2 (from 2006 onwards) enables the assessment of sources, transport, sinks and trends of manmade pollutants, and of the impact of environmental regulations over the past 20 years. Besides anthropogenic sources of pollution, natural sources exist, such as volcanic eruptions. In addition to SO_2 and ashes, volcanoes release large amounts of halogen species such as HCl and HBr, which can be converted into reactive halogens by heterogeneous photochemical reactions that are currently not fully characterized. Satellite measurements by SCIAMACHY were the first to detect volcanic OClO in addition to BrO, suggesting that OClO is formed in the plume by the ClO + BrO reaction in presence of a large excess of ClO (see also chapter 14).

Selected References

De Smedt, I., J. F. Müller, T. Stavrou, R. van der A, H. Eskes and M. Van Roozendael (2008), Twelve years of global observations of formaldehyde in the troposphere using GOME and SCIAMACHY sensors, *Atmospheric Chemistry and Physics*, 8(16), 4947-4963, doi:10.5194/acp-8-4947-2008.

Dils, B., M. De Mazière, J. F. Müller, T. Blumenstock, M. Buchwitz, R. de Beek, P. Demoulin, P. Duchatelet, H. Fast, C. Frankenberg, A. Gloudemans, D. Griffith, N. Jones, T. Kerzenmacher, I. Kramer, E. Mahieu, J. Mellqvist, R. L. Mittermeier, J. Notholt, C. P. Rinsland, H. Schrijver, D. Smale, A. Strandberg, A. G. Straume, W. Stremme, K. Strong, R. Sussmann, J. Taylor, M. van den Broek, V. Velasco, T. Wagner, T. Warneke, A. Wiaček and S. Wood (2006), Comparisons between SCIAMACHY and ground-based FTIR data for total columns of CO , CH_4 , CO_2 and N_2O , *Atmospheric Chemistry and Physics*, 6(7), 1953-1976, doi:10.5194/acp-6-1953-2006.

Gottwald, M. and H. Bovensmann (Eds.) (2011), *SCIAMACHY: exploring the changing Earth's atmosphere*, Springer, Dordrecht.

Lerot, C., M. Van Roozendael, R. Spurr, D. Loyola, M. Coldewey-Egbers, S. Kochenova, J. van Gent, M. Koukouli, D. Balis, J. C. Lambert, J. Granville and C. Zehner (2014), Homogenized total ozone data records from the European sensors GOME/ERS-2, SCIAMACHY/Envisat, and GOME-2/MetOp-A, *Journal of Geophysical Research: Atmospheres*, 119(3), 1639-1662, doi:10.1002/2013JD020831.

GLOBAL OZONE MONITORING BY OCCULTATION OF STARS ON BOARD ENVISAT: 10 YEARS OF STELLAR OCCULTATIONS.

Didier Fussen, Filip Vanhellemont and Cédric Tétard

Global Ozone Monitoring by Occultation of Stars (GOMOS) is a spectrometer on board the ESA's ENVISAT satellite. It is the first space instrument that uses the stellar occultation measurement principle for monitoring ozone and other trace gases in the Earth's stratosphere. The part of the electromagnetic spectrum covered by the instrument is the ultraviolet and visible (250-675 nm) and the near infrared (two channels at 756-773 nm and at 926-952 nm). The UV-visible spectral range is used for the determination of O_3 , NO_2 , NO_3 , aerosols and temperature. The two IR channels, on the other hand, allow measurements of O_2 and H_2O . Two fast photometers (frequency of 1 kHz), working in the blue (473-527 nm) and red (646-698 nm) spectral domain, are used to demodulate the star scintillation and to determine high vertical resolution temperature profiles.

Measurements cover the entire vertical range between 5 and 150 km. Atmospheric data are obtained in the range 15-100 km for ozone, while other constituents have more restricted vertical coverage.

Depending on the time of year, there are 150 to 300 stars that are bright enough for GOMOS to track and that are in the field of view of the instrument at specific times during an orbit. Since the actual occultation time windows often overlap each other, they cannot all be observed. Therefore, a number of alternative



Cutaway view of the GOMOS instrument on ENVISAT (credit: ESA).

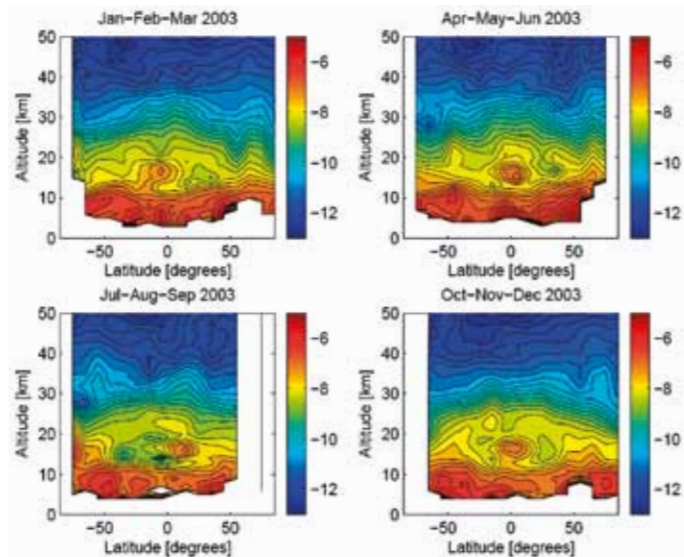

Isolines of the natural logarithm of the optical extinction profiles (in km^{-1} units) at 500 nm.

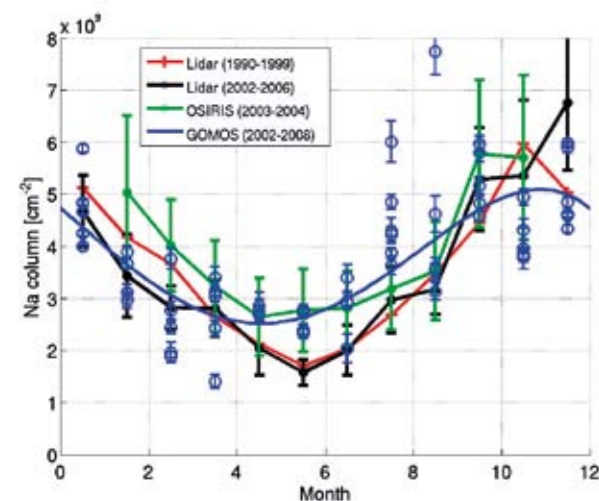

Intercomparison of mesospheric sodium column measurements, measured in the 30°–50° latitude band. GOMOS data (blue) are compared with two lidar climatologies at Fort Collins (41°N) for a different period (red and black) and with remote sensing results by the OSIRIS instrument on board the ODIN satellite

occultation sequences can be planned. Each sequence has different characteristics, for example, with respect to the ozone retrieval.

BIRA-IASB was selected by ESA as one of the three Expert Support Laboratories for the GOMOS mission in collaboration with LATMOS (France) and FMI (Finland). This implies an extended knowledge of the instrument, of the observation method and of the complicated inversion algorithm. The GOMOS proposal was initiated in 1988 and ENVISAT was launched in 2002. Although the satellite stopped working in Spring 2012, the data processing is still improving and will take several years for a complete analysis.

In particular, BIRA-IASB has obtained spectacular results with the measurements of stratospheric aerosols, of the mesospheric sodium layer and the climatology of OCIO in the upper stratosphere.

The current GOMOS operational aerosol/cloud product consists of optical extinction profiles at 500 nm and additional spectral coefficients to evaluate the extinction at other wavelengths as well. The quality of the product is not optimal yet, due to an unfortunate spectral law implementation, combined with an altitude smoothing that is too strong. Furthermore, profiles derived from bright limb measurements are currently not usable. Nevertheless, if we restrict ourselves to the use of 500 nm extinction profiles retrieved from dark limb measurements, then the quality can be considered as good, although fine structure has been smoothed. A comparison with SAGE II, SAGE III and POAM III showed a good agreement within 20 % in the upper troposphere/lower stratosphere, from 10 km to about 25 km.

Thanks to special statistical techniques, our team was able to detect and measure the concentration profiles of the mesospheric sodium layer, of which the first global climatology has been published in 2012. The principal result of this climatology is the discovery of a double pattern for the mesospheric sodium latitudinal and temporal distribution, i.e. a semi-annual equatorial oscillation that merges into an annual polar oscillation. This was unreported so far in the literature and this pattern turns out to be quite similar to the ozone distribution measured by GOMOS. The important subsidence observed during polar winter, was also shown demonstrating the accepted view of the general mesospheric circulation driven by the seasonal gravity wave break-up.

Thanks to the use of the same signal virtualization technique, we have also been able to discover the presence of an equatorial OCIO layer that was unreported. A validated climatology of this important chemical constituent has been published in 2013.

So far, BIRA-IASB has been involved in 31 publications about GOMOS in peer-reviewed international journals, awarding more than 15 years of efforts.

Unfortunately the end of ENVISAT mission induced a break in the continuity of the measurement of atmospheric profiles with a high vertical resolution.

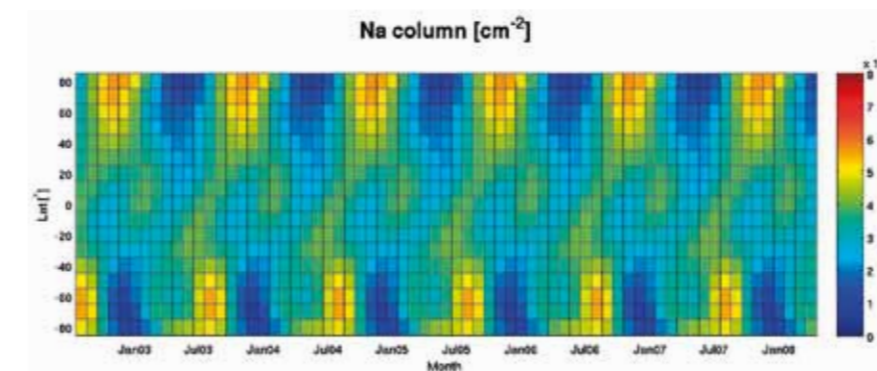

GOMOS sodium climatology: notice the semi-annual oscillation at the equator and the annual cycle in the Polar Regions.

Selected References

Fussen, D., F. Vanhellemont, J. Dodion, C. Bingen, N. Mateshvili, F. Daerden, D. Fonteyn, Q. Errera, S. Chabrilat, E. Kirölä, J. Tamminen, V. Sofieva, A. Hauchecorne, F. Dalaudier, J.-L. Bertaux, J.-B. Renard, R. Fraise, O. Fanton d'Andon, G. Barrot, M. Guirlet, A. Mangin, T. Fehr, P. Snoeij and L. Saavedra (2006), A global OCIO stratospheric layer discovered in GOMOS stellar occultation measurements, *Geophysical Research Letters*, 33(13), L13815, doi:10.1029/2006GL026406.

Fussen, D., F. Vanhellemont, C. Tétard, N. Mateshvili, E. Dekemper, N. Loodts, C. Bingen, E. Kyrölä, J. Tamminen, V. Sofieva, A. Hauchecorne, F. Dalaudier, J.-L. Bertaux, G. Barrot, L. Blanot, O. Fanton d'Andon, T. Fehr, L. Saavedra, T. Yuan and C.-Y. She (2010), A global climatology of the mesospheric sodium layer from GOMOS data during the 2002–2008 period, *Atmospheric Chemistry and Physics*, 10(19), 9225–9236, doi:10.5194/acp-10-9225-2010.

Tétard, C., D. Fussen, F. Vanhellemont, C. Bingen, E. Dekemper, N. Mateshvili, D. Pieroux, C. Robert, E. Kyrölä, J. Tamminen, V. Sofieva, A. Hauchecorne, F. Dalaudier, J. L. Bertaux, O. Fanton d'Andon, G. Barrot, L. Blanot, A. Dehn and L. Saavedra de Miguel (2013), OCIO slant column densities derived from GOMOS averaged transmittance measurements, *Atmospheric Measurement Techniques*, 6(11), 2953–2964, doi:10.5194/amt-6-2953-2013.

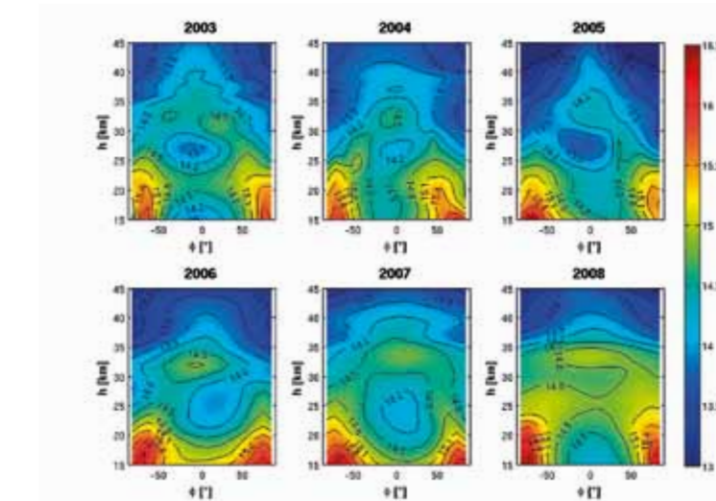

OCIO climatology produced by GOMOS data, confirming our discovery of an OCIO layer in the equatorial mid-stratosphere. OCIO slant column densities (log scale, cm^{-2}) are represented in latitude (Φ from 80°S–80°N) versus altitude (15–45 km) maps.

Website

GOMOS instrument page at ESA:
<https://earth.esa.int/web/guest/missions/esa-operational-eo-missions/envisat/instruments/gomos>

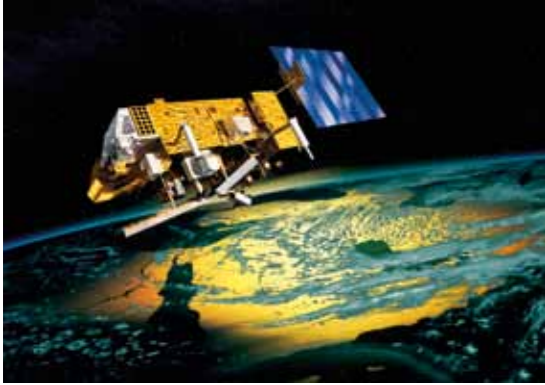

Artist impression of the GOME-2 instrument flying on board of the EUMETSAT MetOp-A platform. (credit: ESA)

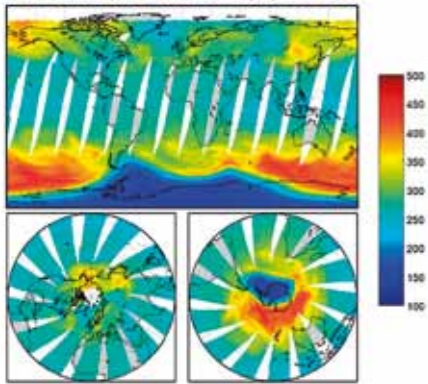

Worldwide map (on the top) and Arctic and Antarctic maps of total ozone product generated from GOME-2/ESA Ozone CCI project on 18 October 2007. The algorithm developed at BIRA-IASB has been applied to the successive GOME, SCIAMACHY, GOME-2 and OMI sensors to generate an ozone climate data record covering the period from July 1995 until 2014. (credits: ESA, EUMETSAT, CCI)

THE GLOBAL OZONE MONITORING EXPERIMENT-2 ON BOARD METOP: GLOBAL MONITORING OF TOTAL OZONE AND THE TROPOSPHERIC COMPOSITION

Michel Van Roozendael

With contributions from Isabelle De Smedt, Christophe Lerot, Gaia Pinardi and Nicolas Theys

Launched in October 2006 on board the MetOp-A platform, the Global Ozone Monitoring Experiment-2 (GOME-2) continues the long-term monitoring of atmospheric trace gases started by ERS-2 GOME in 1995 and continued with SCIAMACHY on the ENVISAT platform. GOME-2, of which three versions are planned for operation until 2020, flies on a Sun-synchronous polar orbit crossing the equator at 09:30 local time. It consists of a nadir-scanning UV-visible spectrometer covering the spectral range from 240 and 790 nm in four channels at a spectral resolution of 0.25-0.5 nm. The default swath width is 1920 km, which allows for global Earth coverage within 1.5 days at the equator with a nominal ground pixel size of 80×40 km².

GOME-2 measures the solar radiation backscattered by the atmosphere and reflected from the earth surface to infer, by means of the DOAS method, global maps of atmospheric ozone (O₃) as well as a number of key atmospheric trace gases such as nitrogen dioxide (NO₂), sulphur dioxide (SO₂) and formaldehyde (HCHO). It also provides useful information on aerosols, clouds and surface ultraviolet radiation.

BIRA-IASB has been involved in the exploitation of GOME-2 measurements since the start of the mission in 2006. Ongoing activities include the development of state-of-the-art retrieval algorithms for different species such as O₃, NO₂, SO₂, HCHO, glyoxal and BrO as well as an important contribution to the calibration-validation programme of MetOp. The latter relies on ground-based instruments operated by BIRA-IASB and deployed in international networks such as the Network for the Detection of Atmospheric Composition Changes (NDACC). The institute is a key partner of the EUMETSAT Satellite Application Facility on Ozone Monitoring (O₃MSAF) where it provides support to the development and continuous operational processing of GOME-2 data products. It is also member of the GOME Science Advisory Group and participates in a number of research projects exploiting GOME-2 data.

One key achievement of the team has been to provide the baseline algorithm used for operational processing of total ozone from the series of European sensors GOME, SCIAMACHY, GOME-2, and OMI. In this context, BIRA-IASB coordinates research activities related to the ozone climate data record developed as part of the ESA Climate Change Initiative programme (the Ozone CCI project).

Another important focus is the study of the tropospheric composition in support of air quality studies, e.g. in China where the strong and rapid growth of the economy and industrialization has been the source of major changes recently. Based on high-quality data products generated from multiple sensors including GOME-2, long-term trends in pollutants can be derived and their repartition assessed at the global scale. Our global data sets of formaldehyde, glyoxal, SO₂ and NO₂ columns are used in many projects, e.g. in support of inverse modelling studies of emissions, which represent a key input for the modelling of global and regional air quality.

GOME-2 also addresses the study of volcanic emissions. Satellite measurements by GOME-2 were even the first to detect volcanic BrO. On this topic, our interest extends from research to scientific service activities which are developed within SACS, the Support to Aviation Control Service (see chapter 14). SACS aims at making optimal use of current satellite sensors to detect and inform in near real-time on volcanic ash and SO₂ emissions. Main users are Volcanic Ash Advisory Centers (VAACs) which are responsible for coordinating and disseminating information on atmospheric volcanic ash clouds that may endanger aviation.

Until now, the GOME-2 team at BIRA-IASB has published about 15 papers in peer-reviewed international journals. The expertise demonstrated on the exploitation of GOME-2 and similar precursor instruments will be further developed in the future through our involvement in the ESA-EUMETSAT Sentinel programme, more specifically Sentinel-5 Precursor which is planned for launch in early 2016.

Selected References

De Smedt, I., M. Van Roozendael, T. Stavrou, J.-F. Müller, C. Lerot, N. Theys, P. J. M. Valks, N. Hao and R. van der A (2012), Improved De Smedt, I., M. Van Roozendael, T. Stavrou, J.-F. Müller, C. Lerot, N. Theys, P. J. M. Valks, N. Hao and R. van der A (2012), Improved retrieval of global tropospheric formaldehyde columns from GOME-2/MetOp-A addressing noise reduction and instrumental degradation issues, *Atmospheric Measurement Techniques*, 5(11), 2933-2949, doi:10.5194/amt-5-2933-2012.

Lerot, C., T. Stavrou, I. De Smedt, J.-F. Müller and M. Van Roozendael (2010), Glyoxal vertical columns from GOME-2 backscattered light measurements and comparisons with a global model, *Atmospheric Chemistry and Physics*, 10(24), 12059-12072, doi:10.5194/acp-10-12059-2010.

Theys, N., I. De Smedt, M. Van Roozendael, L. Froidevaux, L. Clarisse and F. Hendrick (2014), First satellite detection of volcanic OCIO after the eruption of Puyehue-Cordón Caulle, *Geophysical Research Letters*, 41(2), 667-672, doi:10.1002/2013GL058416.

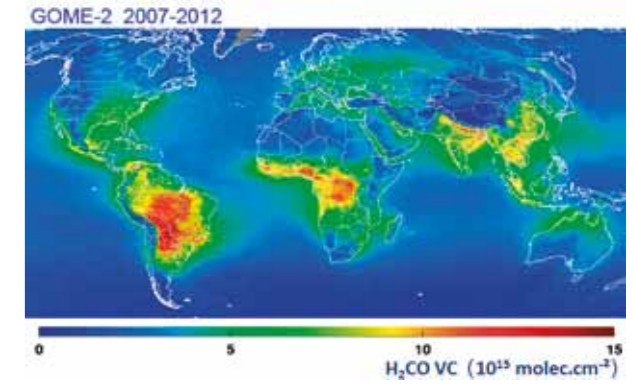

Long-term average of the global formaldehyde (HCHO) column derived at BIRA-IASB using the GOME-2 instrument. Hot spots are related to biogenic and anthropogenic emissions of non-methane volatile organic compounds. The strength of these emissions can be quantified from HCHO observations using inverse modelling approaches.

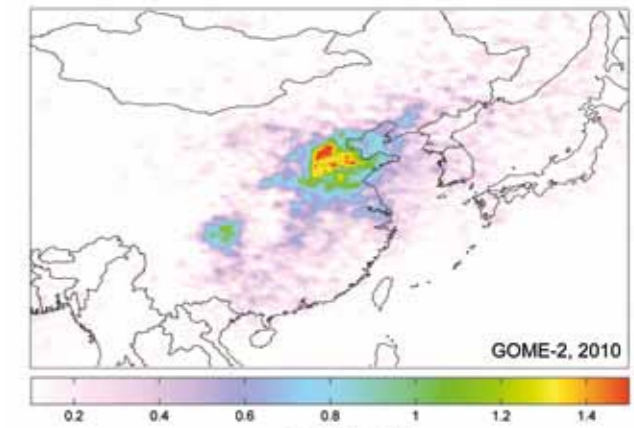

Yearly averaged SO₂ columns over Northeast China as derived at BIRA-IASB from GOME-2 observations in 2010. Strong SO₂ emissions in this region of the world are mostly due to the burning of coal in power plants and industry.

Websites

EUMETSAT O3MSAF: <http://o3msaf.fmi.fi/>
SACS: <http://sacs.aeronomie.be/>

Ozone CCI Project: <http://www.esa-ozone-cci.org/>
TEMIS: www.temis.nl



The IASI instrument. (credit: Thales Alenia Space)

THE INFRARED ATMOSPHERIC SOUNDING INTERFEROMETER

Sophie Vandebussche and Evelyn De Wachter

The **Infrared Atmospheric Sounding Interferometer (IASI)** has been developed by CNES in cooperation with the European Organisation for the Exploitation of Meteorological Satellites (EUMETSAT). This instrument is flying on board the MetOp-A and B satellite platforms since October 2006 and September 2012 respectively, on Sun-synchronous polar orbits (about 800 km altitude) crossing the equator at about 9h30 and 10h20 respectively, local solar time. IASI is a Fourier Transform Spectrometer (Michelson Interferometer) pointing at the Earth's nadir and measuring in a large spectral range (3.7 - 15.5 μm) the thermal radiation emitted by the Earth and its atmosphere, and part of the Earth reflection of the solar infrared radiation reflected by the Earth. This type of instrument allows obtaining data during both day and night, which is a non-negligible advantage in terms of time coverage. This, together with the wide ground coverage of measurements for each orbit, allows to obtain almost global Earth coverage twice a day with each IASI instrument.

IASI has been designed for operational meteorological soundings (temperature and humidity vertical profiles with vertical resolution of 1 km) with a very high level of accuracy (1K and 10% respectively) to serve as initial state in weather forecast models. The accuracy of forecasts highly depends on the accuracy of the initial state. Therefore, IASI measurements highly contribute to the improvement of forecasting, especially at medium range (3 to 10 day forecasts). As IASI data are used operationally in most weather forecast centres worldwide, in both global and fine-scale models, its impact on the forecast quality is the greatest of all weather forecasting instruments currently used.

IASI is also designed for atmospheric chemistry aiming at estimating and monitoring trace gases on a global scale. Its excellent radiometric performance can be used to obtain the vertical composition or the integrated column of some 20 trace gases, in particular ozone and carbon monoxide. In addition, species that were believed to be undetectable from space, such as ammonia, have been found in IASI spectra. IASI data may therefore be used to detect certain events such as biomass burning plumes.

IASI spectra are also used to retrieve information on atmospheric aerosols (mainly desert dust, volcanic ash, ice clouds), which was not foreseen at the time of conception.

IASI instruments are extremely good candidates for long-term and climate studies, providing continuous data records for probably more than twenty years: the currently flying instruments are expected to provide together more than 14 years of thermal infrared radiance, and will be followed by a third identical instrument in

2016-2017 and new generation instruments with enhanced properties (better signal-to-noise ratio and better resolution) from 2020 onwards. Furthermore, this instrument has an exceptional spectral and radiometric stability. This allows long-term monitoring of everything that might be retrieved from IASI measurements, i.e. temperature, humidity, trace gases, clouds, aerosols, surface properties, ...

The interest of the scientific community in the use and application of IASI spectra is still growing, with a lot of ongoing research in all area described above: further improvements of the temperature and water vapour vertical profiles (especially in cloudy conditions and above continental surfaces), improvements in the current trace gas retrievals and development of retrieval strategies for new species including aerosols, exploitation of synergies with other instruments, ...

At BIRA-IASB we focus on two applications: the retrieval of vertical profiles of greenhouse gases (in particular methane, CH_4 , and nitrous oxide, N_2O) and of aerosols (mainly dust and ash) in the troposphere (see chapter 12).

Methane, being the second most important long-lived greenhouse gas, is produced at the surface by both natural (wetlands, termites, geological sources, ...) and anthropogenic (rice agriculture, ruminants, mining, ...) processes. It has a long lifetime of about 10 years. The latest greenhouse gas bulletin (November 2013) of the World Meteorological Organisation (WMO) Global Atmosphere Watch (GAW) programme reported globally averaged CH_4 concentrations in 2012 equivalent to ~260% of pre-industrial (before 1750) levels (1819 ± 1 ppb versus pre-industrial values of ~700 ppb). Despite the recognized importance of an accurate understanding of the CH_4 budget, there are still gaps in our knowledge of its sources and sinks.

The BIRA-IASB team works on the delivery of scientific data products of CH_4 from the IASI instrument, with a special focus on improving the sensitivity of the retrieval in the lowermost layers of the atmosphere, as close as possible to the associated sources of CH_4 . Future work will include the retrieval of nitrous oxide from IASI spectra and the retrieval of methane from spectral data from the Japanese "Thermal And Near infrared Sensor for carbon Observation - Fourier Transform Spectrometer" (TANSO-FTS) instrument on board the "Greenhouse gases Observing SATellite" (GOSAT) launched in January 2009.

Selected References

Hilton, F.I., T. August, C. Barnet, A. Bouchard, C. Camy-Peyret, L. Clarisse, C. Clerbaux, P.-F. Coheur, A. Collard, C. Crevoisier, G. Dufour, D. Edwards, F. Fajjan, N. Fourrié, A. Gambacorta, S. Gauguin, V. Guidard, D. Hurtmans, S. Illingworth, N. Jacquinet-Husson, T. Kerzenmacher, D. Klaes, L. Lavanant, G. Masiello, M. Matricardi, T. McNally, S. Newman, E. Pavelin, E. Péquignot, T. Phulpin, J. Remedios, P. Schlüssel, C. Serio, L. Strow, J. Taylor, D. Tobin, A. Uspensky and D. Zhou (2012), Hyperspectral Earth Observation from IASI: five years of accomplishments, *Bulletin of the American Meteorological Society*, 93(3), 347-370, doi:10.1175/BAMS-D-11-00027.1.

Kerzenmacher, T., B. Dils, N. Kumps, T. Blumenstock, C. Clerbaux, P.-F. Coheur, P. Demoulin, O. Garcia, M. George, D.W. Griffith, F. Hase, J. Hadji-Lazaro, D. Hurtmans, N. B. Jones, E. Mahieu, J. Notholt, C. Paton-Walsh, U. Raffalski, T. Ridder, M. Schneider, C. Servais and M. De Mazière (2012), Validation of IASI FORLI carbon monoxide retrievals using FTIR data from NDACC, *Atmospheric Measurement Techniques*, 5(11), 2751-2761, doi:10.5194/amt-5-2751-2012.

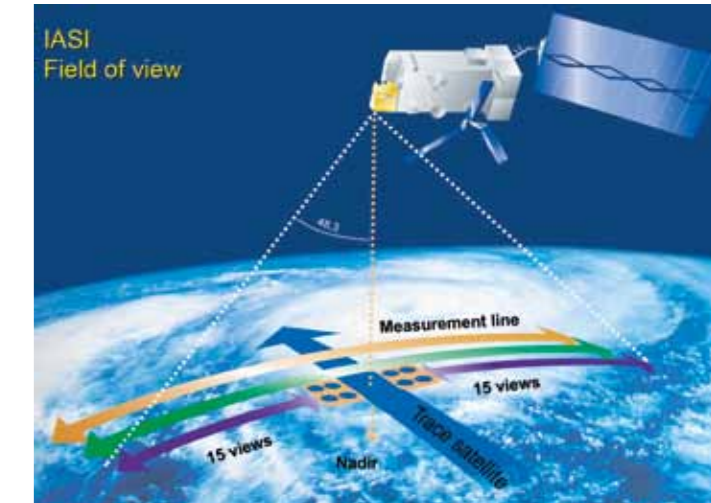

IASI ground coverage of measurements. (credit: CNES)

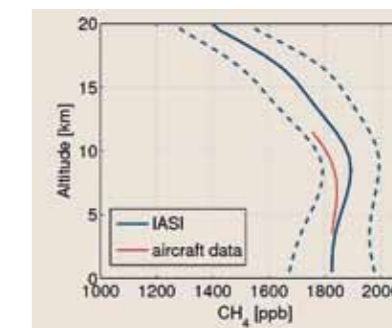

Typical methane profile retrieved from IASI spectra (blue) and the total retrieval error (dashed blue lines) compared to aircraft data (red).

Websites

IASI Official Website:
<http://smc.cnes.fr/IASI/>

WMO Greenhouse Gas Bulletin:
<http://www.wmo.int/pages/prog/arep/gaw/ghg/GHGbulletin.html>



The ESA's Cluster mission consists of four identical spacecraft flying in formation between 19000 and 119000 km above the Earth. They study the interaction between the solar wind and Earth's magnetosphere, or the Sun-Earth connection in 3D. (Credit ESA)

MULTI-SPACECRAFT EXPLORATION OF THE MAGNETOSPHERE WITH CLUSTER

Johan De Keyser

Magnetospheric plasmas are very tenuous, so that they are hard to image with remote sensing instruments. Also the fields cannot be remotely detected. Therefore one has to rely on in situ measurements. The difficulty is that a spacecraft measures a quantity at one point in space and at a specific time. If one observes variations of that quantity, it is never clear whether this is due to spatial structure or due to time variations. To disambiguate between these different interpretations, it is essential to measure the same quantity simultaneously at four non-coplanar points. This is the basic idea behind ESA's Cluster mission: a constellation of four identical spacecraft. The idea was first proposed in 1982. In 1996, Cluster was ready to be launched on the maiden flight of the Ariane 5 booster. Unfortunately, the launcher failed and broke up after initiation of the automatic destruct system. Because of its scientific importance, Cluster had been considered to be a cornerstone of ESA's science programme. There was a strong determination to rebuild the mission. It was launched two at a time on two successive Soyuz launches in 2000. The four-point measurements have already yielded new insights into space plasma processes in the magnetosphere.

BIRA-IASB has not contributed to the construction of the spacecraft or the payloads, but it was involved in the scientific teams from the start, in particular with a Co-Investigatorship in the WHISPER and STAFF experiments. Because the Institute was not so much associated with a specific instrument, the research has often be directed towards interdisciplinary work, combining data from various instruments.

The Institute has done a lot of work on the development of multi-spacecraft data interpretation techniques. A first such interpretation technique is the so-called empirical reconstruction technique for examining the structure of the magnetopause and low-latitude boundary layer. We started developing this technique before the Cluster era, with data from the single-spacecraft AMPTE/IRM mission, but its potential is much bigger with multi-spacecraft data. Empirical reconstruction assumes that the magnetopause has a fixed structure but is moving all the time; the motion and the profiles of density, temperature, magnetic field, etc. are determined by trying to match the observations. This has given some insights on the structure of the low-latitude boundary layer. This reconstruction technique has been extended to 2-dimensional structures. In particular, it has become possible to obtain the geometry of periodic surface waves on the magnetopause.

Another technique invented at BIRA-IASB is least-squares gradient computation (LSGC). The technique generalises the standard Cluster gradient tool, which simply estimates the gradients from differencing four simultaneous observations. LSGC has an interesting science potential and it is still being developed further.

A lot of Cluster work has focused on the plasmasphere, a research domain in which BIRA-IASB historically has been very active. On the one hand, there is the more observational work, which has had to rely on the WHISPER data to obtain correct density measurements of the plasmaspheric density (because the plasma is too cold, the mass spectrometers are of little use here). Various structures in the plasmasphere (such as plasmaspheric plumes) have been examined in detail by using the Cluster gradient tool. On the other hand we have built a semi-empirical plasmasphere model to explain the Cluster observations. Fortunately, NASA's IMAGE mission provided global data on the plasmasphere (mainly its EUV imager) that nicely complemented Cluster's in situ measurements. A major result was the publication of a book summarising the state-of-the-art, edited by BIRA-IASB scientists.

Auroral studies form a major part of the Cluster research. Cluster offers unparalleled opportunities for studying the high-altitude structures that are believed to be the generators of aurora. Such structures can be often modelled as tangential discontinuities. The BIRA-IASB team has a strong heritage in studying tangential discontinuities (dating back to studies of magnetopause structure with ISEE, and of solar wind discontinuities with Ulysses). The Cluster observations can thus be consistently interpreted. In addition, the team has worked on models of the auroral current circuit, which relate what happens at Cluster to the appearance of aurora in the ionosphere. The team has used data from low-altitude spacecraft (e.g. DMSP) and ground-based data (EISCAT radar, ALIS auroral camera network) to verify the correctness of such models.

Cluster has considerably increased our insight in how the magnetosphere works. The overall picture of mass transport in the magnetosphere begins to form. Our studies of the magnetospheric boundary indicate a source of plasma from the solar wind. Precipitating particles in aurora bring matter into the atmosphere. Solar UV and auroral precipitation heat up the upper atmosphere and produce outflows that Cluster can monitor, in particular by using O^+ as a tracer. Plasmaspheric plasma intermittently gets lost in the course of a substorm, while plasma sheet plasma is recirculated back. Cluster helps us to find several pieces of this mass transport puzzle.

AMPTE

Active Magnetospheric Particle Tracer Explorers. The mission was designed to study the access of solar-wind ions to the magnetosphere, the convective-diffusive transport and energization of magnetospheric particles, and the interactions of plasmas in space. It was launched in 1984. (Source: NASA)

WHISPER

Waves of High frequency and Sounder for Probing of Electron density by Relaxation experiment. Near-Earth space is populated by charged particles whose density governs wave generation and energy transfers.

To measure this fundamental quantity, WHISPER makes use of a resonance sounding (radar) technique. Brief radio pulses, sent out from two 50-metre-long wire antennas, trigger oscillations or 'echoes', which are detected after a short delay. Their frequencies reveal the particle concentration in the medium. In addition, WHISPER monitors natural wave activity in the frequency range (2 to 80 kHz) covered by the sounder. (Source: ESA)

STAFF

Spatio-Temporal Analysis of Field Fluctuation experiment. A magnetometer on the end of a five metre long boom looks at waves (rapid variations in the magnetic fields), particularly in regions where the charged particles of the solar wind interact with the magnetosphere. (Source: ESA)

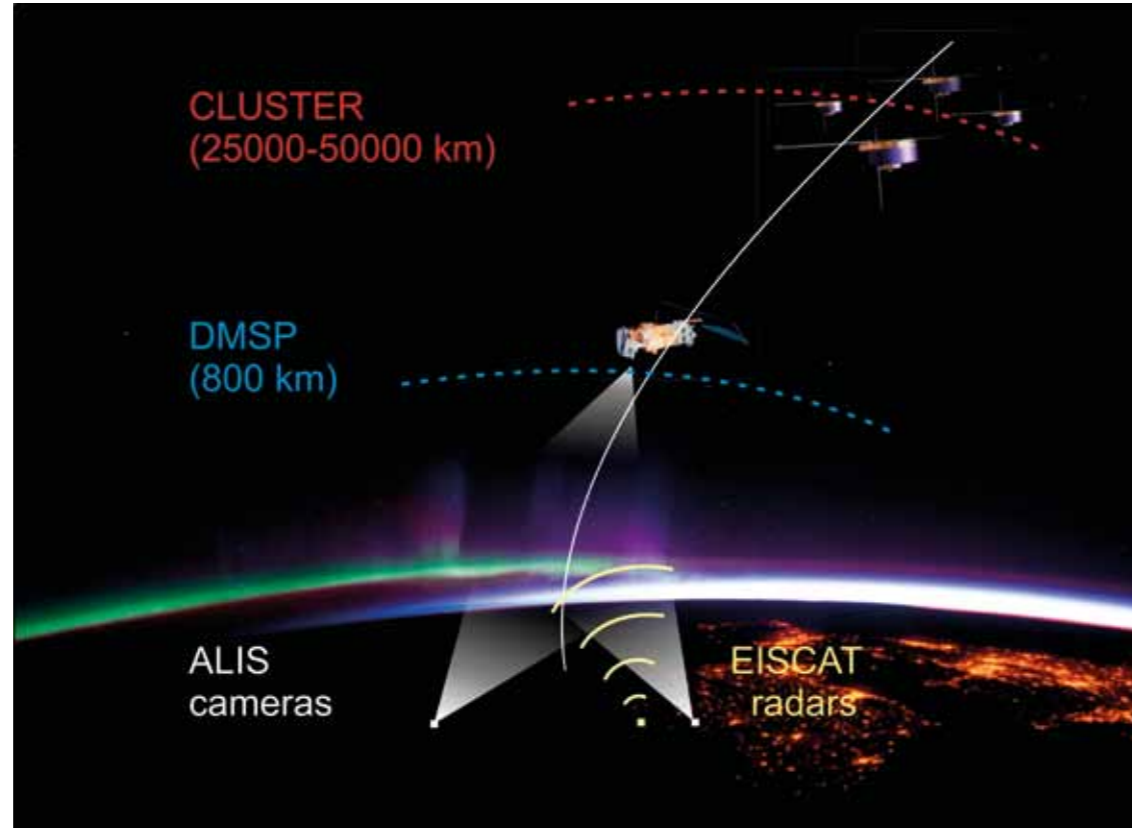

Studies of the auroral current circuit benefit from a combination of high-altitude spacecraft such as Cluster, low-altitude spacecraft, and ground-based observations. (credit : ESA-NASA)

Selected References

De Keyser, J. (2005), Least-squares multi-spacecraft gradient calculation with automatic error estimation, *Annales Geophysicae*, 26(11), 3295-3316, doi:10.5194/angeo-26-3295-2008.

De Keyser, J., M. Roth, M.W. Dunlop, H. Rème, C. J. Owen and G. Paschmann (2005), Empirical reconstruction and long-duration tracking of the magnetospheric boundary in single- and multi-spacecraft contexts, *Annales Geophysicae*, 23(4), 1355-1369, doi:10.5194/angeo-23-1355-2005

De Keyser, J., R. Maggiolo, M. Echim and I. Dandouras (2011), Wave signatures and electrostatic phenomena above aurora: Cluster observations and modeling, *Journal of Geophysical Research: Space Physics*, 116(A6), A06224, doi:10.1029/2010JA016004.

Maggiolo, R., M. Echim, C. Simon Wedlund, Y. Zhang, D. Fontaine, G. Lointier and J.-G. Trotignon (2012), Polar cap arcs from the magnetosphere to the ionosphere: kinetic modelling and observations by Cluster and TIMED, *Annales Geophysicae*, 30(2), 283-302, doi:10.5194/angeo-30-283-2012.

THE SOLAR SPECTRUM EXPERIMENT ON BOARD THE INTERNATIONAL SPACE STATION

David Bolsée and William Peetermans

The seventies were marked by the first solar irradiance measurements above the atmosphere. As developed in chapter 7, the Solar Spectrum (SOLSPEC) instrument contributed to these objectives with a series of short term missions on board the space shuttles SPACELAB 1, ATLAS 1, 2 and 3 for the measurement of ultraviolet and visible parts of the solar spectrum and one middle term mission on the satellite EURECA. The near infrared part of the solar spectrum was obtained from EURECA through the benefice of a better thermal environment for the hardware. After two decades of international collaborations, measurement campaigns and comparisons of quite accurate results from different instruments, the solar irradiance variability has been quantified. The data revealed different changes in terms of time scale and wavelength.

Actually, for modelling purposes of solar physics, climatology and atmospheric sciences, a new need for more accurate measurements over the whole solar spectrum popped up. This is a key input for these models since atmospheric processes such as photodissociation, ionisation, and absorption are wavelength dependent. An opportunity for a long term flight on the International Space Station (ISS), covering solar cycle #24 (the SOLAR mission) meant the start of a third life for SOLSPEC. SOLAR SOLSPEC is an updated version of an older instrument that already participated 5 times in space missions over the past 30 years (see chapter 7). Its first concept was developed at the end of the seventies.

The main purposes for the refurbishment of SOLSPEC, allowing to achieve the requirements for long term mission, were:

- to update the optics and electronics,
- to adapt the mechanical interface to the new requirements,
- to develop a reliable in-flight calibration procedure for maintaining the ability to detect short and long term variability of solar irradiance, and
- to perform efficient pre-flight absolute calibrations.

In collaboration with LATMOS, a robust SOLAR SOLSPEC instrument was developed, with renewed electronics, especially for the infrared channel which was largely improved, a new software for the acquisition, innovations and new technologies for the internal calibration lamps and filters. A new solar pointer was also implemented. BIRA-IASB played a key role for the development (e.g. mechanics and instrument software) and the radiometric characterisation of the new instrument. The accurate absolute calibration in front of

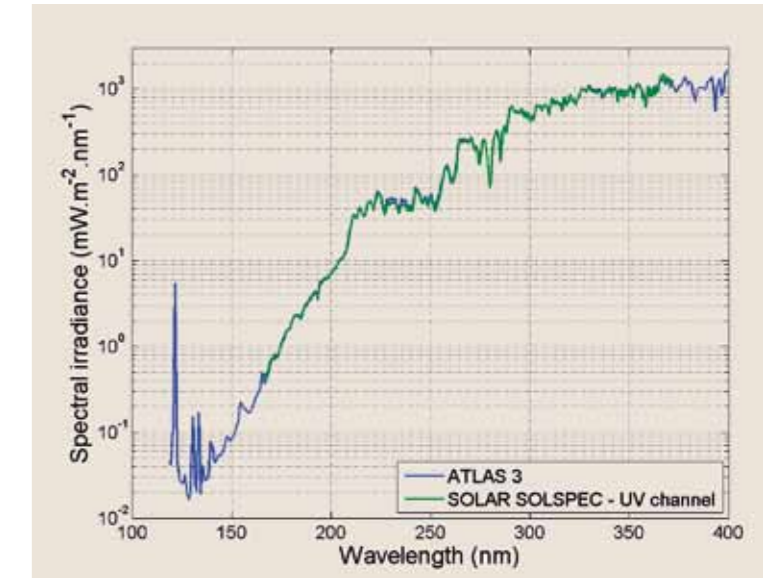

UV Solar spectral irradiance measured for quiet sun condition between the solar cycles 23 and 24 by the experiment SOLAR SOLSPEC (in green) - Comparison with ATLAS-3 (in blue).

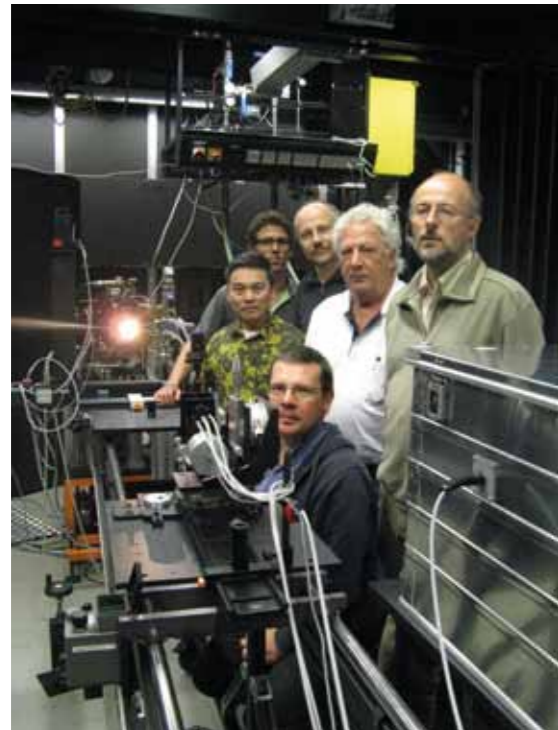

SOLSPEC blackbody calibration at the Physikalisch-Technische Bundesanstalt (PTB, Germany).

a primary standard of spectral irradiance was performed with a new partner, the Physikalisch-Technische Bundesanstalt (PTB, Germany), providing a black body 10 times more stable than in the past.

Finally, the delivered instrument had many improvements: extended operational spectral ranges (now from 166 to 3088 nm), a better spectral resolution and a better absolute calibration. SOLAR SOLSPEC was launched on 7 February 2008. The solar spectral irradiance has currently been measured for 6 years, with an uncertainty limited to 1 % between 500 nm and 1900 nm, < 2 % if the range 370 nm to 2350 nm is considered, around 4 % below 370 nm and from 2 to 10 % above 2350 nm, for the end of the IR channel. It confirmed the nominal operations of the new, well-calibrated UV channel from which the solar UV variability is actually extracted. For the NIR (near infrared) irradiance, SOLAR SOLSPEC is the only instrument able to measure in absolute radiometric unit above 2400 nm. Unusual NIR results obtained from the ISS SOLSPEC instrument were found with respect to the EURECA mission but a validation campaign helped us to confirm the data acquired in orbit. The mission is currently extended until end of 2017.



SOLSPEC (at the centre with the four holes) integrated in the SOLAR platform mounted on the exterior of the European Columbus module of the International Space Station (ISS). (credit: ESA/NASA)

Selected References

Thuillier, G., T. Foujols, D. Bolsée, D. Gillotay, M. Hersé, W. Peetermans, W. Decuyper, H. Mandel, P. Sperfeld, S. Pape, D. R. Taubert, J. Hartmann (2009), SOLAR/SOLSPEC: Scientific Objectives, Instrument Performance and Its Absolute Calibration Using a Blackbody as Primary Standard Source, *Solar Physics*, 257(1), 185-213, doi:10.1007/s11207-009-9361-6.

Thuillier, G., M. DeLand, A. Shapiro, W. Schmutz, D. Bolsée, S. M. L. Melo (2012), The Solar Spectral Irradiance as a Function of the Mg II Index for Atmosphere and Climate Modelling, *Solar Physics*, 277(2), 245-266, doi:10.1007/s11207-011-9912-5.

Bolsée, D., N. Pereira, W. Decuyper, D. Gillotay, H. Yu, P. Sperfeld, S. Pape, E. Cuevas, A. Redondas, Y. Hernández, and M. Weber (2014), Accurate Determination of the TOA Solar Spectral NIR Irradiance Using a Primary Standard Source and the Bouguer–Langley Technique, *Solar Physics*, 289(7), 2433-2457, doi:10.1007/s11207-014-0474-1.

THE ATMOSPHERIC CHEMISTRY EXPERIMENT

Martine De Mazière and Didier Fussen

With contributions from Jean-Christopher Lambert, François Hendrick and Filip Vanhellemont

The **Atmospheric Chemistry Experiment (ACE)** is a satellite mission designed to investigate chemical and dynamical processes in our atmosphere, with a particular emphasis on ozone depletion in the Arctic stratosphere. ACE was launched on August 12, 2003, on board of the Canadian satellite SCISAT-1 into a 74° inclination orbit. This orbit inclination is the best compromise to achieve numerous types of measurements, global coverage, as well as high latitude coverage. SCISAT-1 was originally designed for a 2-year mission but has now surpassed expectations and continues to record measurements of the Earth's atmosphere. In 2013, SCISAT-1 celebrated its 10th anniversary in orbit. To commemorate this special occasion, a tenth anniversary book has been published entitled *The Atmospheric Chemistry Experiment ACE at 10: A Solar Occultation Anthology*.

The scientific payload of ACE consists of two main instruments: ACE-FTS and MAESTRO. Both instruments are designed to measure the vertical and geographical distribution of dozens of chemicals interacting with the ozone layer and with climate change.

ACE-FTS, the prime scientific instrument on SCISAT-1, is a high spectral resolution (0.02 cm^{-1}) Fourier Transform Spectrometer (FTS). This FTS is based on a Michelson interferometer operating from 2.2 to $13.3 \mu\text{m}$, that was custom designed and built by ABB-Bomem in Quebec City. Belgium contributed to the ACE-FTS instrument with two filtered imagers at 0.525 and $1.02 \mu\text{m}$, chosen such that they match two of the wavelengths monitored by the SAGE II occultation radiometer. The imagers provide an important calibration tool for pointing registration and for detecting the presence of clouds in the field of view. Their detectors are filtered CMOS arrays, binned into 128×128 active pixels, designed and built by Fill Factory in Mechelen, Belgium.

MAESTRO (Measurement of Aerosol Extinction in the Stratosphere and Troposphere Retrieved by Occultation) is a small spectrophotometer designed and built in a partnership among the Meteorological Service of Canada (MSC), the University of Toronto, and EMS Technologies in Ottawa. The instrument consists of two spectrographs (280-550 nm, 500-1030 nm) to reduce straylight and to enable simultaneous measurements of the two bands with a spectral resolution of 1-2 nm.

Belgian scientists from BIRA-IASB, the “Université de Liège” (ULg) and the “Université Libre de Bruxelles” (ULB) got involved in the ACE Science Team in 1998 when the Principal Investigator Peter Bernath from the

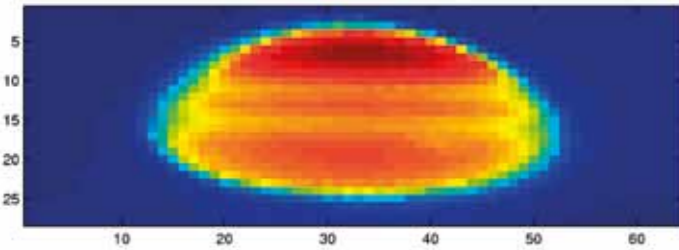
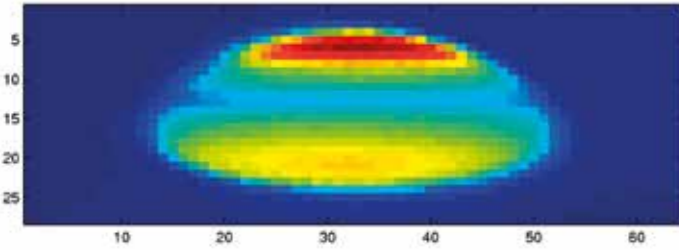

Examples of imager data at $1.02 \mu\text{m}$ where the solar disk is flattened by atmospheric refraction and traversed by two kinds of polar stratospheric clouds (top: unimodal layer bottom: bimodal layer).

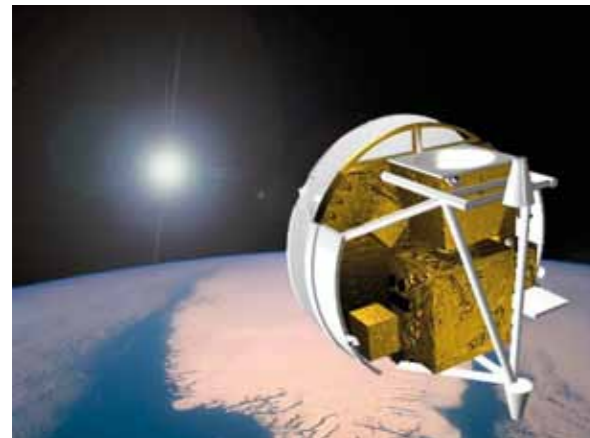

ACE in orbit above the Earth.
(credit: Canadian Space Agency)

Website

ACE:
<http://www.ace.uwaterloo.ca>

Department of Chemistry at the University of Waterloo in Canada, was preparing the proposal for the mission and visited his colleague, Prof. Reginald Colin, at ULB. They have participated to the definition of the mission, the generation of new data products, and the geophysical validation of the data.

BIRA-IASB scientists have made important contributions to the exploitation of the ACE-FTS imagers and to the geophysical validation of several ACE-FTS and MAESTRO data products, by delivering correlative data from their ground-based observations in NDACC and from other satellite experiments like GOMOS. In particular they have coordinated validation efforts for ACE-FTS temperature and methane profiles, and for MAESTRO NO_2 profiles. The initial validation results, including many contributions from BIRA scientists, have been published in a special issue in *Atmospheric Chemistry & Physics* in 2008.

Among the major achievements of ACE, one can cite

- time series of the vertical distribution from the upper troposphere to the lower mesosphere for a vast number of atmospheric molecules, including isotopes, as well as polar stratospheric and mesospheric clouds and aerosols,
- a quality controlled climatology for each of the 14 baseline species for ACE-FTS (O_3 , H_2O , CH_4 , N_2O , CO , NO , NO_2 , N_2O_5 , HNO_3 , HCl , ClONO_2 , CCl_3F , CCl_2F_2 , and HF), as well as a combined NO_y climatology from the NO , NO_2 , N_2O_5 , ClONO_2 , HNO_3 , and HNO_4 (research product) results,
- a new solar atlas,
- ACE Infrared Spectral Atlases of the Earth's Atmosphere, submitted to *Journal of Quantitative Spectroscopy and Radiative Transfer* in 2014.

Hopefully, the ACE experiment can still be operational for several years to come, as no serious degradation has been observed so far for ACE-FTS. Today, in 2014, after the loss of UARS and SAGE-II in 2005 and Envisat in 2012, ACE-FTS is one of the very few satellite experiments still alive that deliver vertical profile information in the stratosphere and upper troposphere.

Selected References

Dodion, J., D. Fussen, F. Vanhellemont, C. Bingen, N. Matshvili, K. Gilbert, R. Skelton, D. Turnbull, S. D. McLeod, C. D. Boone, K. A. Walker and P. F. Bernath (2007), Cloud detection in the upper troposphere-lower stratosphere region via ACE imagers: A qualitative study, *Journal of Geophysical Research: Atmospheres*, 112(D3), D03208, doi:10.1029/2006JD007160.

THE ENERGETIC PARTICLE TELESCOPE INSTRUMENT

Viviane Pierrard and Ghislain Grégoire (UCL)

Introduction

The Sun emits particles (mainly protons and electrons) in all directions to the interplanetary space. This flux of particles is called the solar wind. The Earth is protected from these particles by its magnetic field. Some energetic particles (from KeV to hundreds of MeV) are trapped in the radiation belts located typically between 1.2 and 8 Earth radii. Some energetic particles precipitate also into the Earth atmosphere in the high latitude regions and create auroras. The solar particle fluxes can generate magnetic storms disturbing electric and electronic devices useful for the human activities like satellite instruments, communications, airplane electronics, etc.

Goals of EPT

It is thus essential to characterize these fluxes of space particles in different ways: identify the particle species, measure their number density, their energy, their direction... and so contribute to space weather. This is the goal of the EPT (Energetic Particle Telescope) instrument. The design of this instrument results from a fruitful collaboration between BIRA-IASB and UCL. The space physics team at BIRA-IASB develops models for the solar wind and radiation belts using observations made by detectors on board spacecraft, the nuclear physics team of UCL builds and uses such detectors for different purposes. That is why, since 1994, it appeared desirable to put this experience in common and share the resources to design, build and realize this EPT.

History

A research centre called the "Center for Space Radiations" (CSR) was created in UCL in 2003 with co-direction by BIRA-IASB and UCL. A consortium was developed between UCL, BIRA-IASB and QinetiQ Space to create the EPT instrument with the support of ESA and Belpo under GSTP contracts. The CSR team coordinated the EPT project for the design of the instrument. The engineering team at BIRA-IASB took care of the mechanical aspects, while its space physics team ensures the scientific aspects and its B.USOC team and the control centre in Redu took care of the data transmission and operational services. The QinetiQ Space private company took care of the electronics of the instrument and its integration on the PROBA-V satellite (PROject for On Board Autonomy-Vegetation). This Belgian satellite, including also other instruments for the observation of the Earth's vegetation, was launched on 7 May 2013 on a Vega rocket. The satellite circulates on a Sun-synchronized polar orbit at 820 km of altitude so that the EPT instrument can measure the particle fluxes of energetic electrons, protons and other ions of the low altitude radiation belts.



The ESA satellite PROBA-V with the instrument EPT.
(credit ESA)

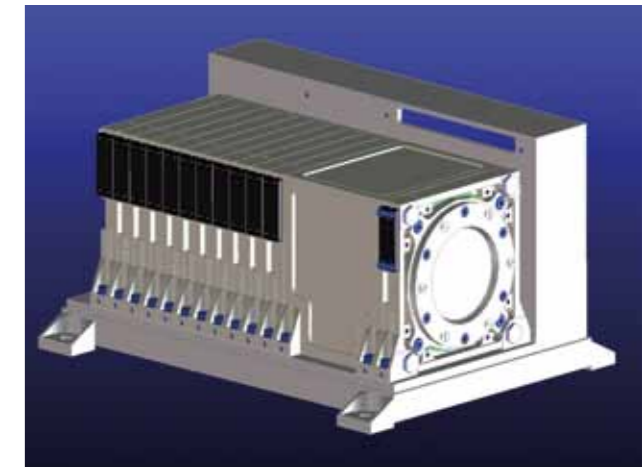

The EPT instrument.

Alpha particle

A particle which consist of two protons and two neutrons bound together into a particle identical to a helium nucleus.

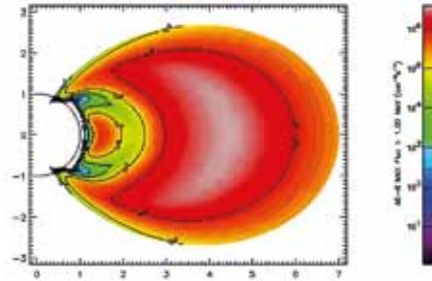

Electron flux (> 1 MeV) in Van Allen radiation belts as obtained with the empirical NASA model AE8 (www.spennis.oma.be).

Van Allen

James A. Van Allen (1914 - 2006): American space scientist of the University of Iowa who discovered in 1958 the Van Allen radiation belts (named after him) with a Geiger instrument on board the American satellite Explorer I.

South Atlantic Anomaly

This is the area where the Earth's inner Van Allen radiation belt comes closest to the Earth's surface dipping down to an altitude of 200 km.

Functioning Principles

The EPT is based on the following principles: a charged particle penetrates deeper in a material when its kinetic energy is very high. Moreover, the penetration depth also depends on the nature of this projectile: an electron, a proton and an alpha particle with the same energy will penetrate with decreasing depths in a given material. The energy deposited by unit length will increase from the electron to the alpha. This explains why, for a given particle, the measurement of the penetration distance in the absorption material gives an indication on the initial energy of this particle.

Telescope

The EPT instrument includes a low energy section, consisting of two silicon detectors placed at the instrument entrance, and a high energy section, composed of 10 so-called Digital and Absorber Modules (DAM), each of these comprising an absorber material and a silicon sensor. A fully operational EPT has the size of a small shoe box, weighs a few kg and requires 4 W of electric energy.

The measurement of the penetration distance is obtained by counting the number of detectors that gave a signal or more precisely by registering the so-produced binary number. We then know that the energy of the particle is included in a specific energy range called channel.

The electronic treatment of the signal on board the satellite is then simply to register the number of hit detectors, corresponding to the energy of each incident particle. The conversion of this binary number to energy is known by the calibrations realized with particle accelerators on the ground before the launch.

Conclusion and Perspectives

The EPT instrument measures the high energy fluxes of 0.2-10 MeV electrons, 4-300 MeV protons and 10-1000 MeV He ions in the space radiation belts. It measures the energy deposited by charged particles into modular sensitive elements placed in series and provides the high-energy particle fluxes with very good energy, angular and mass resolutions. These characteristics allow us to improve our analyses of spectra in the Van Allen radiation belts. The first results of data analysis show electron, proton and helium ion fluxes in the South Atlantic Anomaly and at high latitudes, with high flux increases during Solar Energetic Particle events. Due to the widely varying fluxes of electrons, protons and heavy ions within the radiation belts, the instrument has a stunning in-flight particle discrimination capability that provides more precise measurements than those made by previous detectors. The energy ranges, size and mass of the instrument can be modulated depending on the orbit of the future missions. An instrument based on the EPT-technologies to detect the angular direction of electrons (called 3DEES) is also in development.

Selected References

Cyamukungu M., C. Lippens, L. Adams, R. Nickson, C. Boeder, V. Pierrard, E. Daly, G. Grégoire and J. Lemaire (1999), Magnetic storm acceleration of radiation belt electrons observed by the Scintillating Fibre Detector (SFD) onboard EQUATOR-S, *Annales Geophysicae*, 17(12), 1622-1625, doi:10.1007/s00585-999-1622-z.

Heynderickx, D., M. Kruglanski, V. Pierrard, J. Lemaire, M. D. Looper and J. B. Blake (1999), A low altitude trapped proton model for solar minimum conditions based on SAMPEX/PET data, *IEEE Transactions on Nuclear Science*, 46(6), 1475-1480, doi:10.1109/23.819110.

Pierrard, V. and J. Lemaire (1996), Fitting the AE-8 energy spectra with two Maxwellian functions, *Radiation Measurements*, 26(3), 333-337, doi:10.1016/1350-4487(96)00057-1.

Pierrard, V., J. Lemaire, D. Heynderickx, M. Kruglanski, M. Looper, B. Blake and D. Mewaldt (2000), Statistical analysis of SAMPEX PET proton measurements, *Nuclear Instruments and Methods in Physics Research Section A: Accelerators, Spectrometers, Detectors and Associated Equipment*, 449(1-2), 378-382, doi:10.1016/S0168-9002(99)01454-0.

Pierrard, V. and K. Borremans (2012), Fitting the AP-8 spectra to determine the proton momentum distribution functions in space radiations, *Radiation Measurements*, 47(6), 401-405, doi:10.1016/j.radmeas.2012.04.002.

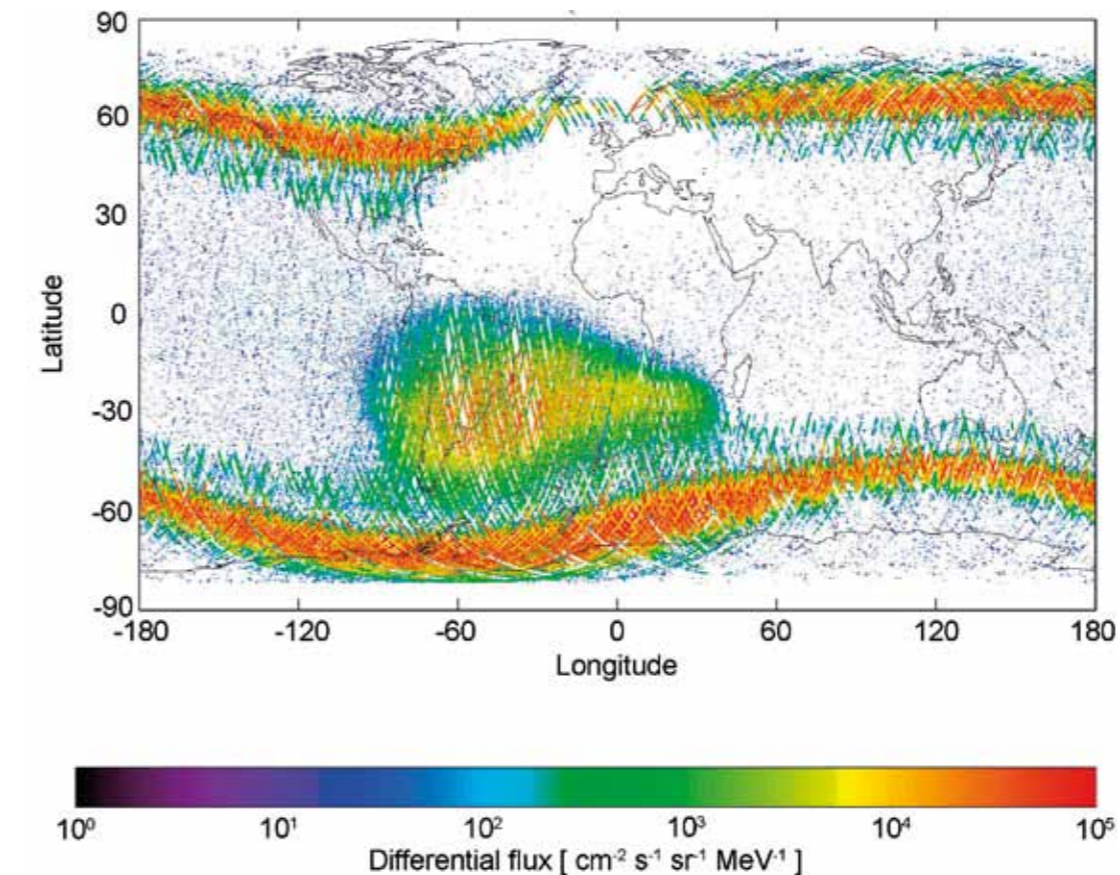

Electron flux measured by the EPT instrument at an altitude of 820 km in the energy range 500 to 600 keV during June 2013. One can see the South Atlantic Anomaly as well as the penetration of the outer belt at high latitudes.

[Website](http://ept.aeronomie.be)

EPT:
<http://ept.aeronomie.be>

THE ATMOSPHERIC LIMB TRACKER FOR THE INVESTIGATION OF THE UPCOMING STRATOSPHERE MISSION: THE FIRST BELGIAN SOUNDER OF THE EARTH ATMOSPHERE

Didier Fussen, Emmanuel Dekemper, Didier Peroux and Filip Vanhellemont
With contributions from Nina Mateshvili

It is now accepted that the global and polar depletions of the ozone layer can be attributed to the presence of halogen compounds released by anthropogenic emissions. The Montreal protocol has allowed observing a decrease in the stratospheric halogen load and a slowing of ozone decline is expected to be the natural precursor of a complete ozone recovery around the mid-century. There is presently experimental evidence that the global mean ozone total column is no longer decreasing with respect to the 1998-2001 period. Also, the ozone stratospheric distribution has been relatively constant during the last decade although both dynamical and chemical processes may contribute to decadal changes in the lower stratosphere. On the other hand, column ozone loss in the 2010/2011 Arctic winter was among the largest ever observed whereas Antarctic ozone depletion has probably stabilized during the last decade.

Clearly, the monitoring of ozone stratospheric abundances is of crucial importance in assessing the milestones of a clear recovery process.

Among important trace gases, methane is very important for its impact on climate through a large radiative forcing effect and the production of stratospheric water vapor. A global increase of about 0.7 ppm in 1800 AD to 1.8 ppm nowadays is difficult to interpret because of the diversity of the sources: wetlands, enteric fermentation, fires and rice agriculture.

Similarly, the NO_x family is known to play an essential catalytic role in ozone destruction with a strong diurnal cycle that requires day- and nighttime measurements for a full characterization. On the other hand, these species may be converted into inactive forms or reservoirs. In particular, the NO_2 reacts with ClO to form ClONO₂ and the measurement of OCIO (depending itself from the presence of ClO and BrO) and BrO (daytime) in the UV is very important if it can be anti-correlated with NO_2 simultaneous observations.

It is highly desirable to combine the advantages of nadir-viewing and limb-viewing techniques. What is ideally needed is an instrument with a vertical sampling similar to that of an occultation instrument but with coverage similar to that of a backscatter instrument. This is the framework of the ALTIUS mission (Atmospheric Limb Tracker for the Investigation of the Upcoming Stratosphere) as proposed by the Belgian Institute for Space Aeronomy: a Belgian spaceborne instrument for the remote sensing of ozone and other important trace gases. ALTIUS will make use of the limb scattering technique but its imaging capacity will allow for solving the issues of altitude registration, cloud identification and horizontal gradients of measured species.

The Atmospheric Limb Tracker for the Investigation of the upcoming Stratosphere mission (ALTIUS) mission will be dedicated to the measurement of the vertical distribution of key atmospheric trace gases. The primary target is ozone, but secondary objectives are NO_2 , methane, water vapor, aerosols, BrO, etc... The sounding altitude range will be mainly from clouds top up to 100 km, i.e. from the troposphere to the mesosphere. It will be placed on a sun-synchronous polar orbit 650 km above the ground, ensuring a constant Sun-Earth-spacecraft angle corresponding to a 10h30 AM local time. One orbit will last for 100 minutes and the global coverage of the Earth will be reached after three days. The mission lifetime will be at least three years, targeting five.

The most innovative concept of ALTIUS is its capacity to perform multimode observations: limb scattering, solar and stellar occultations, etc.

ALTIUS will be embarked on a PROBA platform, a microsatellite class developed for ESA by QinetiQ Space in Antwerp (Belgium), which has demonstrated its capabilities with already two successful missions (PROBA-1 in 2001 and PROBA-2 in 2009). This microsatellite (about 1 m³ and 150 kg) shows excellent performances in terms of pointing stability (10 arcsec over 10 sec thanks to its miniaturized reaction wheels), attitude knowledge (1 arcsec using two star trackers), agility (rotation of 1°/sec/axis) and computing power.

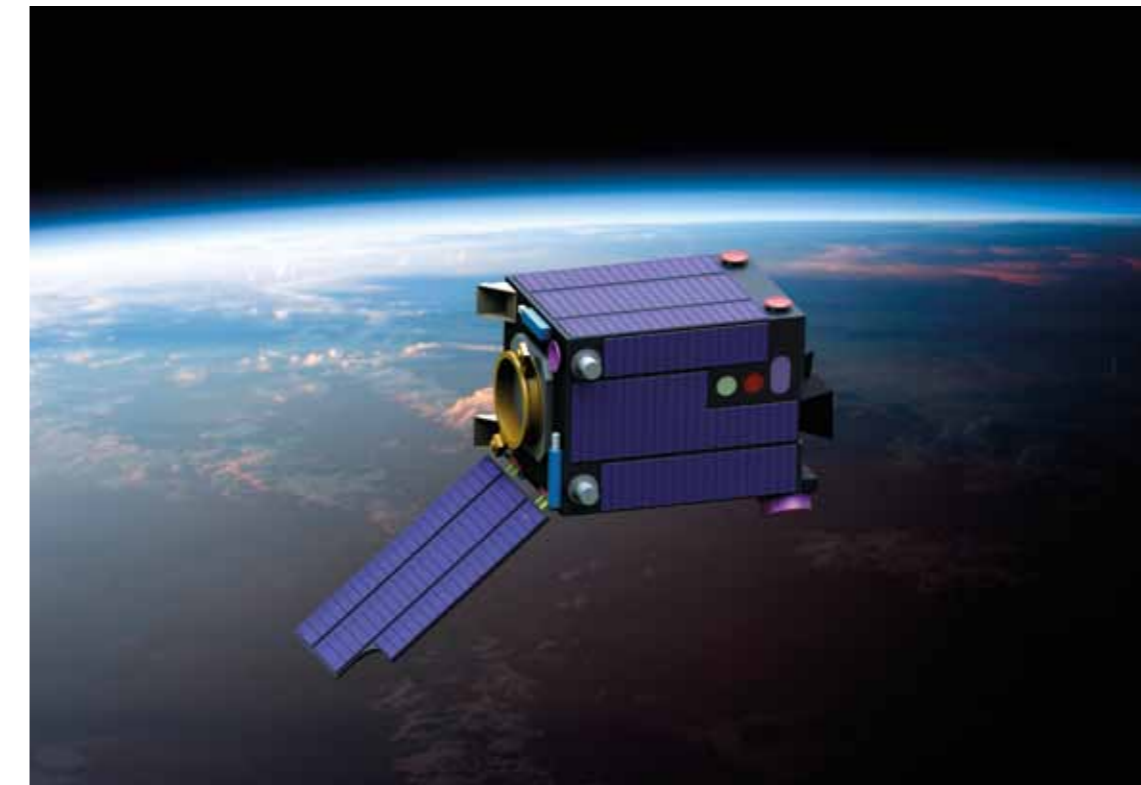

Artist view of ALTIUS on board of the PROBA platform, while leaving the night side.

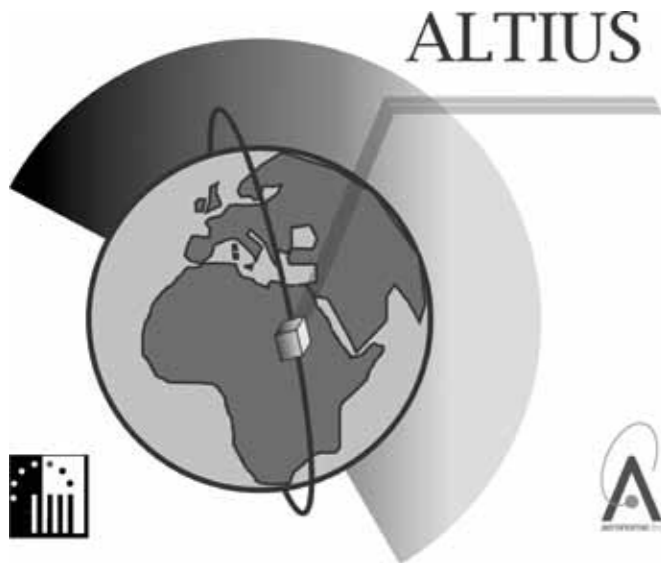

Logo of ALTIUS, a Belgian space experiment for atmospheric sounding.

The instrumental concept of ALTIUS has been driven by the mission requirements and the platform accommodation constraints. It consists of three independent channels, each of them operating in a specific spectral interval: 250 to 450 nm (UV), 450 to 900 nm (visible) and 900 to 1800 nm (near-infrared). Each channel contains a set of mirrors responsible for directing the incoming light into the AOTF (Acousto-Optical Tunable Filter), then relaying the selected spectral content to the detector. The three channels are almost identical with only minor differences. In the UV, the star magnitude is so faint that a telescope with a dedicated aperture had to be foreseen next to the bright limb aperture, whereas in the two other channels, the three observation geometries use the same entrance hole. In the near-infrared, the detector will be cooled by a rotating Stirling cooler in order to reduce thermal noise. The optical design and most of the technical studies were performed by "Optique et Instruments de Précision" (OIP) in Oudenaarde.

Summary

ALTIUS is a limb sounder spectrometer, capable of a 1 km vertical resolution. It consists of one or several spectral camera's (optics+AOTF+2-D imager) in the UV-visible-Near IR range. The instrument, on board a heliosynchronous microsatellite, can be operated in different viewing modes (limb, solar occultation, stellar occultation) and/or scenarios by the scientific user. It is optimized for on board signal processing (including image compression). The main geophysical targets are stratospheric/mesospheric profiles of ozone and some minor trace gases (NO₂, H₂O, BrO, aerosols,...). The retrieval of these quantities requires a considerable inversion algorithm and associated computing power.

ALTIUS will be the first Belgian atmospheric mission for the sounding of the upper atmosphere. Being a fully integrated mission, it represents an exciting challenge for BIRA-IASB. The main objectives are to provide stratospheric measurements to monitor global changes and to meet the need for (in particular, European) instruments capable vertical remote sounding of the atmosphere. With the development of ALTIUS, new and promising technologies are emerging. The goal is to reach as many potential communities as possible to use the data and to promote the ALTIUS concepts, from a scientific level to an operational capacity.

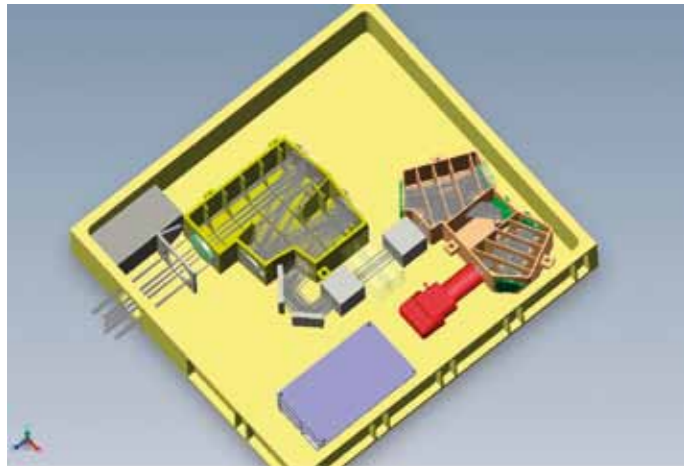

Preliminary optical layout of the spectral imager in the visible domain. The mechanism after the entrance hole has been fully designed by BIRA-IASB.

THE PICOSATELLITE FOR ATMOSPHERIC AND SPACE SCIENCE OBSERVATIONS MISSION: TOWARD GEOPHYSICAL MEASUREMENTS FROM MINIATURIZED SPACE SENSORS

Didier Fussen, Didier Peroux Sylvain Ranvier and Johan De Keyser
With contributions from Pepijn Cardoen, Jurgen Vanhamel, Emmanuel Dekemper, Hervé Lamy, Özgür Karatekin (ORB-KSB), Ping Zhu (ORB-KSB) and Véronique Dehant (ORB-KSB)

The QB50 flight opportunity

The objective of the QB50 project is to deploy 50 CubeSats built by university teams and research institutes originating from all over the world to explore the lower thermosphere and to study the atmospheric re-entry process. The main launch is foreseen at the end of 2015.

QB50 is driven by an international consortium under the leadership of the von Karman Institute (Sint-Genesius-Rode, Belgium). It has been granted the financial support of the 7th European Commission Framework Programme (FP7).

PICosatellite for Atmospheric and Space Science Observations (PICASSO) is a joint project led by the Belgian Institute for Space Aeronomy (BIRA-IASB) in collaboration with the Royal Observatory of Belgium. A triple-unit CubeSat targeting the precursor flight will be developed to embark two scientific experiments dedicated to the study of the ozone distribution in the stratosphere, the temperature profile up to the mesosphere, and the electron density and temperature in the ionosphere.

For the sake of illustration, the figures hereby display one of the possible configurations for PICASSO. The CubeSat is equipped with four deployable solar panels always facing the Sun. Extra body-mounted panels ensure the powering of the spacecraft in case of off-nominal orientation. The payload is located in the cube facing the Sun.

In summary, to achieve the objective of being a demonstrator of the use of picosatellites for scientific applications, PICASSO will embark two experiments:

- **VISION**, a visible and near-infrared hyper-spectral imager;
- **SLP**, a Sweeping Langmuir Probe;

The VISION aperture is clearly visible on the Sun-illuminated face. A Langmuir probe is found at the extremity of each panel.

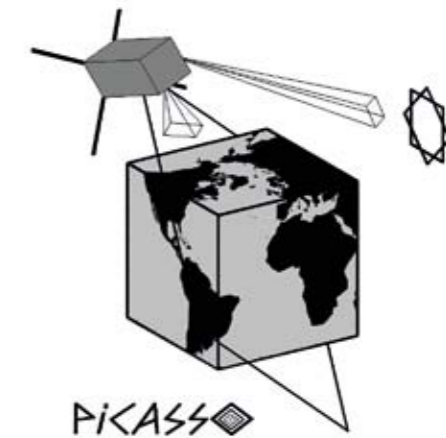

The PICASSO CubeSat mission logo with a reference to one of the fathers of the cubism art style.

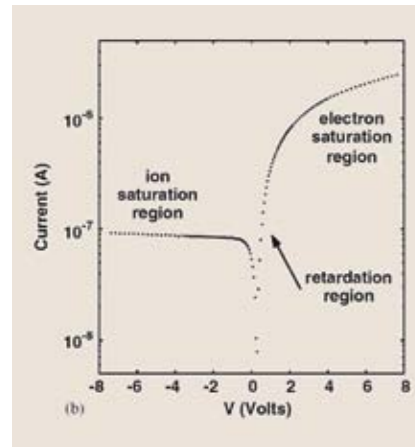
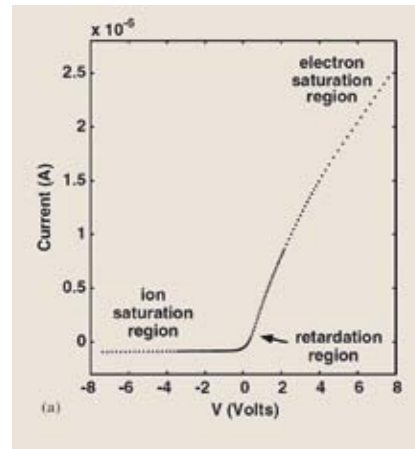

The SLP instrument will accurately measure the current-voltage characteristics by sweeping the probe potential.

The Visible Spectral Imager for Occultation and Nightglow (VISION) is a tuneable spectral imager active in the visible and near-infrared. It targets primarily the observation of the Earth's atmospheric limb during orbital Sun occultation. By assessing the radiation absorption in the Chappuis band for different tangent altitudes, the ozone concentration vertical profile can be retrieved. A secondary objective is to measure the deformation of the solar disk so that stratospheric and mesospheric temperature profiles are retrieved by inversion of the refractive ray-tracing problem. Finally, occasional full spectral observations of polar auroras are also foreseen.

In the atmosphere, solar light is refracted and it bends towards the Earth. From the imager perspective, refraction leads to two phenomena. Firstly the Sun's apparent position is displaced away from the Earth, as if the Earth was repelling it. Secondly, as illustrated in the figure, the apparent shape of the solar disk shrinks along the vertical dimension (relative to the Earth image). This deformation comes from the fact that rays emanating from the bottom of the Sun image propagate into denser atmospheric layers than those emanating from top. By solving the inverse ray-tracing problem of the photon propagation in the atmosphere, mesospheric and stratospheric temperature profiles can be retrieved.

PICASSO will also operate a *Sweeping Langmuir Probe* (SLP) instrument for electronic densities and temperature measurements in the upper atmosphere with a particular interest for the polar regions. BIRA-IASB plans to carry out coordinated ground-based observations with the European Incoherent Scatter (EISCAT) radar experiment located in Tromsø (Norway), as this could strongly enhance the scientific output of the mission.

At 500 km altitude, PICASSO is flying through the upper layers of the ionosphere with an orbital period of 94 minutes. Given its high inclination, PICASSO will sample the ionosphere at this altitude rather globally. It is therefore obvious to use PICASSO as a platform for a global monitoring of the ionosphere. To that end, SLP is an ideal instrument as it can measure the amount of ionized particles and the temperature of electrons. The SLP instrument is an upgraded version of the traditional Langmuir probe. It includes four cylindrical probes whose electrical potential is swept in such a way that both electron temperature and density can be derived together with the spacecraft potential with respect to the plasma potential. In addition, since at least two probes will be out of the spacecraft's wake, differential measurements will be performed in order to increase the accuracy of the derived parameters.

Ozone Concentration

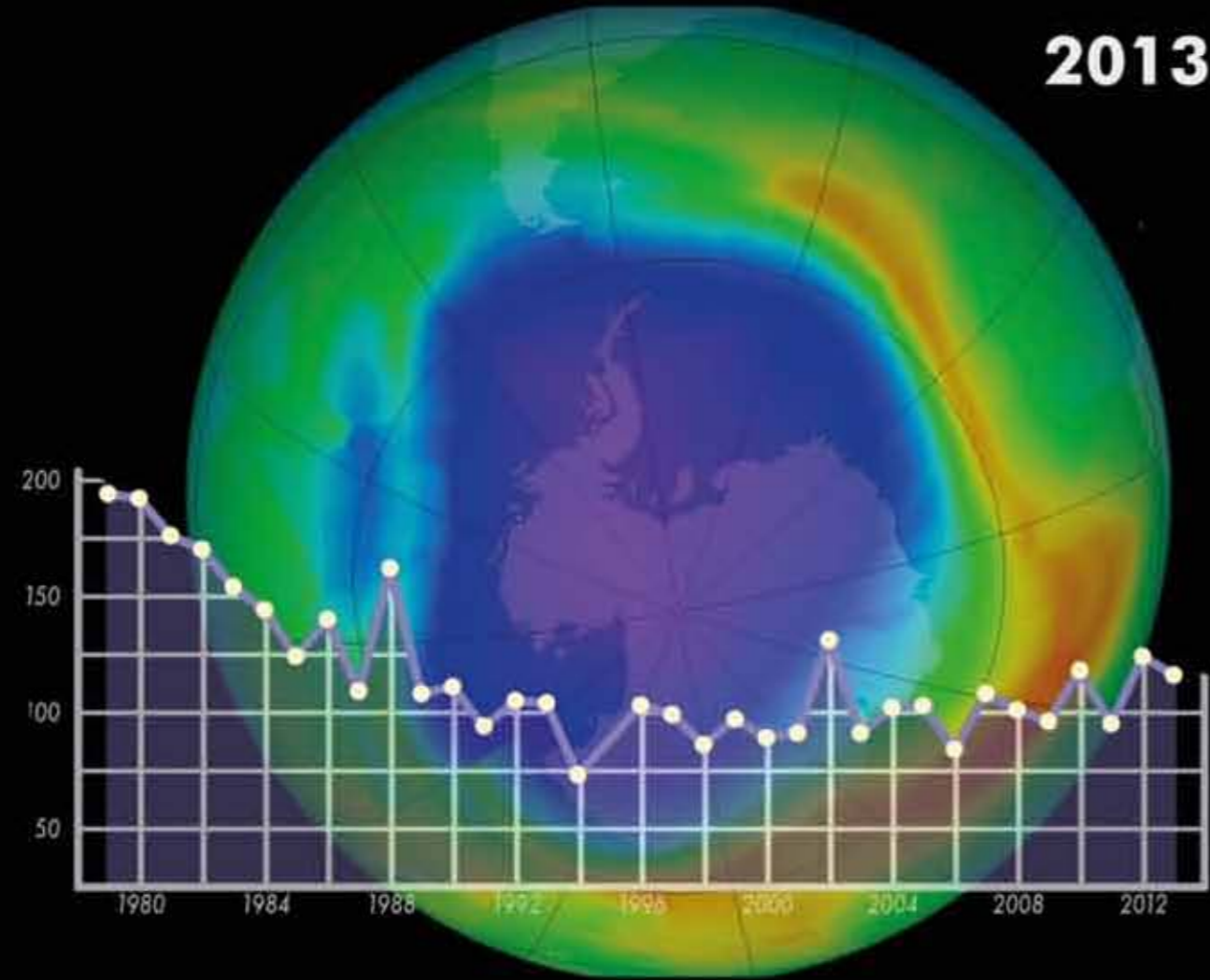

BELEGCH INSTITUUT VOOR RUIMTE-AERONOMIE (BIRA) INSTITUUT D'AERONOMIE SPATIALE DE BELGIQUE (IASB) BELGIAN INSTITUTE FOR SPACE AERONOMY (BIRA-IASB) BELGIECH INSTITUUT VOOR RUIMTE-AERONOMIE (BIRA) INSTITUUT D'AERONOMIE SPATIALE DE BELGIQUE (IASB)

THE ENDANGERED OZONE LAYER

Paul C. Simon

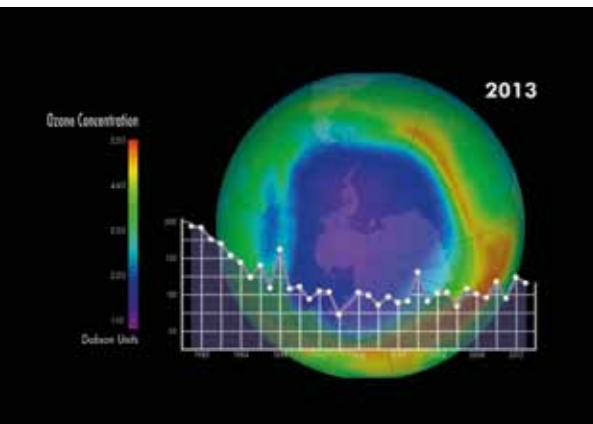

The ozone hole history showing the evolution of the ozone concentration minima since 1979. The background image represents the ozone hole in 2013. (credit: NASA)

Total ozone column

The total ozone column content is defined as the vertical integral of the ozone concentration from the surface to space. 300 Dobson Units (DU) = 3 mm of pure O₃ at a standard pressure and temperature of, respectively, 1013 hPa and 273 K. (from J. London, 1980)

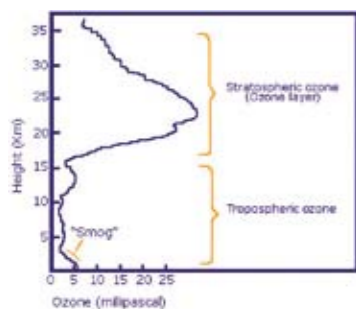

Vertical distribution of ozone (expressed in millipascal, the partial pressure) from the surface to the stratosphere.

Guy Brasseur (MPI-M, NCAR) and Paul C. Simon

Ozone, which protects the biosphere from harmful solar ultraviolet radiation and plays a key role in the radiative budget of the middle atmosphere, is present in the atmosphere from the surface to as high as 100 km altitude. The peak density of this chemical constituent is located near 25 km altitude in the tropics and 18 km at high latitude. The transmission of solar radiation in the 200-310 nm wavelength range is determined by the ozone column density, which corresponds, for standard pressure and temperature conditions, to a highly absorbing layer with a thickness of only 2.5 to 4.5 mm (250 to 450 Dobson Unit).

Ozone is produced by the action of solar ultraviolet radiation on molecular oxygen at wavelengths shorter than 242 nm. Its destruction by recombination with atomic oxygen is catalysed by the presence of different radicals belonging to the families of hydrogen (H, OH, and HO₂), nitrogen (NO, NO₂), chlorine (Cl, ClO), bromine (Br, BrO), etc. . . The relative contribution of these radicals to the ozone loss varies with altitude: in the mesosphere (50-85 km), the most efficient processes are due to the hydroxyl (OH) radicals while in the stratosphere (15-50 km), the most important destruction agents for ozone are the nitrogen oxides. The effects of chlorine are the largest near 40 km altitude (under conditions prevailing outside the polar regions). In the second half of the eighties, measurements have shown that the chlorine chemistry is substantially modified in the cold stratosphere over Antarctica in Spring.

Climatology of Ozone

Observations of ozone reveal that the mean total ozone content increases with latitude with the most pronounced latitudinal gradient in late winter and early Spring. The spatial distribution is significantly different in the two hemispheres. Ozone, which is produced essentially in the upper stratosphere at mid- and low latitudes,

is transported downwards and towards higher latitudes by the stratospheric meridional circulation, which is particularly strong during winter when planetary waves (which are produced by the wind flow over large mountain ranges) propagate and dissipate in the stratosphere. Ozone therefore accumulates at high latitudes during winter and the total column density reaches a maximum value in early spring. Because of hemispheric differences in orography, the strength of the planetary waves is weaker in the Southern than in the Northern hemisphere and the meridional flux of ozone and heat significantly lower in the austral than in the boreal regions. The presence of a strong and undisturbed polar vortex over Antarctica in winter explains the low ozone content and the relatively cold temperature (about 10 K lower than in the Arctic region) at the South Pole as well as the presence of a warm zonal belt near 60 degrees South with high ozone content. This morphology is important for explaining the observed ozone hole over Antarctica and shows how dynamics produce the conditions allowing for rapid chemical ozone destruction in this region.

The temporal and geographical variations of ozone are also influenced by meteorological conditions near the tropopause and by oscillations in wind and temperature in the stratosphere. Variations in the solar ultraviolet radiation associated with the 27-day rotation period of the Sun and its 11-year cycle affect also ozone concentrations above 30 km altitude (see chapter 3).

Total Ozone Content Monitoring and Trends

Monitoring of the total ozone column has been performed in Arosa (Switzerland) since 1926 by means of a Dobson spectrophotometer but one has to wait until 1957-1958, during the IGY, to see the worldwide ground-based Dobson network to be deployed. The determination of a long-term trend from these observations is difficult to achieve because of the poor geographical coverage of the ground-based instruments. For instance, observations are predominantly concentrated in the mid-latitudes of the Northern hemisphere leading to oversampling with respect to the equatorial zone and the Southern hemisphere. An analysis of the Dobson data shows that, after the effects of the dynamical oscillations and the solar cycle are removed, the residual (negative) trend in total ozone for the 1970-1986 time period is of the order of 2-3 percent at mid- and high latitudes in the Northern hemisphere.

Monitoring from space provides very good latitude coverage. Systematic monitoring started in the 1970s with the BUUV instrument on board the Nimbus 4 satellite. Nimbus 7, with the Solar Backscatter Ultraviolet (SBUV) spectrometer and the Total Ozone Mapping Spectrometer (TOMS) provided continuous data from the end of

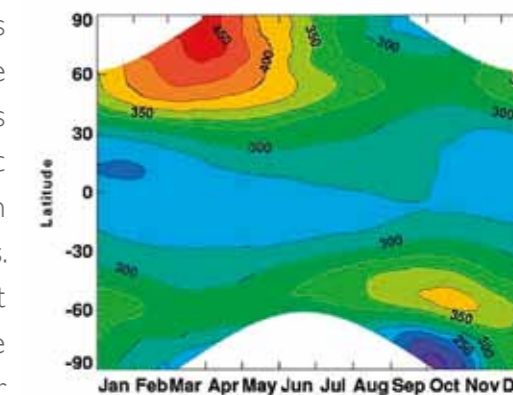

Total ozone climatology as function of latitude and months derived from TOMS observation from 1979 to 1992. (credit NASA)

Polar vortex

Dynamical structure of the stratosphere in polar winter caused by the absence of solar illumination which leads to a cooling over the poles. The air within the vortex is relatively isolated in comparison with surroundings regions. From S. Solomon

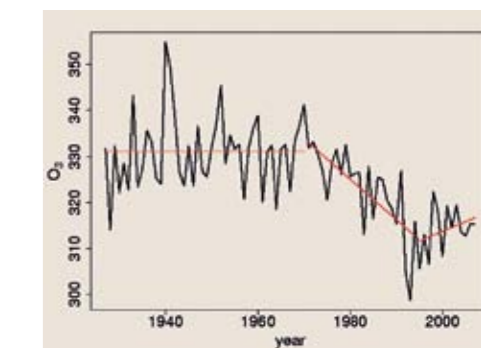

Time series of total ozone column (in Dobson units) obtained in Arosa (Switzerland) since 1926 with a Dobson instrument. The ozone depletion starting around 1970 is clearly observed.

Ozone Trend Panel

Different agencies participated to this initiative: the Federal Aviation Administration (FAA), the National Oceanic and atmospheric Administration (NOAA), the World Meteorological Organisation (WMO) and the United Nations Environmental Program (UNEP). The panel membership was composed by more than 100 scientists. (Report of the international ozone trend panel, WMO Report 18, Geneva, 1998. This report is also published in the NASA Reference Publication 1208, "Watson R.T. and Ozone Trends Panel, M. J. Prather and Ad Hoc Theory Panel, and M. J. Kurylo and NASA Panel for Data Evaluation (1988), Present State of Knowledge of the Upper Atmosphere 1988: An Assessment Report, National Aeronautics and Space Administration, Scientific and Technical Information Division, Washington D.C."

CFC

Chlorofluorocarbons (CFCs) and halons (organic compound containing mostly bromine atoms), along with carbon tetrachloride (CCl_4) and methyl chloroform (CH_3CCl_3) are the primary man-made ozone depleting chemicals. The substitutes for CFCs, the hydrochlorofluorocarbons (HCFCs), have lower ozone depleting potential. Chlorofluorocarbons have had many uses, e.g. in refrigerators and air conditioners and as industrial solvents. Halons are used as fire extinguishers. They will remain a threat to ozone in the stratosphere for decades until the middle of the 21st century.

1978 till 1994. The retrieved quantitative values were, however, subject to controversy because of instrument degradation in orbit, leading to large uncertainties in the observations. This issue was tackled in 1986 by the "Ozone Trend Panel", coordinated by NASA. The final report was published in 1988.

Europe started ozone monitoring from space in 1995 with the Global Ozone Monitoring Experiment (GOME), followed by ENVISAT, OMI and GOME-2 (see chapter 8).

To ensure long-term monitoring and trend quantification, there is a mandatory need for combined and coordinated measurements with complementary sensors on different platforms (ground-based, balloon and aircraft, and space-borne) to provide integrated datasets, complemented with models and assimilation tools to make predictions reliable. The observations must be processed into information accessible to a wide range of users including the scientific community, the environmental organisation, the policy-makers, and to verify the effectiveness of treaties.

The issues encountered with satellite observations initiated the concept of the Network for the detection of Stratospheric Change (NDSC, renamed NDACC in 2006) and, more recently the definition of the Integrated Global Observing Strategy (IGOS).

Considerable effort has been dedicated to instrument intercomparison campaigns and to satellite validation activities in order to improve the consistency among the various measurements. More and more sophisticated instruments and techniques for ground-, space-based and/or for in situ use have been developed and together with the advances in numerical compilation facilities, have broadened the potential to study, monitor and model atmospheric variables on a global scale. Today the networks not only support research related to the Earth's System and its expected evolution, but also allow scientific assessments on global change, e.g. the UNEP/WMO Scientific Assessment of Ozone Depletion and the IPCC Assessment Report on Climate Change, and subsequent summaries and guidance for international policymaking.

Increases in the atmospheric concentration of methane, nitrous oxide and the chlorofluorocarbons (CFCs) are modifying the density of the active radicals affecting the ozone budget inducing worldwide negative trends in ozone concentration.

The protection of the ozone layer is a major concern since this layer shields the biosphere against harmful

UV-B (290- 315 nm) and UV-C (200-290 nm) radiation. Abiotic ultraviolet radiation is strongly absorbed by the DNA molecules of living cells and alters reproductive processes of these cells. A well-known example is the relation between UV-B exposure and human skin cancer although other biological effects could lead to even more important consequences. The global warming at the Earth's surface expected from increasing levels of chemical compounds in the atmosphere could produce major climatic changes with substantial environmental consequences.

Since the end of the sixties and during the seventies, several threats to the ozone layer due to anthropogenic activities have been addressed by extensive scientific researches and international programmes in which BIRA-IASB has been deeply involved.

THE SUPERSONIC AIRCRAFT THREAT TO THE OZONE LAYER

Christian Muller

In the beginning of the seventies, the greatest concern was the potential destruction of stratospheric ozone by direct supersonic aircraft emissions in the stratosphere.

The airline industry planned on a very large increase in the demand for passenger transport, which could be done in two ways: one was to increase the size of planes, the second was to increase speed and thus to have a faster turnover of the fleet. The second option seemed economically possible for the business travel market and led to a projection of 150 medium-sized aircrafts and 350 large-sized and long-range planes.

Developments were under way for a realistic medium-sized airplane in France and UK - the Concorde, a four engine transatlantic carrier of around 100 passengers flying at 16 km-, while the Russian and American projects were carrying more than 200 passengers at an altitude of 24 km. Concorde was based on a flight profile and hardware routinely tested by supersonic bombers of that time. On the contrary, the American and Russian concepts had only been tested by prototypes and their higher speed excluded aluminium. Therefore, Concorde was the first to fly in 1969. The Russian prototype of the TU-144 flew later but never proved that it could carry more than its own fuel and was never operated in a scheduled line; the American prototype



Take-off of a Concorde during a commercial flight, the exhaust clearly shows a red trail due to the instantaneous transformation of nitrogen monoxide to nitrogen dioxide on the surface. This high production of nitrogen oxides reflects the very high efficiency of the Concorde engines. (credit: Philippe Noret)

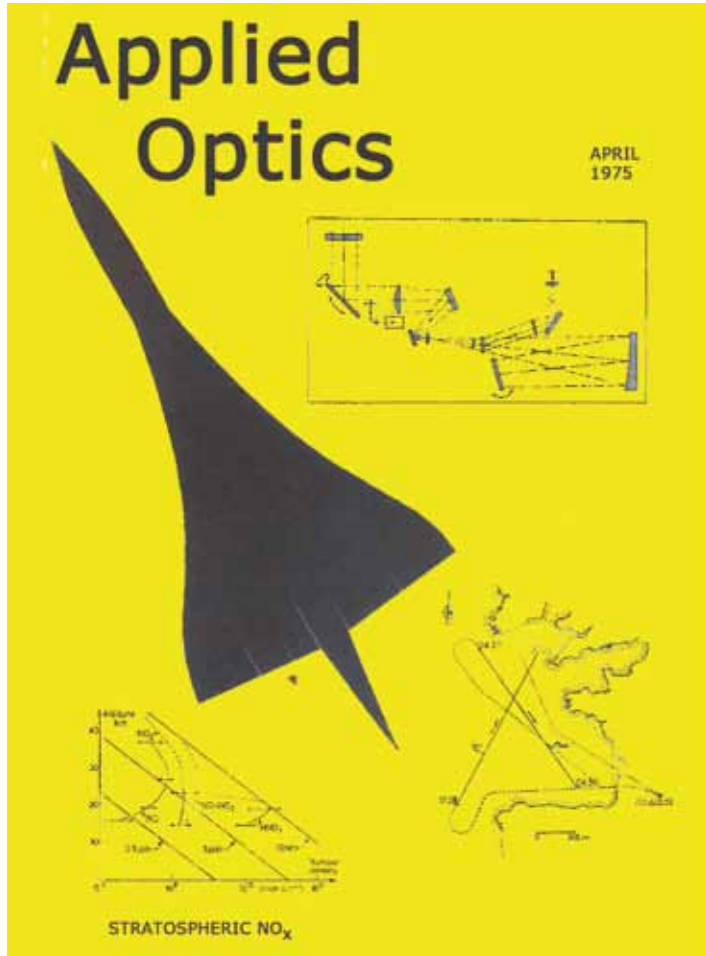

Applied Optics cover in April 1975 referring to the Concorde flight with the infrared Grille spectrometer and reporting nitrogen oxide concentration in the stratosphere.

did not reach completion due to a political campaign criticizing the high cost of subsidizing a prestige project. Environmental considerations were also a minor part of this campaign. The first concern was that the emission of soot by the supersonic transport (SST) engines would lead to a permanent layer in the stratosphere and thus would trigger global cooling of the troposphere and precipitate a new ice age. A second argument appeared almost at the same time of the Concorde first flight and US SST dismissal, when Harold Johnston, professor of chemistry at Berkeley University indicated in 1971 that nitrogen oxides produced in the high-temperature supersonic aircraft exhaust could contribute significantly to ozone loss by releasing the nitrogen oxides directly into the stratospheric ozone layer. The first model simulations suggested that a fleet of 500 Concorde could contribute up to 15% ozone loss in the 16-18 km altitude range.

The nitrogen oxides catalytic chain leading to ozone destruction was an instant success among activist students and the main point of an intense anti-Concorde lobby. At that time, a lot of exaggerations circulated, the unfiltered UV leading to apocalyptic consequences from the blinding of all animals to the disappearance of surface life. The direction of the "Aérospatiale", the French Concorde manufacturers, did not believe that this campaign was based on scientific arguments and discretely asked members of BIRA-IASB around Marcel Nicolet to conduct an independent assessment, based on stratospheric balloon observations of the Aeronomy institute which already proved that nitrogen dioxide was present in the Earth's stratosphere. The problem was thus posed in a different way: "How many Concorde may fly without having a significant consequence on the biosphere?"

For the aerospace industry, the chemistry and dynamics of the stratosphere were a non-negligible concern related to the air distributed by the compressors to the passengers and could lead to optimal flight plans if the equivalent of the upper tropospheric jet streams could be found at higher altitude. The convergence of these approaches led to research contracts between industry and the Institute.

The French "Aérospatiale" money and especially the use of the "Aérospatiale" computers led the Institute to a rapid advance on the quantification of nitrogen dioxide. The modelling effort, in particular related to the identification of nitric acid as the end of the catalytical chain, successfully increased.

After Johnston's statement, the priority was the measurement of nitrogen oxides concentrations in the stratosphere on board Concorde prototype 001 and by means of balloon-borne instruments. That was the beginning of the fruitful collaboration between the "Office National d'Études et de Recherches Aérospatiales" (ONERA) with André Girard and Nicole Louisnard, and BIRA-IASB with Marcel Ackerman and his co-workers. The infrared Grille spectrometer designed by André Girard was adapted for atmospheric observations and,

on its first flight on the Concorde prototype, it discovered nitric oxide which was confirmed by the first balloon flight of the same instrument. (See chapter 6).

In parallel, the French and British governments decided to create a temporary structure, the Comité d'Études sur les Conséquences des Vols Stratosphérique (COVOS)/Committee on the Meteorological Effects of Stratospheric Aircraft (COMESA) chaired in France by Edmond Brun. In order to study the problem and fund research, a similar effort was initiated by the US department of transportation, the Climatic Impact Assessment Programme (CIAP) and the scientific research of BIRA-IASB was then integrated in a much larger frame. At the end of these programmes in 1976, new model simulations with updated kinetic coefficients of key gas phase reactions measured in the laboratory, showed that the threat was not significant, of the order of 1% only. Their conclusions were followed by a tri-national agreement allowing Concorde to fly on an experimental basis. Only twenty Concorde aircraft were ever built (of which six for development and fourteen for commercial service), but none of the predicted catastrophic consequences were verified. Finally, in 2003, Concorde was definitively retired due to changing economics and renewed safety concerns after its crash during take-off on 25 July 2000.

THE HALOCARBON THREAT AND POLAR OZONE

Paul C. Simon

In 1974, Ralf Cicerone and Richard Stolarsky suggested that chlorine could catalytically destroy ozone in the stratosphere. The role of the man-made halocarbons, as chlorine source in the stratosphere, was identified the same year by Mario Molina and Sherwood Rowland (the future winners of the Nobel Prize for Chemistry with Paul Crutzen in 1995). These very stable and consequently long-lived organic compounds produced at the Earth's surface spread throughout the whole troposphere and are transported by atmospheric dynamics to higher altitude. Active chlorine and bromine in the stratosphere results from the photodissociation of the CFCs and halons by solar UV radiation of wavelength around 200 nm in the upper stratosphere. Changes in the ozone density due to the increase of ozone-depleting substances also modify the altitude of penetration of solar ultraviolet radiation and the related stratospheric heating rate.

Concerns about these threats led to a limited political response. In 1978 the United States, Canada, Belgium, Norway and Sweden banned the use of CFCs as propellants in aerosol cans. The countries of the European Community adopted measures to reduce CFC use in aerosols by 30% from 1976 levels, and agreed not to increase their CFC production capacity. Australia reduced CFC use in aerosols by 66%. Some of these

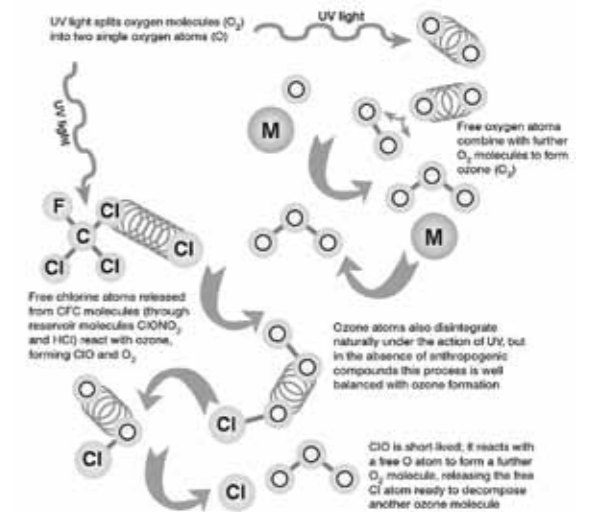

The destruction of ozone molecules by chlorine compounds in the atmosphere. (Credit: Ozone Secretariat (2000) Action on Ozone, UNEP, Nairobi)

products led to a ban on the use of CFCs as aerosol propellants in several countries. However, production of CFCs and other ozone-depleting substances grew rapidly afterward as new uses were discovered.

Antarctic Ozone

In 1985, Joe Farman, Brian Gardiner and Jon Shanklin, scientists at the British Antarctic Survey, reported that the ozone column measured in October over the scientific station of Halley Bay (76°S, 27°W) had gradually decreased by about 40 percent between 1979 to 1984. These results were based on ground-based observations obtained by means of a Dobson spectrophotometer. Joe Farman and co-workers suggested that this trend could have been produced by chlorine compounds of anthropogenic origin. Subsequently, satellite data available since 1979 but not analysed because of unexpectedly low values of total ozone densities, were reconsidered successfully. They showed that the ozone hole is formed in early September and lasts until November, and that it extends over essentially the entire Antarctic continent. Finally, the satellite measurements showed that the decrease in ozone is not entirely confined in the polar vortex but extends to latitudes near 45°S but with smaller amplitudes. Subsequent data analysis suggested that since 1979, Antarctic ozone has noticeably been perturbed all year round.

A first campaign was organized by the United States to perform coordinated measurements at the US station of McMurdo in Spring 1986. This campaign confirmed the recurrence of the “ozone hole”. David Hofmann and co-workers showed in 1986 that the altitude of the ozone depletion was ranging from 12 to 22 km. Unusual chlorine and nitrogen concentrations were revealed by comparison with mid-latitude conditions. For example, observations showed very low abundances in NO₂ and large amounts of ClO in the lower stratosphere, near 20 km. For the first time, OClO molecules were detected, confirming the importance of chlorine chemistry in the polar vortex. A second campaign, taking place in August and September 1987, confirmed these findings (for more information, see the review paper of Susan Solomon, 1988).

An important feature is the more frequent occurrence of stratospheric clouds in both polar regions during winter conditions, observed by the SAM II experiment on board Nimbus 7 satellite since late 1978, reported by Patrick McCormick and co-workers in 1982. The presence of these clouds is noticeable in June-September 1979 with similar signatures repeated each year. These Polar Stratospheric Clouds (PSCs) are the consequence of the very low temperature in the polar vortex.

The study of the ozone response to perturbations of natural and anthropogenic origin requires a detailed understanding of chemical, radiative and dynamical processes occurring simultaneously in the atmosphere. The most recent models account for the most important couplings between these processes. These models are the only tools presently available to predict the effects of perturbations in the future. They are used to

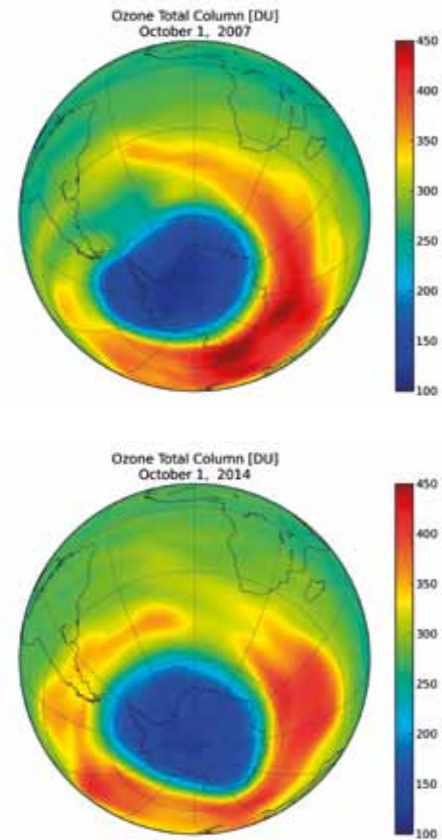

Maps of total ozone column in Dobson Unit, on 1st October 2007 and 26 September 2014, from BASCOE data assimilation model developed at BIRA-IASB (see chapter 14) and used in the MACC-II project (see end of chapter 9). Observations obtained from the Microwave Limb Sounder (MLS) on board AURA/NASA satellite.

identify the relative importance of different atmospheric processes and to validate theory against available observations.

Concerns on the ozone layer depletion first led to the Vienna Convention on the Protection of the Ozone Layer signed in 1985. This treaty was the precursor to the Montreal Protocol on Substances that Deplete the Ozone Layer adopted on September 16, 1987 for controlling the production and use of man-made chlorofluorocarbons and halons. It was amended four times in London (1990), Copenhagen (1992), Montreal (1997) and Beijing (1999). In addition to adjustments and amendments to the Montreal Protocol, the Parties to the Protocol meet annually and take a variety of decisions aimed at enabling effective implementation of this important treaty.

The European Scientific Response

The European Union (EU) and its member states had endorsed the Montreal Protocol on Substances that Deplete the Ozone layer. Therefore, the European Commission (EC) undertook stratospheric research activities in conjunction with research programmes of individual countries and in liaison with the World Meteorological Organisation (WMO) and the United Nations Environment Programme (UNEP). Ministers of the European Union and of the European Free Trade Association agreed in October 1987 to initiate the European coordination of such research activities. At a meeting in The Hague (The Netherlands) in 1988, they agreed on the setup of a small coordination group. Thanks to Heinrich Ott, head of the Environment Division of the General Direction XII, the EC “Science Panel on Stratospheric Ozone” was installed in 1989 under the chairmanship of Gérard Mégie (Service d’Aéronomie of the CNRS, France). At the same time, the European Ozone Research Coordinating Unit (EORCU) was also set up to manage, organise and coordinate these activities, headed by John Pyle (University of Cambridge, UK) and Neil Harris. Since the beginning, BIRA-IASB was participating to the discussion and scientists from the Institute were nominated as members of this panel.

After the discovery of the ozone hole over Antarctica, it was suggested that similar processes were taking place in the Arctic, leading to ozone losses. The deep ozone hole over Antarctica is the consequence of persistent low temperatures within a stable vortex, initiating Polar Stratospheric Clouds formation and heterogeneous chemistry. In the Arctic, the meteorological situation is different with an unstable vortex and less severe temperature. Nevertheless, Polar Stratospheric Clouds can occasionally be formed, allowing the chlorine activation in the Arctic stratosphere.

After having decided to study the processes leading to stratospheric ozone depletion in the northern hemisphere, the first task was the coordination of a large scale field campaign: the European Arctic Stratospheric Ozone Experiment (EASOE), which was composed of research projects under the EC Environment Programme. The

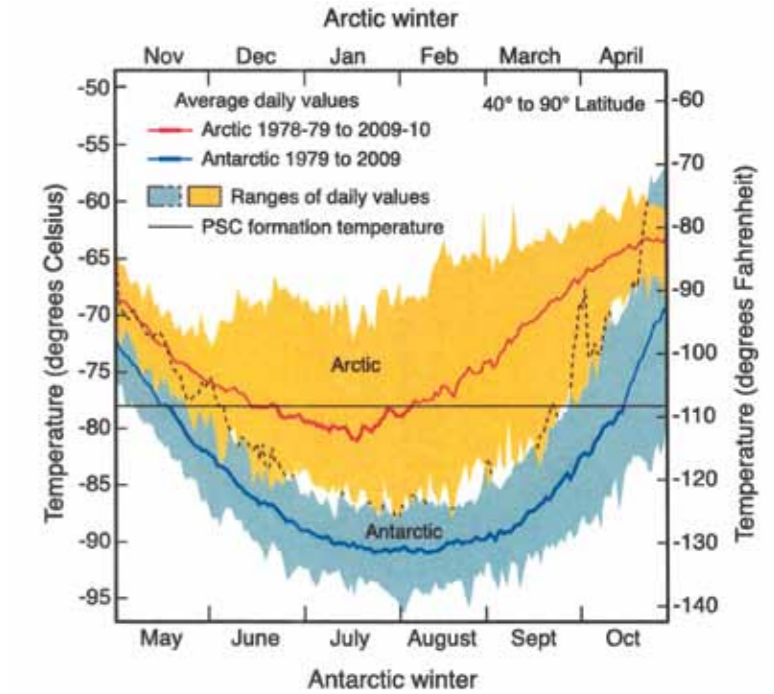

Minimum air temperatures in the Polar Stratosphere. Daily mean temperatures are shown for the Arctic (upper axis) and Antarctic (lower axis) winters, averaged over the period 1978-2009. (credit: UNEP/WMO)

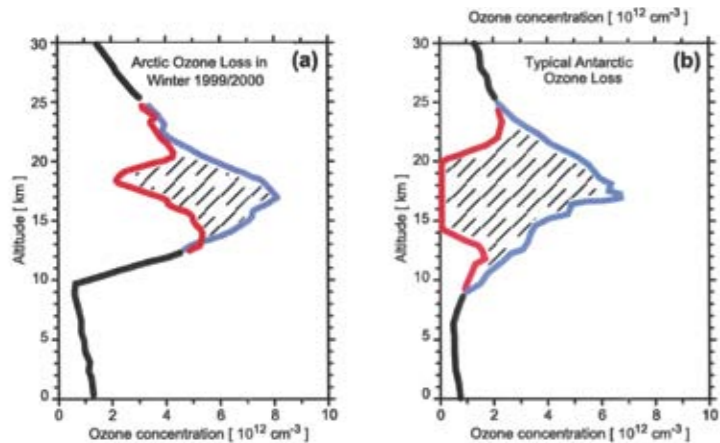

Arctic ozone depletion observed in the winter of 1999/2000 compared to a typical Antarctic ozone hole. (credit: UNEP/WMO)



Official launch of the THESEO 2000 - SOLVE campaign in Kiruna by the European Commissioner at the Direction General Research Philippe Busquin (credit European Commission).



SESAME logo

campaign aimed at understanding the causes of the observed ozone losses in the Northern Hemisphere. From November 1991 to March 1992, over 60 research groups (mainly from Europe, but including a few from the USA, the USSR, and Japan) performed experiments to investigate the Arctic stratosphere. A major collection of scientific papers from EASOE appeared in a special issue of *Geophysical Research Letters* in June 1994. BIRA-IASB was involved with ground-based measurement in the UV-visible range of NO_2 in Keflavik (Iceland) and at the Jungfraujoch station (Swiss Alps). The observations confirmed ozone depletion of the order of 20% during the cold winter period, much less than in Antarctica because of the higher stratospheric temperature by about 10 Kelvin in the Arctic and the earlier dissipation of the vortex in Spring.

The second major European campaign, the Second European Stratospheric Arctic and Mid-latitude Experiment (SESAME) was supported by 15 projects in the framework of the EC Environment Programme, along with some participation by non-EU states, and took place between January 1994 and December 1995 to cover a complete seasonal cycle. Direct field measurements consisted of balloon launches, scientific aircraft flights, ground-based remote sensing of atmospheric composition and some satellite measurements. In addition to the polar studies, SESAME examined the middle latitudes where long term ozone depletion has also been observed. In addition to ground-based observations, BIRA-IASB participated to a balloon campaign with the MACSIMS ion mass spectrometer. The scientific results of SESAME were published in special sections of the *Journal of Atmospheric Chemistry* in 1998 and 1999. The ozone depletion was more severe, reaching 30% of the ozone column abundance and even 50% at particular altitudes, because of the coldest stratospheric temperatures reported so far during that winter: "For the first time, Europe had a unique and proven capability to diagnose and monitor future ozone loss in the Arctic vortex, despite the atmospheric variability that makes this intrinsically more difficult in the northern hemisphere" (from the EC review "European research in the stratosphere", 1997).

The Third European Stratospheric Experiment on Ozone (THESEO) proceeded from winter 1997/98 to December 2000. The principal aim of THESEO was to improve our understanding of processes controlling the ozone loss over populated areas. Accordingly, the research was focussed on the mid-latitude lower stratosphere, the linkage to the other layers of the atmosphere, the Arctic vortex, the tropics and the subtropics. THESEO was funded by EC within the Environment and Climate Programme implemented under the Fourth Framework Programme, and by national science programmes. One EC project, the Third European stratospheric experiment on Stratospheric Ozone Destruction by Bromine (STRATOSPHERIC BrO) was coordinated by Michel Van Roozendael from BIRA-IASB.

During Winter/Spring 1999-2000, THESEO was joined by the NASA campaign SAGE III Ozone Loss and Validation Experiment (SOLVE). Measurements were made using the NASA DC-8 and ER-2 aircraft, as well

as balloon platforms and ground-based instruments. In addition to measurements from GOME on ERS-2 (ESA) and the Polar Ozone and Aerosol Measurements (POAM III) on CNES SPOT-4, those of TOMS on Earth Probe, HALOE and MLS on UARS and SAGE II on ERBS were included in the campaign. European cooperation in UV-B research also significantly increased during THESEO.

The fourth campaign, the Validation of International Satellites and study of Ozone Loss (VINTERSOL) took place from late 2002 until mid-2004. It was the latest of the major European field campaigns to study ozone loss and was funded jointly from national funding agencies and the Energy, Environment and Sustainable Development programme of the EC Directorate-General for Research. VINTERSOL examined the chemical and physical processes associated with stratospheric ozone depletion at Arctic and neighbouring mid-latitudes. The purpose of this campaign was also to validate satellite instruments such as GOME on ERS-2, ODIN and ENVISAT. These activities involved a variety of ground-based, balloon-borne, and aircraft-borne instruments coupled with comprehensive modelling activities. BIRA-IASB participated in two projects: QUILT (Michel Van Roozendael), and UFTIR (Martine De Mazière, coordinator).

The Quantification and Interpretation of Long-Term UV-visible Observations of the Stratosphere (QUILT) was a three-year EU project (2000-2003) devoted to the improvement and development of GOME data products, UV-visible ground-based and balloon-borne data, optimisation of the 3D Chemistry Transport Model and Radiative Transfer Model, as well as internet-based near real-time data dissemination. QUILT aimed to improve our understanding of global concentrations and trends of stratospheric ozone and related trace gas species (NO_2 , BrO, OClO, IO). The entire data record of the global NDSC UV-visible network and balloon-borne measurements has been reanalysed with the purpose of determining ozone loss in the past, monitoring its development in the present and investigating its relation to active halogen and nitrogen species. During the 2000/2001 winter, near real-time GOME measurements were produced. The project did, however, not start until early 2001 and hence, real-time information from the ground-based network was not available for the first winter of the campaign. It was, however, in future winters.

The "Time series of upper free troposphere observations from a European ground-based FTIR network"-project (UFTIR) integrated existing time series of ground-based remote sensing measurements by FTIR spectrometers with model studies, for investigating long-term changes of greenhouse gases and O_3 precursors in the troposphere. The target gases are N_2O , CH_4 , O_3 , HCFC-22, CO, C_2H_6 . UFTIR addressed changes in the chemical composition of the free troposphere and climate change over Europe. Understanding these changes, especially in the upper free troposphere, is indispensable to predict the future evolution of stratospheric O_3 . UFTIR contributed to the scientific verification of national and EU climate change strategies, and the Kyoto and Montreal Protocols and Amendments, paving the way towards sustainable development. All instruments

involved were operated as part of the NDSC. To achieve the objectives, a new FTIR retrieval strategy was developed and implemented in the UFTIR network. UFTIR delivered time series of the target tropospheric and stratospheric column abundances, quantitative trend estimates of the troposphere abundances, and improved model assessments of the evolution of greenhouse gases, to support upcoming troposphere satellite missions.

The Healing of the Ozone Layer: a Success Story

According to the new Scientific Assessment of Ozone Depletion to be available in 2015, the stratospheric ozone layer is on track for recovery towards the middle of this century. Thanks to successful implementation of the 1987 Montreal Protocol, the concentration of many Ozone Depleting Substances (ODSs) has significantly decreased. However, some substitutes to the CFCs are potent global warming gases. Their emissions grow at a rate of about seven per cent annually and they can be expected to “very significantly” affect climate change in the next decades.

Achim Steiner, the UN Under-Secretary-General and UNEP Executive Director stated recently that «The challenges that we face are still huge. The success of the Montreal Protocol should encourage further action not only on the protection and recovery of the ozone layer but also on climate».

OZONE AND CLIMATE CHANGES

Martine De Mazière

Stratospheric ozone plays an active role on climate change. The processes affecting stratospheric ozone and the links with climate are driven by complex feedback loops.

The Ozone-CCI project, coordinated by Michel Van Roozendael at BIRA-IASB, is part of the ESA Climate Change Initiative (CCI) Programme, initiated in 2010. This Programme has been set up to realize the full potential of European global satellite observational data sets contributing to Essential Climate Variables (ECVs) required by the United Nations Framework Convention on Climate Change (UNFCCC) and the International Panel on Climate Change (IPCC). Among the atmospheric ECVs are ozone, greenhouse gases and aerosols; BIRA-IASB is involved in all three related ESA projects.

The project “Ozone-CCI” aims at generating new high-quality satellite data sets that are essential to assess the fate of atmospheric ozone and better understand its link with anthropogenic activities and climate change. In particular, the project analyses the needs of the climate research community in terms of ozone data and adapts the ozone satellite measurements for their use by the climate research community.

Another important activity which is ongoing since 2009 and coordinated by Simon Chabrillat at BIRA-IASB is the “Stratospheric ozone service” (<http://www.copernicus-stratosphere.eu>) as part of the EU Monitoring Atmospheric Composition & Climate (MACC) project. The MACC project is the prototype of the Copernicus Atmospheric Monitoring Service (CAMS) and will provide key data products on atmospheric composition that will contribute to climate-change monitoring. It is a key European contribution to the Global Climate Observing System (GCOS) and the encompassing Global Earth Observation System of Systems (GEOSS).

The stratospheric ozone service delivers near-real time analyses of the stratospheric composition, with a focus on ozone, based on the assimilation of satellite data. It also provides historic long-term records comprising both total ozone columns and 3-dimensional gridded fields from data reanalyses starting in 1978.

Selected References

Lefever, K., R. van der A, F. Baier, Y. Christophe, Q. Errera, H. Eskes, J. Flemming, A. Inness, L. Jones, J.-C. Lambert, B. Langerock, M. G. Schultz, O. Stein, A. Wagner and S. Chabrillat (2014), Copernicus atmospheric service for stratospheric ozone: validation and intercomparison of four near real-time analyses, 2009-2012, *Atmospheric Chemistry and Physics Discussions*, 14(8), 12461-12523, doi:10.5194/acpd-14-12461-2014.

Sinnhuber, B.-M., D.W. Arlander, H. Bovensmann, J. P. Burrows, M. P. Chipperfield, C.-F. Enell, U. Frieß, F. Hendrick, P.V. Johnston, R. L. Jones, K. Kreher, N. Mohamed-Tahrin, R. Müller, K. Pfeilsticker, U. Platt, J.-P. Pommereau, I. Pundt, A. Richter, A. M. South, K. K. Tørnkvist, M. Van Roozendael, T. Wagner and F. Wittrock (2002), Comparison of measurements and model calculations of stratospheric bromine monoxide, *Journal of Geophysical Research: Atmospheres*, 107(D19), ACH 11-1-ACH 11-18, doi:10.1029/2001JD000940.

Sofieva, V. F., N. Rahpoe, J. Tamminen, E. Kyrölä, N. Kalakoski, M. Weber, A. Rozanov, C. von Savigny, A. Laeng, T. von Clarmann, G. Stiller, S. Lossow, D. Degenstein, A. Bourassa, C. Adams, C. Roth, N. Lloyd, P. Bernath, R. J. Hargreaves, J. Urban, D. Murtagh, A. Hauchecorne, F. Dalaudier, M. van Roozendael, N. Kalb and C. Zehner (2013), Harmonized dataset of ozone profiles from satellite limb and occultation measurements, *Earth System Science Data*, 5(2), 349-363, doi:10.5194/essd-5-349-2013.

Van Roozendael, M., C. Fayt, D. Bolsée, P. C. Simon, M. Gil, M. Yela and J. Cacho (1994), Ground-based stratospheric NO₂ monitoring at Keflavik (Iceland) during EASOE, *Geophysical Research Letters*, 21(13), 1379-1382, doi:10.1029/93GL02433.

Van Roozendael, M., C. Hermans, M. De Mazière and P. C. Simon (1994), Stratospheric NO₂ observations at the Jungfraujoch Station between June 1990 and May 1992, *Geophysical Research Letters*, 21(13), 1383-1386, doi:10.1029/93GL02432.

Van Roozendael, M., C. Hermans, Y. Kabbadj, J.-C. Lambert, A.-C. Vandaele, P. C. Simon, M. Carleer, J.-M. Guilmot and R. Colin (1995), Ground-based measurements of stratospheric OClO, NO₂ and O₃ at Harestua, Norway (60°N, 10°E) during SESAME, in *Proceedings of the 12th ESA Symposium on European Rocket and Balloon Programmes and Related Research*, Lillehammer, Norway, 29 May-1 June 1995, ESA SP-370, edited by Kaldeich-Schürmann, B., pp. 305-310, ESA Publications Division, Noordwijk, The Netherlands.

Van Roozendael, M., P. Peeters, P. C. Simon, H. K. Roscoe, A. Jones, L. M. Bartlett, G. Vaughan, F. Goutail, J.-P. Pommereau, E. Kyrö, C. Wahlstrøm and G. Braathen (1996), Absolute calibration of SAOZ measurements of ozone by comparison with Dobson and Brewer instruments, in *Polar stratospheric ozone: proceedings of the third European Workshop*, 18-22 September 1995, Schliersee, Bavaria, Germany, edited by Pyle, J. A., N. R. P. Harris and G. T. Amanatidis, pp. 521-526, Office for Official Publications of the European Communities, Luxembourg.

Van Roozendael, M., G. Vaughan, A. Engel, S. Godin, H. Jäger, E. Kyrö, B. Naujokat, C. Schiller, A. Weiss and R. Zander (2001), Chapter 2: Long-term Changes, in *European research in the stratosphere, 1996-2000: Advances in our understanding of the ozone layer during THESEO*, edited by Amanatidis, G. T. and N. R. P. Harris, pp. 29-67, Office for Official Publications of the European Communities, Luxembourg.

Important historical publications

Amanatidis, G. T. and N. R. P. Harris (Eds.) (2001), *European research in the stratosphere, 1996-2000: Advances in our understanding of the ozone layer during THESEO*, Office for Official Publications of the European Communities, Luxembourg.

European Commission, Directorate-General XII, Science, Research, and Development (Eds.) (1997), *European research in the stratosphere: The contribution of EASOE and SESAME to our current understanding of the ozone layer*, Office for Official Publications of the European Communities, Luxembourg.

Farman, J. C., B. G. Gardiner and J. D. Shanklin (1985), Large losses of total ozone in Antarctica reveal seasonal ClO_x/NO_x interaction, *Nature*, 315, 207-210, doi:10.1038/315207a0.

Molina, M. J. and F. S. Rowland (1974), Stratospheric sink for chlorofluoromethanes: chlorine atom-catalysed destruction of ozone, *Nature*, 249, 810-812, doi:10.1038/249810a0.

Rowland, F. S. and M. J. Molina (1975), Chlorofluoromethanes in the environment, *Reviews of Geophysics*, 13(1), 1-35, doi:10.1029/RG013i001p00001.

Solomon, S., (1988), The mystery of the Antarctic Ozone “Hole”, *Reviews of Geophysics*, 26(1), 131-148, doi:10.1029/RG026i001p00131.

Stolarski, R. S. and R. J. Cicerone (1974), Stratospheric Chlorine: a Possible Sink for Ozone, *Canadian Journal of Chemistry*, 52(8), 1610-1615, doi:10.1139/v74-233.

Website

QUILT
<http://nadir.nilu.no/quilt/index.php/>

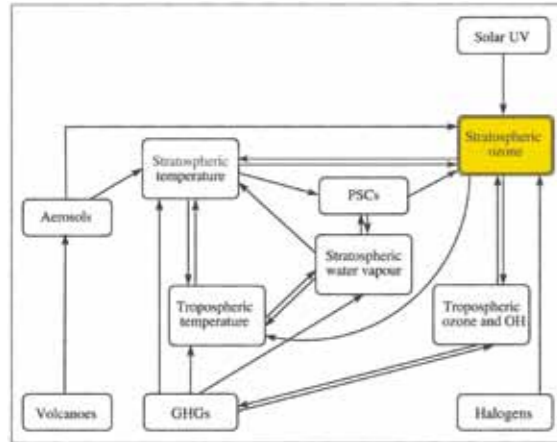

Schematic diagram of the principal processes affecting stratospheric ozone and the links with climate. (credit: European Commission)

10



BELEGCH INSTITUUT VOOR RUIMTE-AERONOMIE (BIRA) INSTITUUT D'AERONOMIE SPATIALE DE BELGIQUE (IASB) BELGIAN INSTITUTE FOR SPACE AERONOMY (BIRA-IASB) BELGIECH INSTITUUT VOOR RUIMTE-AERONOMIE (BIRA) INSTITUUT D'AERONOMIE SPATIALE DE BELGIQUE (IASB)

GROUND-BASED OBSERVATIONS

Martine De Mazière and Michel Van Roozendaal



The International Scientific Station of the Jungfrauoch (Switzerland, latitude: 46.6°N, altitude: 3 471 m). (credit: VicMadrid)

Martine De Mazière, Michel Van Roozendaal, Crist Amelynck and Hervé Lamy

Systematic monitoring and observation of the environment is a prerequisite for the quantification of atmospheric processes, for providing the basis to understand how and why changes are occurring, and for verification of regulations and Protocols like the Montreal and Kyoto Protocols. The need for an integrated atmospheric observing system, consisting of satellite, airborne and ground-based observations has been advocated already during the International Geophysical Year in 1958, and this need is still there, more than ever, as we recognize the links between climate changes, stratospheric ozone changes and air quality.

Ground-based observations play an essential role in the integrated observing system, for the following reasons:

1. They provide the required high-quality, long-term records of atmospheric parameters.
2. They are essential for the validation of the satellite data.
3. They are crucial for the verification of the scientific conclusions drawn from satellite data, like trends, climatologies, etc.
4. They are essential to bridge gaps between successive satellite data records.
5. They provide access to more local phenomena, like lower planetary boundary layer phenomena, and provide additional vertical information that is not easily accessible from satellites, like vertical profiles in the troposphere, and such on a more continuous basis than would be achieved with classical aircrafts or balloons.

Ground-based observations are most useful if they are performed network-wise, with controlled network consistency and quality.

Several global networks exist nowadays, for remote-sensing observations, like the Dobson and Brewer networks, the Network for the Detection of Atmospheric Composition Changes (NDACC) and the Total Carbon Column

Observing Network (TCCON), as well as for in situ surface observations, like the WMO-Global Atmosphere Watch (WMO-GAW) and ICOS (Integrated Carbon Observing System) networks.

BRAMS (Belgian RAdio Meteor Stations) is a unique network developed by BIRA-IASB using forward scattering of radio waves to detect and study meteoroids falling into the upper atmosphere. It will complement optical networks currently in development in neighbouring countries such as FRIPON (in France) and CAMS (in Benelux) in an effort to better understand the origin of meteoroids, their mass and speed distributions, and their impact on the upper atmosphere chemistry.

This does of course not exclude the interest of making individual ground-based observations for local process studies, like the exchange of reactive trace gases between the atmosphere and particular terrestrial ecosystems, aiming at a better parameterization of these exchange fluxes and allowing the validation of trace gas emission modules in atmospheric chemistry and climate models.

Related to ground-based observations are observations that are locally performed using balloons or unmanned aerial vehicles (UAVs). Such observational approaches are highly complementary to ground-based networks, providing additional high resolution information on the vertical and/or horizontal distribution of atmospheric trace gases. They are particularly useful to better characterize the impact of the local variability and atmospheric transport on the interpretation of both ground-based and satellite observations.

The following sections focus on the networks and types of ground-based observations in which BIRA-IASB has been or is still involved intensively.

THE NETWORK FOR THE DETECTION OF ATMOSPHERIC COMPOSITION CHANGE

Martine De Mazière, Michel Van Roozendael and Jean-Christopher Lambert
with contributions from François Hendrick, Bavo Langerock, Corinne Vigouroux and Christian Hermans

The Network for Detection of Atmospheric Composition Change (NDACC) has officially started in January 1991, under the name NDSC, Network for the Detection of Stratospheric Change, following a preparation period of 5 years for planning, instrument design and implementation.

It has been endorsed by the United Nations Environment Programme (UNEP), by the International Ozone Commission (IO3C) of the International Association of Meteorology and Atmospheric Physics, and by the World Meteorological Organization (WMO) as a major contributor to WMO's Global Atmosphere Watch (GAW) Programme.

From the very beginning, Belgium has played an important role in the Network, with the active involvement of Rodolphe Zander (ULg) in the Network inception, initiated in Boulder in 1986. The International Scientific Station of the Jungfraujoch (ISSJ) has always been a key station in the Network because of its historical time series of infrared atmospheric observations, which started almost 40 years before the Network.

In February 2006, the NDSC changed its name to NDACC, Network for Detection of Atmospheric Composition Change, to emphasize that its priorities have broadened considerably from monitoring changes in the stratosphere with an emphasis on the long-term evolution of the ozone layer; to also encompass issues such as the detection of trends in atmospheric composition, the understanding of their impacts on both the stratosphere and troposphere, and the assessment of links between climate change and atmospheric composition.

At present, NDACC represents a set of more than 70 high-quality, remote-sensing research stations/sites for observing and understanding the physical/chemical state of the stratosphere and troposphere, and for assessing the impact of stratospheric changes on the underlying troposphere and on global climate.

Its objectives are:

1. To study the temporal and spatial variability of atmospheric composition and structure
2. To provide early detection and subsequent long-term monitoring of changes in the chemical and physical state of the stratosphere and troposphere, thereby providing the means to discern and understand the causes of such changes

3. To establish the links between changes in stratospheric O₃, UV radiation at the ground, tropospheric chemistry, and climate
4. To provide independent validation, calibration, and complementary data for space-based sensors of the atmosphere
5. To support process-study field campaigns occurring at various latitudes and seasons.
6. To provide verified data for testing and improving multidimensional chemistry and transport models of the stratosphere and troposphere, thus enabling reliable forecasting of the atmosphere's evolution.

NDACC can therefore play a major role in supporting international Protocols, like the Montreal and Kyoto Protocols, from their development to their verification.

The NDACC operational structure consists of the NDACC Steering Committee and the NDACC Science Team, which is structured according to Working Groups per instrument type, like the Infrared and the UV-visible Working Groups, per scientific theme, per specific activity like satellite validation or modelling, or ad hoc (e.g., Working Group on future measurement strategies and emphases).

Since the start of NDACC, Belgian scientists have been involved in the direction of NDACC as co-chairperson (Rodolphe Zander, Paul C. Simon, and Martine De Mazière), or Working Group co-chairpersons (Rodolphe Zander, Martine De Mazière, Jean-Christopher Lambert and Michel Van Roozendael).

Between 1990 and 2000, BIRA-IASB coordinated five EU projects related to the implementation of the NDSC, which have played an active role in developing and improving several important aspects of the instrumental techniques used within the network in Europe. They contributed to the achievement of reliable operation of a series of specific instrument types, and to our understanding of the ozone loss in the Arctic by contributing to the European Arctic campaigns SESAME and THESEO (see chapter 9).

Another important achievement was the initiation of the harmonization of data formats for the NDACC data, based on the Hierarchical Data Format (HDF). Since then, BIRA-IASB has taken the lead in the further development and improvement of the implementation of the HDF format within NDACC.

More recently, BIRA-IASB has been coordinating the EU FP7 project NORS, Demonstration Network Of ground-based Remote Sensing Observations in support of the Copernicus (GMES) Atmosphere Monitoring Service. This project includes the four main instrument techniques of NDACC (ozone lidar, microwave radiometry, infrared and UV-visible spectrometry) and has two major general objectives: to create new and optimized NDACC data for supporting the quality assessment of the Copernicus Atmosphere Monitoring Service, and to develop a generic and operational validation service using the NDACC data.

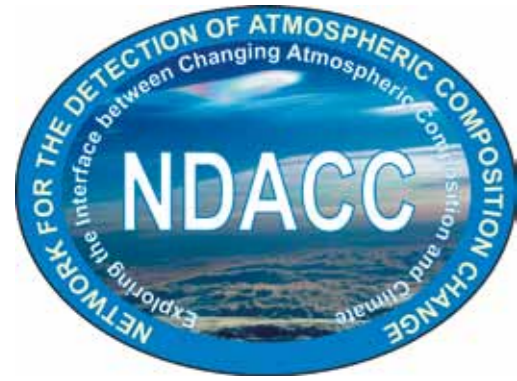

The seven stations in which BIRA-IASB is actively involved are indicated as black dots on the map of the NDACC network (2014).

The Infrared Working Group of NDACC

The Infrared Working Group (IRWG) is coordinating the ground-based infrared spectrometers that are affiliated to the Network. It is required that these are high-resolution Fourier-transform Infrared spectrometers (FTIR), operated according to a protocol defined by the working group. The data processing must also adhere to strict quality requirements.

The ISSJ operated by the Université de Liège (ULg) has been one of the first stations in the Network equipped with an FTIR instrument. BIRA-IASB started a collaboration with ULg in 1990 to operate their FTIR instrument at the ISSJ and to jointly analyse the data. At the same time, BIRA-IASB started to develop its own data processing algorithms and participated in an algorithm intercomparison campaign organized by the IRWG in 1994.

The IRWG algorithms evolved from algorithms for the retrieval of total column abundances to algorithms for the retrieval of vertical profile information using optimal estimation inversion techniques. An international "Workshop on inverse methods and the inversion algorithm" with the IRWG members and organized by BIRA-IASB, led to the evolution of the standard code for total column retrieval in the IRWG to the standard IRWG code for vertical profile retrievals.

Around 2000, the idea rose to acquire an FTIR instrument at BIRA-IASB and to install it at Ile de La Réunion, the only southern hemisphere subtropical site in the Network. The first FTIR measurements at Ile de La Réunion by BIRA-IASB were carried out during a campaign in 2002, in collaboration with the Université Libre de Bruxelles. Since then, several campaigns have been conducted and since May 2009, the instrument is operated permanently.

Researchers affiliated to the IRWG commit themselves to the regular submission to the database of total column abundances and vertical profile information for 10 atmospheric constituents: O_3 , HCl, HF, ClONO₂, HNO₃, CH₄, N₂O, CO, C₂H₆, and HCFC-22. But the FTIR technique allows many more molecules to be detected and quantified. For example, at Ile de La Réunion, we have been able to retrieve time series of many volatile organic compounds, like formaldehyde (HCHO), methanol (CH₃OH), acetylene (C₂H₂), formic acid (HCOOH), ... These data have been used, among others, to support the assessment of tropospheric chemistry-transport models like IMAGES and GEOS-chem, and to support satellite data validation. They have also indicated the importance at Ile de La Réunion of the impact of biomass burning emissions above Africa and even South America.

The IRWG invested in a better characterisation and harmonisation of vertical profile retrievals, first for a limited number of target species during a European project coordinated by BIRA-IASB, later for the ten mandatory

constituents listed above. This work is important because, even if the retrieval codes are standardized, retrieval settings can be very different from one site in the network to another, jeopardizing the network consistency. It is the intention to finalise this effort in the coming years with a peer-reviewed publication.

Thanks to these developments, the IRWG could contribute significantly to the assessment of trends in the vertical distribution of ozone: the effort was led by Corinne Vigouroux of BIRA-IASB, and resulted in several publications and contributions to the WMO Scientific Assessments of Ozone Depletion 2010 and 2014. The BIRA-IASB team is also playing an important role in the development of methodologies and tools for the evaluation of the uncertainty budgets associated with the NDACC IRWG data products. The latest release of the IRWG standard retrieval code (2014) includes routines developed by the BIRA-IASB team.

The UV-Visible Working Group of NDACC

The UV-Visible Working Group (UVVISWG) coordinates the ground-based UV-visible instruments that are affiliated to the Network. Developed in the late eighties, the zenith-sky UV-visible spectroscopy has been used for unattended daily monitoring of stratospheric ozone and related gases such as NO₂, BrO and OClO. More recently, this technique has been extended to the monitoring of the tropospheric composition by means of the so-called MAXDOAS geometry (see Section 10.4), which in addition to stratospheric gases also enables columns and surface concentrations of a number of important tropospheric species to be measured, such as BrO, NO₂, HCHO, CHOCHO, IO, O₃, SO₂, and aerosols. Instruments affiliated to the network are validated and quality controlled according to protocols endorsed by the community. In addition, instrument intercomparison campaigns are organized every few years to promote scientific improvements and provide opportunities for certification of new groups.

The involvement of BIRA-IASB in stratospheric UV-visible monitoring activities started in 1990 with the installation of a SAOZ instrument at the ISSJ provided by Jean-Pierre Pommereau (LATMOS, formerly Service



Maito scientific station at "Ile de La Réunion" (France-"Département d'Outre-Mer"). Recently, the FTIR has been installed here for permanent operation (elevation: 2200m above sea level).

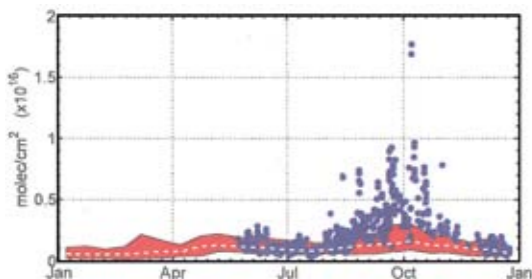

Formic acid measurements obtained at Ile de La Réunion (France) during the 2004, 2007 and 2009 FTIR campaigns (blue dots), compared with model results (red). The average simulated value is represented by the dashed white line. (Figure adapted from Paulot et al, 2011).



DOAS instrument at OHP (France, latitude 44°N).



SAOZ instrument at the International Scientific Station of the Jungfraujoch

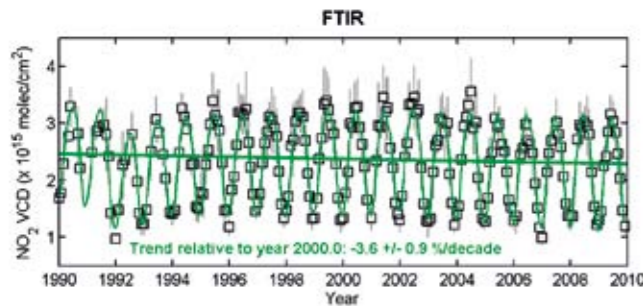
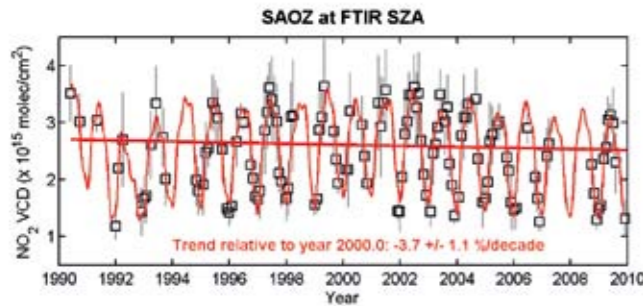

Nitrogen dioxide total content obtained from SAOZ and FTIR observations from 1990 to 2010 at the International Scientific Station of the Jungfraujoch. Deduced long-term trends are indicated.

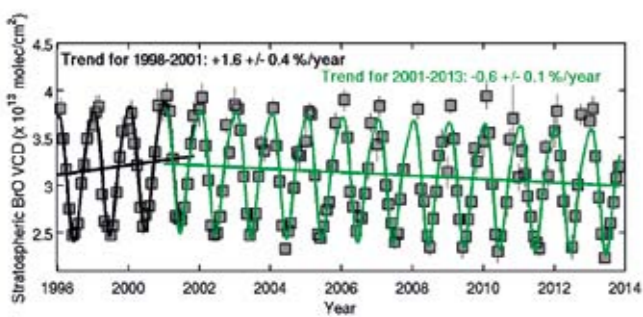

Time series of BrO stratospheric total content in Harestua (Norway, 60°N), since 1998, showing the negative trend starting around 2001

d'Aéronomie, CNRS). This instrument, still in operation today, has provided time-series of ozone and NO₂ observations covering more than two decades allowing for long-term trends analysis. In the course of the nineties, these measurements were complemented by two additional sites located respectively in Harestua, Norway (60°N) and at the Observatoire de Haute Provence, France (44°N). At both sites, the focus was on establishing a capacity for monitoring the evolution of the stratospheric bromine load. This culminated in 2008 in the publication of a trend analysis demonstrating the impact of the Montreal Protocol on ozone depleting substances on stratospheric bromine.

In the same period, BIRA-IASB also actively participated to all UV-visible intercomparison campaign exercises held as part of the Network. These were successively organized in Lauder (New-Zealand) in 1992, Observatoire de Haute Provence (France) in 1996, Andoya (Norway) in 2003 and Cabauw (The Netherlands) in 2008.

In more recent years, our interest further evolved from stratospheric ozone research to the study of the tropospheric composition, with a particular focus on halogens and short-lived air quality gases. Such developments were also motivated by the need to validate new atmospheric composition satellite sensors such as SCIAMACHY, OMI and GOME-2. In 2008 a state-of-the-art MAXDOAS instrument was designed and installed in Beijing to monitor the air quality during the Olympic Games. This instrument was subsequently moved to the sub-urban site of Xianghe (East of Beijing) for long-term operation in collaboration with the Institute of Atmospheric Physics of the Chinese Academy of Sciences. Using this system, the variability of aerosols and key pollutants such as NO₂, SO₂, HCHO, and HONO were characterized over the period from 2008 until 2013. In 2010, a similar system was installed at the ISSJ, and in 2013, this was further complemented by a MAXDOAS instrument operated in the Central African site of Bujumbura, Burundi.

Besides monitoring activities, the BIRA-IASB team has also played an important role in the development of data retrieval methods and tools. In particular BIRA has designed the QDOAS analysis software which nowadays constitutes a reference tool in the UV-visible community and has been distributed worldwide in over 100 universities and research groups.

Selected References

Duflot, V., B. Dils, J. L. Baray, M. De Mazière, J. L. Attié, G. Vanhaelewyn, C. Senten, C. Vigouroux, G. Clain and R. Delmas (2010), Analysis of the origin of the distribution of CO in the subtropical southern Indian Ocean in 2007, *Journal of Geophysical Research: Atmospheres*, 115(D22), D22106, doi:10.1029/2010JD013994.

Duflot, V., D. Hurtmans, L. Clarisse, Y. R'honi, C. Vigouroux, M. De Mazière, E. Mahieu, C. Servais, C. Clerbaux and P.-F. Coheur (2013), Measurements of hydrogen cyanide (HCN) and acetylene (C₂H₂) from the Infrared Atmospheric Sounding Interferometer (IASI), *Atmospheric Measurement Techniques*, 6(4), 917-925, doi:10.5194/amt-6-917-2013.

Hassler, B., I. Petropavlovskikh, J. Staehelin, T. August, P. K. Bhartia, C. Clerbaux, D. Degenstein, M. De Mazière, B. M. Dinelli, A. Dudhia, G. Dufour, S. M. Frith, L. Froidevaux, S. Godin-Beekmann, J. Granville, N. R. P. Harris, K. Hoppel, D. Hubert, Y. Kasai, M. J. Kurylo, E. Kyrölä, J.-C. Lambert, P. F. Levelt, C. T. McElroy, R. D. McPeters, R. Munro, H. Nakajima, A. Parrish, P. Raspollini, E. E. Remsburg, K. H. Rosenlof, A. Rozanov, T. Sano, Y. Sasano, M. Shiotani, H. G. J. Smit, G. Stiller, J. Tamminen, D. W. Tarasick, J. Urban, R. J. van der A, J. P. Veefkind, C. Vigouroux, T. von

Clarmann, C. von Savigny, K. A. Walker, M. Weber, J. Wild and J. M. Zawodny (2014), Past changes in the vertical distribution of ozone - Part 1: Measurement techniques, uncertainties and availability, *Atmospheric Measurement Techniques*, 7(5), 1395-1427, doi:10.5194/amt-7-1395-2014.

Hendrick, F., P. V. Johnston, M. De Mazière, C. Fayt, C. Hermans, K. Kreher, N. Theys, A. Thomas and M. Van Roozendael (2008), One-decade trend analysis of stratospheric BrO over Harestua (60°N) and Lauder (45°S) reveals a decline, *Geophysical Research Letters*, 35(14), L14801, doi:10.1029/2008GL034154.

Hendrick, F., E. Mahieu, G. E. Bodeker, K. F. Boersma, M. P. Chipperfield, M. De Mazière, I. De Smedt, P. Demoulin, C. Fayt, C. Hermans, K. Kreher, B. Lejeune, G. Pinardi, C. Servais, R. Stübi, R. van der A, J.-P. Vernier and M. Van Roozendael (2012), Analysis of stratospheric NO₂ trends above Jungfraujoch using ground-based UV-visible, FTIR, and satellite nadir observations, *Atmospheric Chemistry and Physics*, 12(18), 8851-8864, doi:10.5194/acp-12-8851-2012.

Paulot, F., D. Wunch, J. D. Crouse, G. C. Toon, D. B. Millet, P. F. DeCarlo, C. Vigouroux, N. M. Deutscher, G. González Abad, J. Notholt, T. Warneke, J. W. Hannigan, C. Warneke, J. A. de Gouw, E. J. Dunlea, M. De Mazière, D. W. T. Griffith, P. Bernath, J. L. Jimenez and P. O. Wennberg (2011), Importance of secondary sources in the atmospheric budgets of formic and acetic acids, *Atmospheric Chemistry and Physics*, 11(5), 1989-2013, doi:10.5194/acp-11-1989-2011.

Senten, C., M. De Mazière, B. Dils, C. Hermans, M. Kruglanski, E. Neefs, F. Scolas, A. C. Vandaele, G. Vanhaelewyn, C. Vigouroux, M. Carleer, P. F. Coheur, S. Fally, B. Barret, J. L. Baray, R. Delmas, J. Leveau, J. M. Metzger, E. Mahieu, C. Boone, K. A. Walker, P. F. Bernath and K. Strong (2008), Technical Note: Ground-based FTIR measurements at Ile de La Réunion: Observations, error analysis and comparisons with satellite data, *Atmospheric Chemistry and Physics*, 8(13), 3483-3508, doi:10.5194/acp-8-3483-2008.

Stavrakou, T., A. Guenther, A. Razavi, L. Clarisse, C. Clerbaux, P.-F. Coheur, D. Hurtmans, F. Karagulian, M. De Mazière, C. Vigouroux, C. Amelynck, N. Schoon, Q. Laffineur, B. Heinesch, M. Aubinet, C. Rinsland and J.-F. Müller (2011), First space-based derivation of the global methanol emission fluxes, *Atmospheric Chemistry and Physics*, 11(10), 4873-4898, doi:10.5194/acp-11-4873-2011.

Van Roozendael, M., M. De Mazière and P. C. Simon (1994), Ground-based visible measurements at the Jungfraujoch station since 1990, *Journal of Quantitative Spectroscopy and Radiative Transfer*, 52(3-4), 231-240, doi:10.1016/0022-4073(94)90153-8.

Vigouroux, C., M. De Mazière, P. Demoulin, C. Servais, F. Hase, T. Blumenstock, I. Kramer, M. Schneider, J. Mellqvist, A. Strandberg, V. Velasco, J. Notholt, R. Sussmann, W. Stremme, A. Rockmann, T. Gardiner, M. Coleman and P. Woods (2008), Evaluation of tropospheric and stratospheric ozone trends over Western Europe from ground-based FTIR network observations, *Atmospheric Chemistry and Physics*, 8(23), 6865-6886, doi:10.5194/acp-8-6865-2008.

Vigouroux, C., F. Hendrick, T. Stavrakou, B. Dils, I. De Smedt, C. Hermans, A. Merlaud, F. Scolas, C. Senten, G. Vanhaelewyn, S. Fally, M. Carleer, J.-M. Metzger, J.-F. Müller, M. Van Roozendael and M. De Mazière (2009), Ground-based FTIR and MAX-DOAS observations of formaldehyde at Réunion Island and comparisons with satellite and model data, *Atmospheric Chemistry and Physics*, 9(24), 9523-9544, doi:10.5194/acp-9-9523-2009.

Vigouroux, C., T. Stavrakou, C. Whaley, B. Dils, V. Duflot, C. Hermans, N. Kumps, J.-M. Metzger, F. Scolas, G. Vanhaelewyn, J.-F. Müller, D. B. A. Jones, Q. Li and M. De Mazière, FTIR time-series of biomass burning products (HCN, C₂H₆, C₂H₂, CH₃OH, and HCOOH) at Reunion Island (21° S, 55° E) and comparisons with model data, *Atmospheric Chemistry and Physics*, 12(21), 10367-10385, doi:10.5194/acp-12-10367-2012.



Harestua station (Norway, latitude 60°N).



MAXDOAS instrument installed in Beijing from June 2008 to April 2009 on the roof of the Institute for Atmospheric Physics (China).

Websites

Network for Detection of Atmospheric Composition Change:
<http://www.ndacc.org>

The NDACC data are hosted at NOAA in the NDACC database and can be accessed via the ftp server
<ftp://ftp.cpc.ncep.noaa.gov/ndacc>

More info on the QDOAS analysis software:
<http://uv-vis.aeronomie.be/software/QDOAS/index.php>

THE TOTAL CARBON COLUMN OBSERVING NETWORK (TCCON).

Martine De Mazière and Filip Desmet
With contributions from Bart Dils and Christian Hermans

In 2011, BIRA-IASB installed a second FTIR spectrometer of the latest generation (Bruker 125 HR) at St. Denis (Ile de La Réunion) for solar absorption observations in the near-infrared with the goal to accurately and precisely measure the abundance of greenhouse gases (CO_2 , CH_4 , N_2O , H_2O , CO ...). These measurements contribute to the international Total Carbon Column Observing Network (TCCON). This network was established in 2004 for the validation of the Orbiting Carbon Observatory (OCO), a NASA spacecraft dedicated to studying atmospheric carbon dioxide. Today, it is used extensively for the validation of SCIAMACHY and GOSAT greenhouse gas data products. The TCCON site at Ile de La Réunion is one of the selected validation targets for OCO-2, which was launched on 2 July 2014. St. Denis is one of 19 sites worldwide which will be targeted regularly by the satellite with the aim of validating the greenhouse gas measurements from space. The accuracies and precisions achieved in the network are of the order of 0.25 % and 0.25%, respectively, for CO_2 and 0.4% and 0.3% for CH_4 . At present, we have time series of total column abundances of greenhouse gases at Ile de La Réunion, covering a period of three years. The data are archived in the TCCON database, accessible via the TCCON website.

Selected References

Buchwitz, M., M. Reuter, O. Schneising, H. Boesch, S. Guerlet, B. Dils, I. Aben, R. Armante, P. Bergamaschi, T. Blumenstock, H. Bovensmann, D. Brunner, B. Buchmann, J. P. Burrows, A. Butz, A. Chédin, F. Chevallier, C. D. Crevoisier, N. M. Deutscher, C. Frankenberg, F. Hase, O. P. Hasekamp, J. Heymann, T. Kaminski, A. Laeng, G. Lichtenberg, M. De Mazière, S. Noël, J. Notholt, J. Orphal, C. Popp, R. Parker, M. Scholze, R. Sussmann, G. P. Stiller, T. Warneke, C. Zehner, A. Bril, D. Crisp, D. W. T. Griffith, A. Kuze, C. O'Dell, S. Oshchepkov, V. Sherlock, H. Suto, P. Wennberg, D. Wunch, T. Yokota and Y. Yoshida (2013), The Greenhouse Gas Climate Change Initiative (GHG-CCI): Comparison and quality assessment of near-surface-sensitive satellite-derived CO_2 and CH_4 global data sets, Remote Sensing of Environment, Advanced online publication, doi:10.1016/j.rse.2013.04.024.

Dils, B., M. Buchwitz, M. Reuter, O. Schneising, H. Boesch, R. Parker, S. Guerlet, I. Aben, T. Blumenstock, J. P. Burrows, A. Butz, N. M. Deutscher, C. Frankenberg, F. Hase, O. P. Hasekamp, J. Heymann, M. De Mazière, J. Notholt, R. Sussmann, T. Warneke, D. Griffith, V. Sherlock and D. Wunch (2014), The Greenhouse Gas Climate Change Initiative (GHG-CCI): comparative validation of GHG-CCI SCIAMACHY/ENVISAT and TANSO-FTS/GOSAT CO_2 and CH_4 retrieval algorithm products with measurements from the TCCON, Atmospheric Measurement Techniques, 7(6), 1723-1744, doi:10.5194/amt-7-1723-2014.

Website

<https://tcon-wiki.caltech.edu/>



Map of the TCCON stations (2014).



FTIR spectrometer for ground-based atmospheric observations.

THE BELGIAN SOLAR UV-VISIBLE MONITORING NETWORK

Didier Gillotay

The significant stratospheric ozone depletion at mid and high latitudes in both hemispheres, confirmed at the end of the eighties by satellite and ground-based measurements, has led to a need for reliable measurements of the solar ultraviolet irradiance at the Earth's surface. Because the UV-B (280-315 nm) solar irradiance is strongly absorbed by stratospheric ozone, the global climatology of the UV irradiance at the surface will be affected by ozone variations and trends. The UV-B wavelength interval induces also photoreactions on biological systems. Therefore, it is important to quantify future UV-B changes on global and regional scales in order to investigate the potential modifications induced to the biosphere.

BIRA-IASB has been involved since the beginning in a series of European programmes in order to establish a European UV monitoring network and a European UV database. Principally based on spectral measurements, this network is still partially operational today. But without any more financial support from EU, the active partners in the network have to find support in their own countries, which can explain some defections.

On a regional scale, BIRA-IASB has established progressively a Belgian UV network in order to investigate the regional UV climatology of the five most significant climatic areas of Belgium.

The first station, fully operational since March 1993, is deployed on the roof of the BIRA-IASB building in Uccle. This station allows:

1. Spectral measurements: rich in information but with a low temporal resolution
2. Integrated measurements: UV-B, UV-A, and total solar irradiance with a high temporal resolution (up to 1 measurement per second)
3. Quasi spectral measurements offering a good compromise between spectral resolution (6, 10 and 14 bands throughout the UV-visible range) and temporal resolution (about 1 measurement per minute)
4. Ancillary measurements such as meteorological parameters (temperature, pressure, relative humidity, wind speed and direction, rainfall, sunshine duration) and cloud parameters (cloud cover and altitude)

The important variety of instruments deployed in Uccle, and an experience of 10 years at this site, provided us the expertise to select the most adequate instruments to equip the five other stations of the network.

In 2004, a second station was deployed in Redu (Ardennes) on an instrument tower located at the Euro

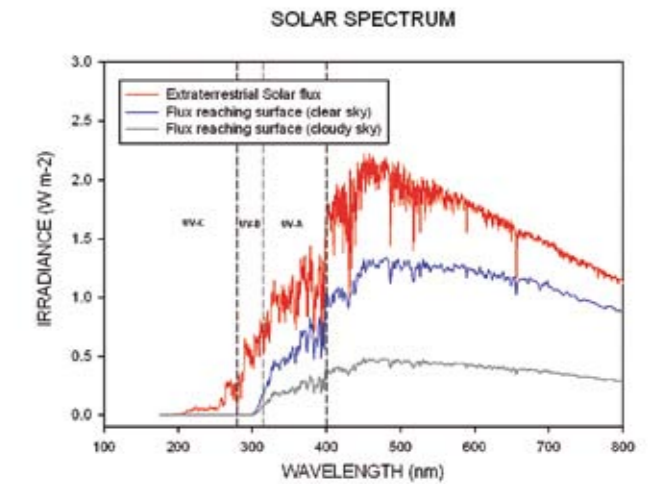

Solar spectra at the top of the atmosphere and at the surface, for clear sky and cloudy sky conditions, with the UV-A, -B and -C ranges. The cut-off of solar irradiances below 300 nm is due to stratospheric ozone.

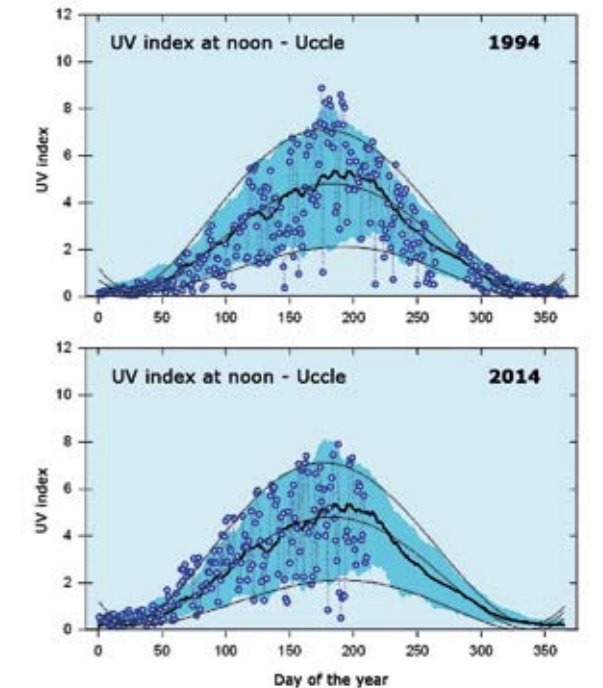

Example of daily measurement of the UV index at noon in 1994 and 2014, in Uccle.

Space Center. This station is equipped with 3 broadband instruments (for integrated measurements of UV-B, UV-A and total solar irradiance), one filter-radiometer (6 channels in UV + PAR channel, i.e. Photosynthetically Active Radiation, 400-700nm) for quasi spectral measurements, a meteorological station to provide the meteorological parameters and a cloud infrared radiometer to obtain the cloud cover and cloud ceiling. This set of instruments is the base of the new stations equipment.

Two years later, in 2006, a third station, with the same equipment as the second station, has been deployed in Ostend on the roof of the Earth Explorer facility (currently Explorado), representative of the climate at the Belgian coast.

In 2007 and 2008, two more stations were established respectively in Virton (Gaumes) on the roof of the City Hall and in Mol (Kempen) on top of the administrative building of VITO.

The last station of the Belgian network has been recently (2011) deployed at Mont Rigi at the "Station Scientifique des Hautes Fagnes".

A close contact with the station of Diekirch (Luxemburg) permitted to add this station in the Belgium-Luxemburg network.

Finally, three broadband instruments have been installed at the Antarctic Base Princess Elisabeth (Antarctica) since December 2012.

The data obtained since more than 20 years in Uccle have demonstrated the anti-correlation between stratospheric ozone and UV-B, the positive trends of UV-B irradiance, and the negative trends of the total ozone column. They contribute also to a better understanding of the UV climatology and the quantification of the most important factor that limits the penetration of solar UV radiation into the atmosphere down to the Earth's surface.

The regional UV climatology, based on climatic particularities of the area covered by our stations, is presently studied in detail but requires, mainly for the most recent stations, an extended period of measurement.

The Belgian UV monitoring network is presently fully operational and produces high quality data important for a better understanding of the UV climatology and the UV radiation transfer. A comprehensive description of the network, the instruments, the database, and the real time measurements, especially the UV index, is presented on our website. The prediction (24h) of the UV index in real atmospheric conditions is presently under development and should be available in the near future.

Website

<http://uvindex.aeronomie.be>

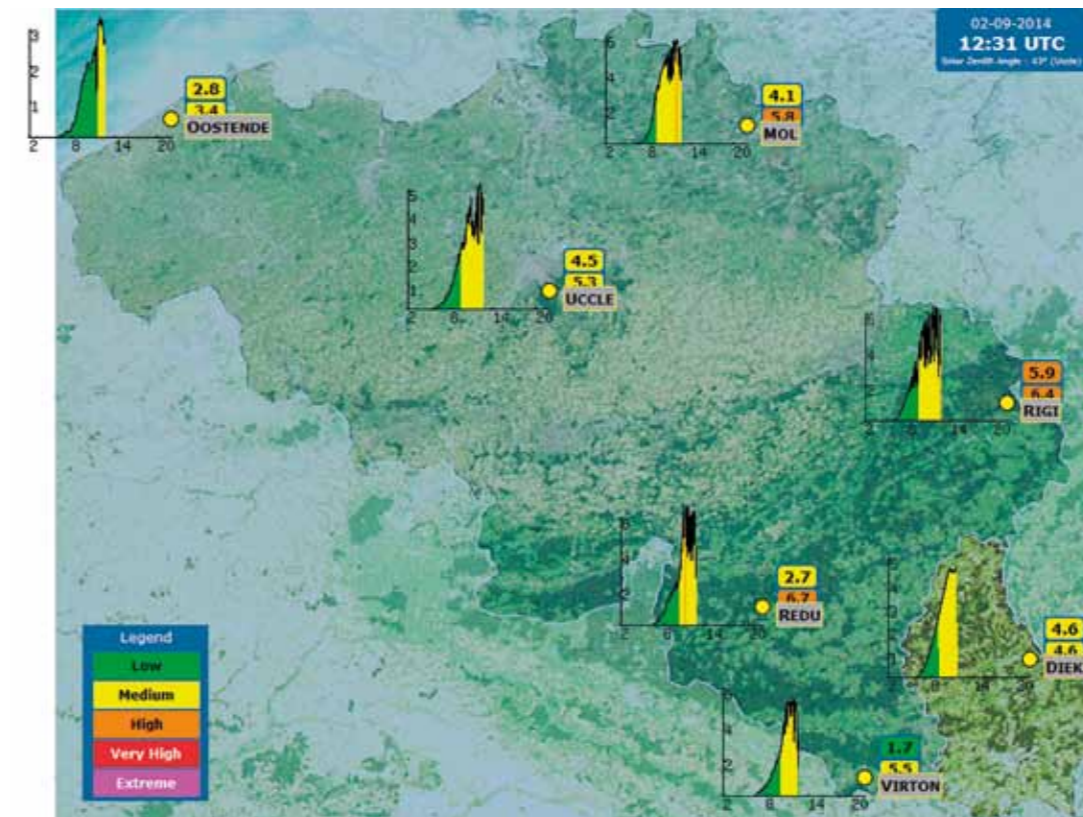

Map with the five stations of the Belgian UV network, representing the five most significant climatic areas of Belgium, and the Luxemburg station.

Selected References

De Backer, H., P. Koepke, A. Bais, X. de Cabo, T. Frei, D. Gillotay, C. Haite, A. Heikkilä, A. Kazantzidis, T. Koskela, E. Kyrö, B. Lapeta, J. Lorente, K. Masson, B. Mayer, H. Plets, A. Redondas, A. Renaud, G. Schaubberger, A. Schmalwieser, H. Schwander and K. Vanicek (2001), Comparison of measured and modelled uv indices for the assessment of health risks, *Meteorological Applications*, 8(3), 267-277, doi:10.1017/S1350482701003024.

Genkova, I., C. Long, T. Besnard and D. Gillotay (2004), Assessing cloud spatial and vertical distribution with cloud infrared radiometer CIR-7, *Proceedings of SPIE 5571, Remote Sensing of Clouds and the Atmosphere IX*, 241-249, doi:10.1117/12.564234.

Gillotay, D. and D. Bolsée (2003), 14 years of UV monitoring in Belgium: A first approach of the UV climatology, *Geophysical Research Abstracts*, 5, 14350.

Koepke, P., A. Bais, D. Balis, M. Buchwitz, H. De Backer, X. de Cabos, P. Eckert, P. Eriksen, D. Gillotay, A. Heikkilä, T. Koskela, B. Lapeta, Z. Litynska, J. Lorente, B. Mayer, A. Renaud, A. Ruggaber, G. Schaubberger, G. Seckmeyer, P. Seifert, A. Schmalwieser, H. Schwander, K. Vanicek and M. Weber (1988), Comparison of Models Used for UV Index Calculations, *Photochemistry and Photobiology*, 67(6), 657-662, doi:10.1111/j.1751-1097.1998.tb09109.x

Pandey, P., K. De Ridder, D. Gillotay and N. P. M. van Lipzig (2012), Estimating cloud optical thickness and associated surface UV irradiance from SEVIRI by implementing a semi-analytical cloud retrieval algorithm, *Atmospheric Chemistry and Physics*, 12(17), 7961-7975, doi:10.5194/acp-12-7961-2012.

TROPOSPHERIC TRACE GAS MONITORING USING MAXDOAS

Michel Van Roozendael and François Hendrick

With contributions from Christian Hermans, Caroline Fayt and Gaia Pinardi

Ground-based zenith-sky UV-visible instruments have been deployed within NDACC since the early nineties for the long-term monitoring of stratospheric ozone, NO₂, BrO and OCIO (see Section NDACC). With these instruments optimal sensitivity to the stratosphere is obtained by taking benefit of the favourable twilight geometry. To extend the capabilities of UV-visible instruments, and motivated by a progressive shift of interest within NDACC to address the study of the tropospheric composition, new instrumental and data retrieval developments have been initiated in the years 2000. This has led to the design of the so-called Multi-AXis DOAS (MAXDOAS) technique. By observing the sky at several elevations between horizon and zenith, MAXDOAS instruments can provide information on the vertical distribution of trace gases such as NO₂, HCHO, glyoxal, HONO, BrO, SO₂ and IO in the lower troposphere. In addition, since the light path of the scattered radiation is affected by particles, the aerosol extinction can be measured as well.

BIRA-IASB has been involved in the development of the MAXDOAS technique since more than a decade. Over the years, we have developed performant research-grade instruments as well as advanced retrieval methodologies for trace gases and aerosols, combining DOAS spectral fitting, radiative transfer simulations and optimal-estimation-based vertical profile inversion schemes. In 2008, a state-of-the-art MAXDOAS system was assembled at BIRA-IASB and installed in Beijing as part of a bi-lateral research agreement with the Institute of Atmospheric Physics at the Chinese Academy of Sciences (IAP/CAS, Beijing, China). Moved to Xianghe (~50 km East of Beijing) in 2010, it has been used to document the evolution and variability of several key atmospheric pollutants in North East China. Likewise, the high altitude International Scientific Station of Jungfraujoch (Swiss Alps) has been equipped for free-tropospheric MAXDOAS studies in 2010 and more recently a new monitoring activity has been started in Bujumbura (Burundi) for the study of African emissions. It is the intention to progressively upgrade all UV-visible monitoring sites operated by BIRA-IASB with similar systems.

Since it is based on a remote-sensing approach allowing for the simultaneous determination of total columns and vertical profiles, the MAXDOAS technique is ideally suited for satellite validation applications. Moreover MAXDOAS instruments provide observations averaged over a spatial extent that is more representative of the air masses sampled by satellite instruments than in-situ instruments. Based on our MAXDOAS sites, we have contributed to the validation of the successive GOME, SCIAMACHY, OMI and GOME-2 satellite sensors,



BIRA-IASB MAXDOAS instrument. The optical head is mounted on a sun tracking system allowing for alternate direct-sun and elevation scan measurement sequences.



Map of ground-based UV-visible sites operated by BIRA-IASB.

with particular focus on NO₂, SO₂, HCHO and BrO. Ongoing activities aim at extending the capabilities of MAXDOAS instruments for large scale satellite validation.

BIRA-IASB takes a leading role in coordinating such developments in the framework of ESA and EU projects. It is the ambition to promote and extend the MAXDOAS technique as one of the key validation tools for the future series of atmospheric Sentinel sensors that will be deployed in the next decade in support of the European Copernicus (previously Global Monitoring of Environment and Security) programme.

Selected References

Clémer, K., M. Van Roozendael, C. Fayt, F. Hendrick, C. Hermans, G. Pinardi, R. Spurr, P. Wang and M. De Mazière (2010), Multiple wavelength retrieval of tropospheric aerosol optical properties from MAXDOAS measurements in Beijing, *Atmospheric Measurement Techniques*, 3(4), 863-878, doi:10.5194/amt-3-863-2010.

Hendrick, F., J.-F. Müller, K. Clémer, P. Wang, M. De Mazière, C. Fayt, C. Gielen, C. Hermans, J. Z. Ma, G. Pinardi, T. Stavrou, T. Vlemmix and M. Van Roozendael (2014), Four years of ground-based MAX-DOAS observations of HONO and NO₂ in the Beijing area, *Atmospheric Chemistry and Physics*, 14(2), 765-781, doi:10.5194/acp-14-765-2014.

Pinardi, G., M. Van Roozendael, N. Abuhassan, C. Adams, A. Cede, K. Clémer, C. Fayt, U. Frieß, M. Gil, J. Herman, C. Hermans, F. Hendrick, H. Irie, A. Merlaud, M. Navarro Comas, E. Peters, A. J. M. Piers, O. Puentedura, A. Richter, A. Schönhardt, R. Shaiganfar, E. Spinei, K. Strong, H. Takashima, M. Vrekoussis, T. Wagner, F. Wittrock and S. Yilmaz (2013), MAX-DOAS formaldehyde slant column measurements during CINDI: intercomparison and analysis improvement, *Atmospheric Measurement Techniques*, 6(1), 167-185, doi:10.5194/amt-6-167-2013.

Wang, T., F. Hendrick, P. Wang, G. Tang, K. Clémer, H. Yu, C. Fayt, C. Hermans, C. Gielen, G. Pinardi, N. Theys, H. Brenot and M. Van Roozendael (2014), Evaluation of tropospheric SO₂ retrieved from MAX-DOAS measurements in Xianghe, China, *Atmospheric Chemistry and Physics Discussions*, 14(5), 6501-6536, doi:10.5194/acpd-14-6501-2014.

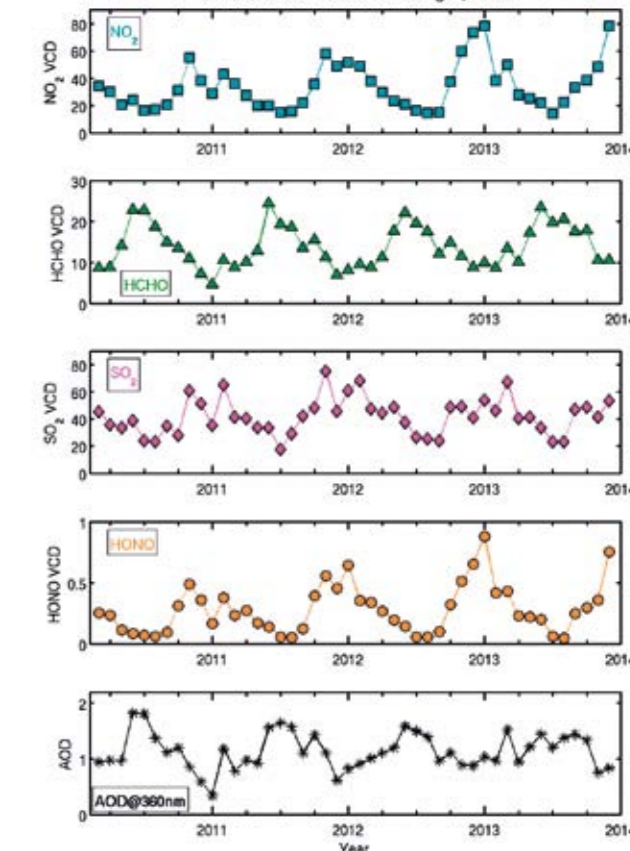

Time-series of the monthly averaged daytime NO₂, HCHO, SO₂, HONO vertical column densities (VCDs; expressed in 10¹⁵ molec/cm²) and aerosol optical depth (AOD) retrieved from MAXDOAS measurements at Xianghe, China.

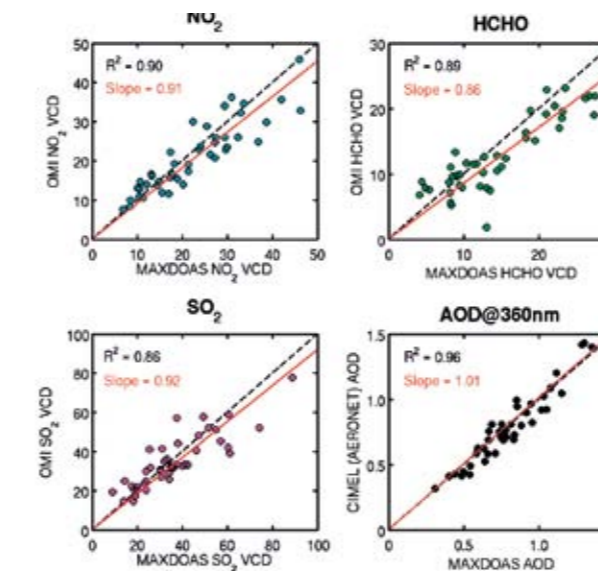

Illustration of comparison results between MAXDOAS measurements of NO₂, HCHO, and SO₂ vertical column densities (VCDs; expressed in 10¹⁵ molec/cm²) and measurements of the same quantities by the Ozone Monitoring Instrument (OMI) at the Xianghe station in China. Linear regressions are shown in red and the black dashed curves correspond to the 1 to 1 line. The lower right panel displays a similar scatter plot between MAXDOAS aerosol optical depths (AODs) and measurements from a collocated CIMEL sunphotometer instrument belonging to the AERONET network.

BIOGENIC VOLATILE ORGANIC COMPOUNDS

Crist Amelynck and Niels Schoon

Importance of Biogenic Volatile Organic Compound Emissions for Atmospheric Chemistry

Terrestrial ecosystems such as forests, crops and grasslands are a considerable primary source of Biogenic Volatile Organic Compounds (BVOCs) with an estimated global emission rate of 1.2 petagram (Pg) of carbon per year (1 Pg = 10^{15} grams = one billion metric tonnes), which is more than ten times larger than the anthropogenic VOC source. Why BVOCs are emitted by plants is still a matter of debate, but there is evidence that they are used by plants to interact and communicate with their environment, for instance by repelling herbivores and pathogens or by attracting pollinators and natural enemies of infesting herbivores or parasites. Moreover, BVOC emissions are thought to mediate plant-plant communication and to protect plants against various kinds of environmental stresses.

The variety of VOCs emitted by plants is overwhelming and they are emitted by all plant tissues (leaves, stem, and roots). Isoprene and monoterpenes are dominating the global BVOC emission spectrum, and they are mainly emitted by broadleaf and coniferous trees, respectively. Another important class of BVOCs are small-chain oxygenated compounds (e.g. methanol, acetone, and acetaldehyde) which are emitted by all ecosystems, and which dominate emissions from crops and grasslands. Exposure of plants to stress induces the emission of some very specific compounds such as sesquiterpenes and green leaf volatiles, the latter ones being associated to the typical odour of freshly mown grass.

Because of their high global emission rate and generally strong atmospheric reactivity, BVOCs significantly influence the composition and physical properties of the atmosphere. BVOC oxidation has a major impact on air quality and health through formation of tropospheric ozone (in polluted regions) and secondary organic aerosols (SOA) and indirectly affects climate by increasing the atmospheric lifetime of methane. Moreover, SOA particles can alter cloud properties and, hence, influence climate.

In order to incorporate BVOC emissions in local, regional and global climate and transport models, considerable efforts have been made in the last two decades to set up species-specific BVOC emission inventories, based on landscape maps, climate data, biomass density data and BVOC-specific emission algorithms. Current algorithms only consider the effect of instantaneous and previous light and temperature conditions, soil moisture and leaf age on BVOC emissions. Recent research, however, has shown that many more factors, such as plant phenology, nutrient supply and all kinds of abiotic and biotic stresses, can significantly affect BVOC

emissions as well. More BVOC measurements are definitely required to improve existing emission algorithms accordingly.

BVOC Research Requires a Multidisciplinary Approach

The mass spectrometry group at BIRA-IASB started BVOC flux measurements in 2007, using a Proton Transfer Reaction Mass Spectrometer (PTR-MS). As BVOC research requires a highly multidisciplinary approach, strong collaborations were set-up with research groups at Ghent University and Liège University (Gembloux Agro-Bio Tech), encompassing the fields of atmospheric chemistry, analytical chemistry, ecophysiology, plant biology and micrometeorology.

First measurements were performed in the framework of the Belspo/“Science for a Sustainable Development” project IMPECVOC “Impact of environmental conditions and phenology on BVOC emissions from forest ecosystems” (2006-2011) and the FWO project “Measurement and modelling of BVOC emissions by forest in Flanders” (2006-2010). BVOC measurements were carried out at different plant organizational levels, from leaf/branch level (using dynamic enclosures) to the level of an entire ecosystem (using the Eddy Covariance technique).

Dynamic Branch Enclosure BVOC Exchange Measurements under Controlled and Natural Conditions

In contrast to natural environmental conditions, light intensity and temperature in an environmental chamber can be varied independently, allowing to disentangle the effects of both parameters on BVOC emissions. Flux measurements in the environmental chamber were carried out by enclosing branches of young tree species in inert dynamic enclosure systems. Upscaling of BVOC emissions from tree saplings to mature trees in forests is not straightforward and therefore branch enclosure measurements at different locations in the canopy of a mature beech tree were subsequently carried out.

The collected data allowed characterization of BVOC emissions from different tree species widespread over Europe. Temperature and light were found to be the major driving parameters, but clear evidence was found that a whole series of other parameters drive BVOC emissions as well. For example, an induced drought stress experiment and episodes of naturally occurring herbivore infestation reflected important changes in the emitted BVOC spectrum and in emission rates. Experiments on beech trees showed a stronger dependence of light-dependent monoterpene emissions on past temperature conditions than previously thought and they also revealed that BVOC emissions are strongly influenced by leaf phenology and position of the branch within the canopy.



Micrometeorological measurement station and shelter, housing the Proton Transfer Reaction Mass Spectrometer and peripheral equipment, for Eddy Covariance turbulent flux measurements at a corn field at Loncée, Belgium.

Proton Transfer Reaction Mass Spectrometer
an instrument in which trace gas molecules become charged upon transfer of a proton (H^+) from a protonated water molecule and are subsequently filtered according to mass-to-charge ratio and detected.

Phenology
the study of periodic plant cycle events (e.g. budbreak, flowering, maturation) and how these are influenced by seasonal and interannual variations in climate.

Eddy Covariance Technique
a technique to calculate vertical turbulent trace gas fluxes from simultaneous high-frequency three-dimensional wind speed and trace gas concentration measurements at a fixed point in space (e.g. above a forest canopy).



Tower for Eddy Covariance turbulent flux measurements at a mixed forest site at Vielsalm, Belgium.

Long-term Eddy Covariance BVOC Flux Measurements from Entire Ecosystems

The ecosystem-scale long-term Eddy Covariance turbulent flux measurements at the mixed forest at Vielsalm are quite unique in their kind. Only a few other data sets on ecosystem scale with comparable length, quality and completeness are available and therefore those data are very useful for evaluation of global carbon-chemistry-climate models. Deep statistical analysis of this database revealed some interesting features such as the influence of diffuse radiation on BVOC emissions compared to direct radiation. Analysis also showed that de novo synthesized isoprene is more efficiently produced in the top of the canopy than within the canopy. Deposition fluxes of oxygenated VOCs (e.g. methanol, acetaldehyde) are clearly observed for this mixed forest. On an annual basis, the forest even acts as a sink for methanol, which has never been reported in the literature up to now. An adsorption/desorption model of oxygenated VOCs in/from water films in the ecosystem, accompanied by chemical or biological degradation of these compounds in the water films, has been developed by the Unit of Biosystem Physics of the University of Liège and has been successfully applied for the modelling of the observed methanol deposition fluxes.

Future BVOC research, in the framework of the recently started FRFC project CROSTVOC “Impact of stress on Biogenic Volatile Organic Compounds exchange between crops and the atmosphere” (2013-2017), will focus on filling knowledge gaps in BVOC emissions from grasslands and crop ecosystems and on studying the impact of stress, related to future climatic conditions, on BVOC emissions by those ecosystems.

Selected References

Demarcke, M., J.-F. Müller, N. Schoon, H. Van Langenhove, J. Dewulf, E. Joó, K. Steppe, M. Šimpraga, B. Heinesch, M. Aubinet and C. Amelynck (2010), History effect of light and temperature on monoterpenoid emissions from *Fagus sylvatica* L., *Atmospheric Environment*, 44(27), 3261-3268, doi:10.1016/j.atmosenv.2010.05.054.

Laffineur, Q., M. Aubinet, N. Schoon, C. Amelynck, J.-F. Müller, J. Dewulf, H. Van Langenhove, K. Steppe and B. Heinesch (2012), Abiotic and biotic control of methanol exchanges in a temperate mixed forest, *Atmospheric Chemistry and Physics*, 12(1), 577-590, doi:10.5194/acp-12-577-2012.

Unger, N., K. Harper, Y. Zheng, N. Y. Kiang, I. Aleinov, A. Arneth, G. Schurgers, C. Amelynck, A. Goldstein, A. Guenther, B. Heinesch, C. N. Hewitt, T. Karl, Q. Laffineur, B. Langford, K. A. McKinney, P. Misztal, M. Potosnak, J. Rinne, S. Pressley, N. Schoon and D. Serça (2013), Photosynthesis-dependent isoprene emission from leaf to planet in a global carbon-chemistry-climate model, *Atmospheric Chemistry and Physics*, 13(20), 10243-10269, doi:10.5194/acp-13-10243-2013.

SATELLITE VALIDATION

Jean-Christopher Lambert

Why Satellite Data Require Validation

Spectrometric instruments in orbit offer a unique view on the global distribution of atmospheric constituents like ozone, pollutants and greenhouse gases. Primarily, these instruments measure the radiance emitted or reflected by the atmosphere and the Earth's surface. Using dedicated retrieval algorithms, the vertical column and/or profile of the target constituents is derived from their spectral signature identified in the measured radiance. However, the accuracy of the geophysical data retrieved from satellite measurements is known to be affected by a variety of sources of uncertainty, which need to be understood and characterized properly before any scientific use. Indeed, these uncertainties introduce not only systematic biases and random noise in the geophysical data, but they can also superimpose long-term drifts, fictitious geographical patterns and artificial cycles onto the real atmospheric trends, patterns and cycles of interest, making the latter less quantifiable, if not even undetectable in the worst cases.

Calibration and Validation

The characterization of a measurement system starts with the definition of the responses of this system to known, controlled signal inputs: this process is referred to as *calibration*. The radiometric and spectral responses of the instrument must be characterized appropriately to enable quantitative and unambiguous detection of atmospheric constituents through their effects on the measured radiance. Such calibration activities of the instrument are necessary not only before launch in a dedicated laboratory, but also continuously in orbit, since the performance of optical instruments and their associated detectors and electronics degrade severely with time, due to the harsh space environment. Unavoidable shorter-term changes in the properties of optical elements and detectors add to the longer-term degradation to introduce at a later stage, if not corrected properly, time-dependent drifts and artificial cycles in the atmospheric data time series.

After successful calibration of the radiometric data (radiance and irradiance spectra), the vertical column and/or profile of the target atmospheric species is retrieved through a suite of algorithms modelling the radiative transfer through the atmosphere and performing spectrometric analysis of the effects of the target atmospheric species on the measured spectra. This retrieval process is sensitive to uncertainties in the spectral analysis and the radiative transfer model, e.g. linked to errors on laboratory absorption cross-sections, a priori assumptions in the composition of the atmosphere and properties of the Earth's surface. In particular, uncertainties linked to features exhibiting a cyclic variation (e.g., solar elevation changing with time, diurnal and seasonal change in the vertical distribution of temperature, seasonal occurrence of snow...) can result in systematic errors with a periodic signal. Clouds and aerosols can modify the radiation field dramatically, and the determination of their coverage and properties is critical. For all these reasons and others it is essential to carry out the next step of data characterization, referred to as geophysical *validation*, which is defined as the process of assessing, by independent means, the quality and fitness-for-purpose of the geophysical data products derived from the measured spectra.

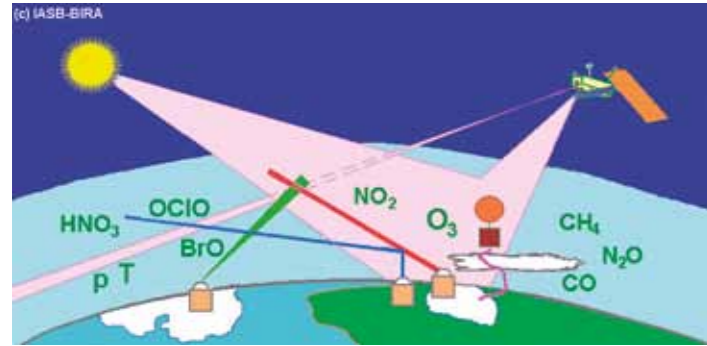

Principle of satellite validation: satellite measurements (here by SCIAMACHY and MIPAS on board ENVISAT) are confronted to reference correlative measurements acquired by certified ground- and balloon-based instruments.

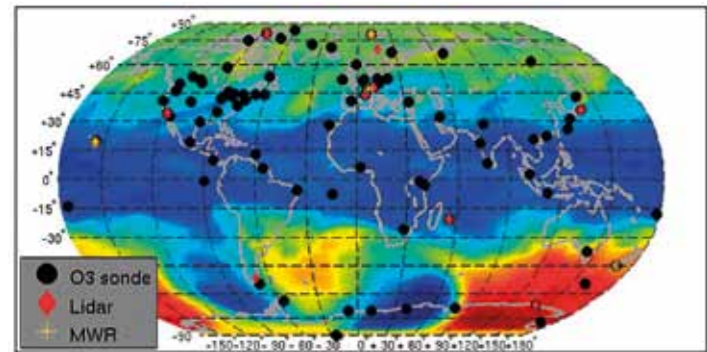

Geographical distribution of three networks contributing ozone profile reference measurements to satellite validation. The networks are superimposed on the mean ozone field of September 2002, with the unexpected split of the Antarctic ozone hole, demonstrating the need for sustained operation of well distributed networks.

The Essential Role of Ground-based Networks in Satellite Validation

Three cardinal principles rule the necessary quality assessment of any data, and *a fortiori* the necessary geophysical validation of atmospheric data from satellites. First, all data and derived products must have associated with them fully traceable indicators of their quality. Second, a Quality Indicator (QI) must provide sufficient information to allow all users to readily evaluate the “fitness for purpose” of the data and derived product. Third, a QI must be based on a documented and quantifiable assessment demonstrating the level of traceability to internationally agreed (where possible SI) reference standards.

Practically, calibration usually relies on several complementary methods, including regular measurements of reference radiation sources like onboard calibration lamps, the Sun and other stars, and vicarious calibration sites on Earth (e.g., homogeneous scenes offered by salt lakes and ice caps). The following step, geophysical validation, generally relies on comparisons with correlative measurements of the target constituents acquired by well characterised and documented instruments. Comparisons show how accurately the satellite data set reproduces known atmospheric signals measured by the reference systems: mean values, geographical patterns, short-term fluctuations, annual cycles, long-term trends, ...

To test the satellite data in as many conditions as possible, geophysical validation is carried out most preferably across a network of stations spanning different atmospheric states, latitudes, solar elevations, meteorological conditions, surface properties etc. The NDACC network is precisely a network of remote sounding stations shaped as a reference network for satellite validation. NDACC data respond to the cardinal requirements for reference data in satellite validation: quality and traceability of the NDACC data is ensured through their archival in a central database and through a suite of protocols ruling the design of NDACC instruments, their measurement and retrieval process, and their data quality control. The use of complementary instrumentation (e.g. spectrometers working in different spectral ranges, hence measuring similar constituents but with different sensitivities) enables investigations over the whole vertical range and of many species. The geographical distribution of the network makes it well suited to test satellites under a variety of atmospheric and climatic states of interest. Long-term quality commitments of the network enable the detection of subtle drifts and, importantly, the standard transfer needed between instruments operating on different satellites and during different periods. NDACC works under the auspices of WMO’s Global Atmosphere Watch, which includes other contributing networks with similar quality commitments like e.g. the Global Ozone Observing System (GO3OS), the Total Carbon Column Observing Network (TCCON) and the GCOS Reference Upper Air Network (GRUAN).

30 Years of Leading Research in Validation and Metrology of Remote Sensing

In the 1980s, BIRA-IASB initiated a long and unique record of satellite validation activities by conducting balloon-based measurements of the vertical profile of stratospheric ozone and nitrogen dioxide. Already with the geophysical validation of first generation satellites, the metrology of data comparisons was questioned: in the observed discrepancies between satellite- and balloon-based data, how to discriminate between real discrepancies and the effects of spatial mismatch and, in the case of nitrogen dioxide, of diurnal cycle effects?

In the mid-1990s, with the advent of ESA’s ERS-2 GOME, the first of a series of European instruments dedicated to the global monitoring of atmospheric gases from space, BIRA-IASB started a long-lasting pioneering support to the validation and evolution of the new generation of satellites, by means of reference measurements acquired by NDACC, other networks and other satellites. One example is the evolution of GOME total ozone data: in 15 years of sustained effort, the GOME data have progressed from the simple, inaccurate detection of stratospheric ozone ($\pm 20\%$ of bias depending largely on the solar elevation), to a reprocessed data record meeting the extremely stringent requirements for climate research and for IPCC studies: less than 1% of bias, whatever the solar elevation, and a long-term stability better than 1%/decade. Validation methods have progressed in parallel to the evolution of scientific requirements for satellite data, with in-depth research in the metrology of remote sensing and of atmospheric data comparisons. To date, BIRA-IASB has developed accurate validation methods for ozone and many pollutants and greenhouse gases, with publication of formal validation protocols and a long list of research articles. It has participated in the validation and evolution of data from two dozen satellites operated by ESA, EUMETSAT, NASA, the Canadian Space Agency etc. Building on this heritage, BIRA-IASB is now preparing the validation of the next generation satellites, including the European Copernicus Sentinels and the future geostationary constellation of air quality satellites.

Selected References

- Lambert, J.-C., M. Van Roozendaal, M. De Mazière, P. C. Simon, J.-P. Pommereau, F. Goutail, A. Sarkissian and J. F. Gleason (1999), Investigation of pole-to-pole performances of spaceborne atmospheric chemistry sensors with the NDSC, *Journal of the Atmospheric Sciences*, 56(2), 176-193, doi:10.1175/1520-0469(1999)056<0176:IOPTPP>2.0.CO;2.
- Lambert, J.-C., A. Piters, A. Richter, S. Mieruch, H. Bovensmann, M. Buchwitz and A. Friker (2011), Validation, in *SCIAMACHY: exploring the changing Earth’s atmosphere*, edited by Gottwald, M. and H. Bovensmann, pp. 147-173, Springer, Dordrecht.
- Lambert, J.-C., C. De Clercq and T. von Clarmann (2013), Combining and Merging Water Vapour Observations: A Multi-dimensional Perspective on Smoothing and Sampling Issues, in *Monitoring Atmospheric Water Vapour: Ground-Based Remote Sensing and In-situ Methods*, edited by Kämpfer, N., pp. 215-242, Springer, New York.
- Piters, A. J. M., K. Bramstedt, J.-C. Lambert and B. Kirchhoff (2006), Overview of SCIAMACHY validation: 2002-2004, *Atmospheric Chemistry and Physics*, 6(1), 127-148, doi:10.5194/acp-6-127-2006.
- Piters, A. J. M., B. Buchmann, D. Brunner, R. C. Cohen, J.-C. Lambert, G. de Leeuw, P. Stammes, M. van Weele and F. Wittrock (2011), Data Quality and Validation of Satellite Measurements of Tropospheric Composition, in *The Remote Sensing of Tropospheric Composition from Space*, edited by Burrows, J.P., U. Platt and P. Borrell, pp. 315-364, Springer, Heidelberg.
- Richter, A., M. Weber, J. P. Burrows, J.-C. Lambert and A. van Gijssel (2013), Validation Strategy for Satellite Observations of Tropospheric Reactive Gases, *Annals of Geophysics*, 56, doi:10.4401/ag-6335.

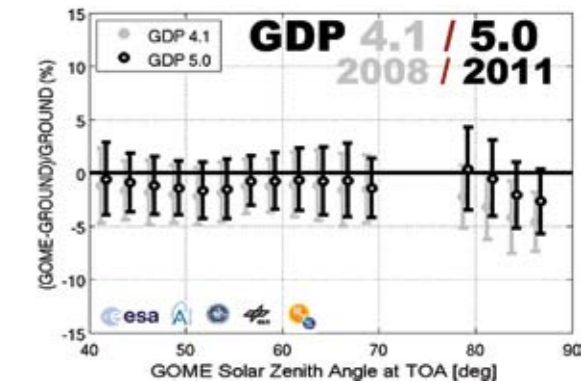
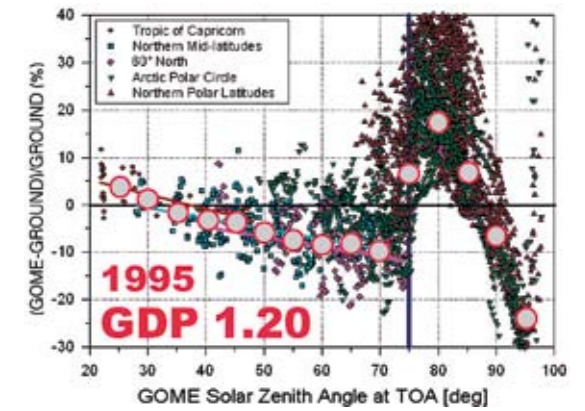

Evolution of the GOME ozone column data quality with respect to NDACC reference network data, as a function of the solar zenith angle of the satellite measurement. Seven versions of the GOME Data Processor (GDP) have been developed from 1995 (6 months after its launch) to 2011. After 15 years of continuous research, the latest version meets the climate research requirements of systematic bias less than 1% at all solar angles, and stability better than 1% per decade. This figure presents the developmental version GDP 1.20 and the last operational version GDP 5.0. TOA means Top of the Atmosphere.

THE BELGIAN RADIO METEOR STATIONS NETWORK

Hervé Lamy

Earth's atmosphere is constantly hit by interplanetary solid particles whose size varies between a fraction of a micron and a few meters. The latter objects are very rare but a recent remarkable example is the Chelyabinsk fireball observed above Russia in February 2013. The cumulated mass of these particles entering the atmosphere every day is estimated between 40 and 100 tons. They move at supersonic speeds (over 11.2 km/s) and are strongly heated when they hit atoms and molecules of the upper atmosphere. Most of them are fully vaporized at heights between 80 and 120 km. Along their trajectory, these particles also create a trail of electrons which can reflect a Very High Frequency radio wave (frequency f between 30 and 300 MHz) emitted by a transmitter on the ground. The duration of this reflection can last from a fraction of a second for the smallest objects up to several minutes for the very big ones. This is the basic principle of the radio detection of meteors used by the Belgian RAdio Meteor Stations (BRAMS), a project of the Belgian Institute for Space Aeronomy funded by the Solar-Terrestrial Center of Excellence (STCE). BRAMS comprises a dedicated transmitter located on the site of the "Centre de Géophysique du Globe" in Dourbes and a set of more than 25 radio receiving stations spread over the Belgian territory.

Reflection of the radio waves mostly comes from one point of the trail of electrons and its position changes depending on the location of the receiver (the reflection is said to be specular). Multi-station observations can therefore be used to reconstruct the initial trajectory of the meteor, which is one of the main goals of the BRAMS project. Once the trajectory is known, a detailed analysis of the signal received at each station provides additional information on the object such as ionization, speed, deceleration and mass. These observations also give access indirectly to speed of winds or mesospheric temperatures at altitudes which are too low for in-situ measurements by spacecraft or too high to be reached by balloons. The second main goal of the BRAMS project is to compute meteor fluxes which are very important for example to estimate the risks of impact for spacecraft in orbits.

The two main advantages of radio observations of meteors over optical observations are a higher sensitivity to small objects (which are the more numerous and do not give rise to a detectable luminosity) and the possibility to carry out observations continuously (while optical observations can only be performed during night time and with clear skies).

So far, BIRA-IASB has finalised the installation of more than 25 radio receiving stations synchronized by GPS receivers. Most stations are hosted by public observatories or by radio amateurs. Since the observations are

carried out continuously, each station provides approximately 1 GB of data per day. These data are first stored locally then regularly sent to BIRA-IASB where they are analysed and archived. Access to the BRAMS data is possible via the BRAMS website.

The first step in processing the raw data is to make a spectral analysis of the signal which generates a spectrogram. The majority of meteors have a typical spectral signature which in principle allows an easy identification in these spectrograms. This task is however complicated by the presence of parasitic signals such as reflections on airplanes, local interferences or sometimes strong broadband radio emissions due to solar flares. A lot of efforts is currently put in the development of a method for automatic detection of meteor echoes in spectrograms.

The BRAMS network is operational and, for some stations, data have been recorded for several years. One of the stations located on the radio-astronomical site of Humain (belonging to the Royal Observatory of Belgium) will be a radio interferometer allowing to determine the direction of arrival of the meteor echoes with an accuracy of about 1° . This will greatly facilitate the reconstruction of trajectories for those meteors giving rise to an echo in Humain. In the coming months, most efforts will concentrate on developing powerful algorithms for trajectory reconstruction and meteor flux computations.

Selected References

Calders, S. and H. Lamy (2012), BRAMS: status of the network and preliminary results, Proceedings of the International Meteor Conference, Sibiu, Romania, 15-18 September 2011, 73-76.

Calders, S., C. Verbeeck, H. Lamy, S. Ranvier and E. Gamby (2013), Results of Draconid 2011 observations from the BRAMS network, Proceedings of the International Meteor Conference, La Palma, Canary Islands, Spain, 20-23 September 2012, 84-87.

Calders, S., H. Lamy, E. Gamby and S. Ranvier (2014), Recent developments in the BRAMS project, Proceedings of the International Meteor Conference, Poznan, Poland, 22-25 August 2013, Manuscript submitted for publication.

Lamy, H., S. Ranvier, J. De Keyser, S. Calders, E. Gamby and C. Verbeeck (2011), BRAMS: the Belgian RAdio Meteor Stations, in Meteoroids: The Smallest Solar System Bodies, Proceedings of the Meteoroids Conference, Breckenridge, Colorado, USA, May 24-28 2010, NASA/CP-2011-216469, edited by Cooke, W. J., D. E. Moser, B. F. Hardin and D. Janches, pp. 351-356.

Lamy, H., E. Gamby, S. Ranvier, Y. Geunes, S. Calders and J. De Keyser (2013), The BRAMS viewer: an online-tool to access the BRAMS data, Proceedings of the International Meteor Conference, La Palma, Canary Islands, Spain, 20-23 September 2012, 48-50.

Ranvier, S., M. Anciaux, H. Lamy, J. De Keyser, S. Calders and E. Gamby (2013), Radio polarization measurement of meteor trail echoes during the 2012 Perseids, Proceedings of the International Meteor Conference, La Palma, Canary Islands, Spain, 20-23 September 2012, 51-56.

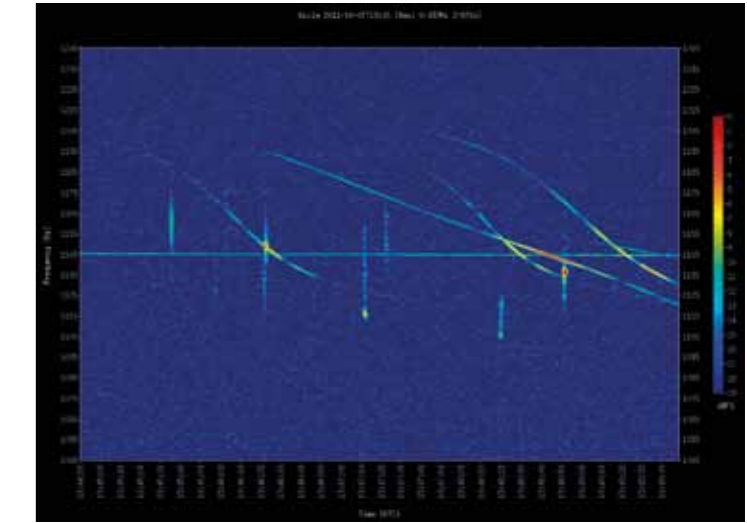

Spectrogram obtained at the receiving station in Uccle on 07/10/2011 at 13h45 UT. Each spectrogram has a duration of 5 minutes. The frequency band shown is centred on the transmitter frequency (horizontal signal at 1145 Hz) and is 200 Hz wide. Signals due to meteors are those which appear essentially vertical and are therefore short-lived, while long-lasting spectral signatures (several minutes) are due to reflections on planes.



Shooting stars observed by balloon on November 1867. (Etching from Cicéri in Glaisher, J., E. Ciceri, C. Flammarion, W. de Fonmelle, A. Marie, A. Tissandier, and G. Tissandier (1870), Voyages aériens, pp. 342-343, L. Hachette et Cie, Paris).



Top: Transmitter located in Dourbes (a crossed dipole with a 8m x 8m metallic grid acting as a reflecting plan).
Left: Receiving antenna located in Uccle (3-elements Yagi antenna).



Website

<http://brams.aeronomie.be>

MAPPING AIR QUALITY FROM AN UNMANNED AERIAL VEHICLE

Alexis Merlaud and Michel Van Roozendaal

With contributions from Caroline Fayt, Jeroen Maes, Frederik Tack

Building on the expertise of BIRA-IASB in ground-based and airborne spectroscopic techniques for atmospheric research, a new activity has recently been initiated in the institute, which aims to operate compact custom-made instruments dedicated to study air quality from Unmanned Aerial Vehicles (UAVs).

Interest of UAV Platforms for Atmospheric Research

UAVs are increasingly being used in atmospheric research. Their most obvious interest lies in performing experiments in hazardous environments such as inside typhoons, volcanic plumes, or merely close to the ground. Thanks to the progress in the miniaturization of instrumentation, UAVs also offer low-cost alternatives for various airborne experiments currently performed from balloons or traditional aircraft, such as measuring profiles of temperature and relative humidity in the atmospheric boundary layer. Besides reducing the total cost of these experiments, an advantage of operating from UAVs is the ease of deployment of such small platforms, which require only minimal infrastructures compared to traditional aircraft.

The UAV Activity at BIRA

In this context, BIRA-IASB has initiated a UAV activity in one of its fields of expertise: the measurement of atmospheric trace gases using the so-called DOAS technique (see also Section "NDACC"). Target chemical species are key components in air quality such as nitrogen dioxide (NO_2), sulfur dioxide (SO_2), and ozone (O_3). Particulate matter can also be quantified from a UAV with the same technique. DOAS instruments have already been operated from aircraft for satellite validation, urban air quality studies or for investigating the exhaust plumes of individual ships or volcanoes. Our aim is to reproduce all these experiments from a UAV. A longer term objective is the improvement of the high resolution chemical transport models, which is not possible with space-based sensors due to the limited spatial resolution of the latter.

Instrumental Challenges

Compared to operating an instrument from the ground or from a traditional aircraft, a miniaturization effort is required when working with a UAV. Reaching the limited size, weight, and power consumption was possible through the use of compact spectrometers and computers, together with custom-built electronics circuits and housings. We chose the whiskbroom set-up, which is widely used for space-based instruments (LANDSAT, IASI, GOME-2). Simulations indicate that, when flying at 3 km altitude, we should be able to produce maps of

Trace Gas

Any gas in the Earth's atmosphere except its two major constituents: nitrogen (N_2) and oxygen (O_2). In dry air, trace gases make up less than 1% of the atmosphere's volume. Despite their small amounts, trace gases have major impacts on the physical and chemical properties of the Earth system. For instance, ozone shields the solar UV and the greenhouse effect is controlled by the concentration of some trace gases (CO_2 , water vapor, methane, ...). Air quality is determined by the abundance of other trace gases (NO_x , SO_2 , ...) and particulate matters.

Atmospheric Boundary Layer

The part of the atmosphere directly above the surface, in which both most humans live and most pollutants are emitted. The height of this boundary layer varies between 100m and 3km.

Whiskbroom Set-up

A technique of producing images consisting in collecting the light reflected by a mirror scanning across the flight direction. A single detector is thus needed to produce images of the ground.

NO_2 in the atmospheric boundary layer at a ground resolution of 200 m, covering an area of $20 \times 20 \text{ km}^2$ in 1 hour. Such characteristics are especially promising for validation studies of air quality satellites, whose pixel sizes are currently around $10 \times 10 \text{ km}^2$.

The SWING Instrument

The Small Whiskbroom Imager for Atmospheric composition monitorinG (SWING) is the UAV payload built at BIRA-IASB. This instrument is based on previous BIRA-IASB mobile DOAS experiments and was developed in the framework of a collaboration with the University of Galati, Romania, which built in parallel the UAV platform. SWING is based on a compact grating spectrometer, a miniature computer, and a scanning mirror. The weight, size and power consumption of SWING are respectively 920 g, $27 \times 12 \times 12 \text{ cm}^3$, and 6 W. The housing was manufactured using the 3D printing technology. The UAV is an electrically propelled flying-wing, whose wingspan is 2.5 m. It can fly at 3 km altitude for 90 minutes.

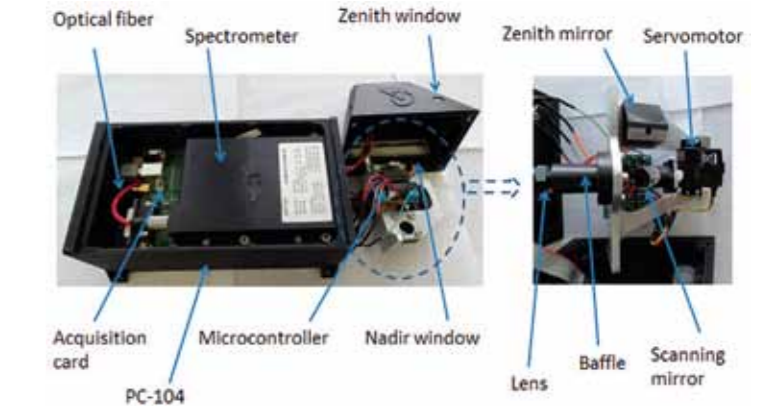

The SWING payload, a miniature trace gas imager dedicated to measurements from a UAV.

The UAV platform before takeoff in front of a thermal power station in Romania.

Status and Future Experiments

So far, SWING has been tested from an ultralight aircraft in Belgium in 2012 and from the UAV in Romania in May and September 2013. One of the UAV experiments was performed downwind of the city of Galati, across the Danube River. Galati is a middle size city (250 000 inhabitants) but includes the largest steel factory in Romania. This urban area is thus expected to be a large NO₂ source, as was confirmed by previous car-based DOAS measurements. NO₂ and water vapor were clearly detected in the UAV spectra of the flight on 20 September 2013.

The UAV activity is ongoing. At the time of writing, we are developing the georeferencing algorithms necessary to produce air quality maps. We are also working on a second version of the SWING-UAV system with our Romanian colleagues, which will be able to measure SO₂ and aerosols in addition to NO₂ and water vapor. In the near future, we will perform more flights around large power plants or chemical factories in Romania and compare the measurements with other airborne and ground-based instruments dedicated to air quality in the context of a dedicated international field campaign. The SWING-UAV observation system is also scheduled to take part in another field campaigns for ship emissions monitoring around La Réunion Island, where BIRA-IASB already operates several ground-based instruments (see NDACC section). In a more remote future, SWING-UAV could be used to study the air quality at the level of individual streets in Belgian cities.

Selected References

Constantin, D.-E., A. Merlaud, M. Van Roozendaal, M. Voiculescu, C. Fayt, F. Hendrick, G. Pinardi and L. Georgescu (2013), Measurements of Tropospheric NO₂ in Romania Using a Zenith-Sky Mobile DOAS System and Comparisons with Satellite Observations, *Sensors* 13, 3922-3940, doi:10.3390/s130303922.

Merlaud, A. (2013), Development and use of compact instruments for tropospheric investigations based on optical spectroscopy from mobile platforms, Presses universitaires de Louvain, Louvain-la-Neuve, Belgium.

Merlaud, A., D. Constantin, C. Fayt, J. Maes, F. Mingireanu, I. Mocanu, M. Voiculescu, G. Murariu, L. Georgescu and M. Van Roozendaal (2013), Small Whiskbroom Imager For Atmospheric Composition Monitoring (SWING) From An Unmanned Aerial Vehicle (UAV), in Proceedings of the 21st ESA Symposium on European Rocket and Balloon Programmes and Related Research, 9-13 June 2013, Thun, Switzerland, edited by Ouwehand, L., ESA SP-721, pp. 233-240, ESA Publications Division, Noordwijk, The Netherlands.

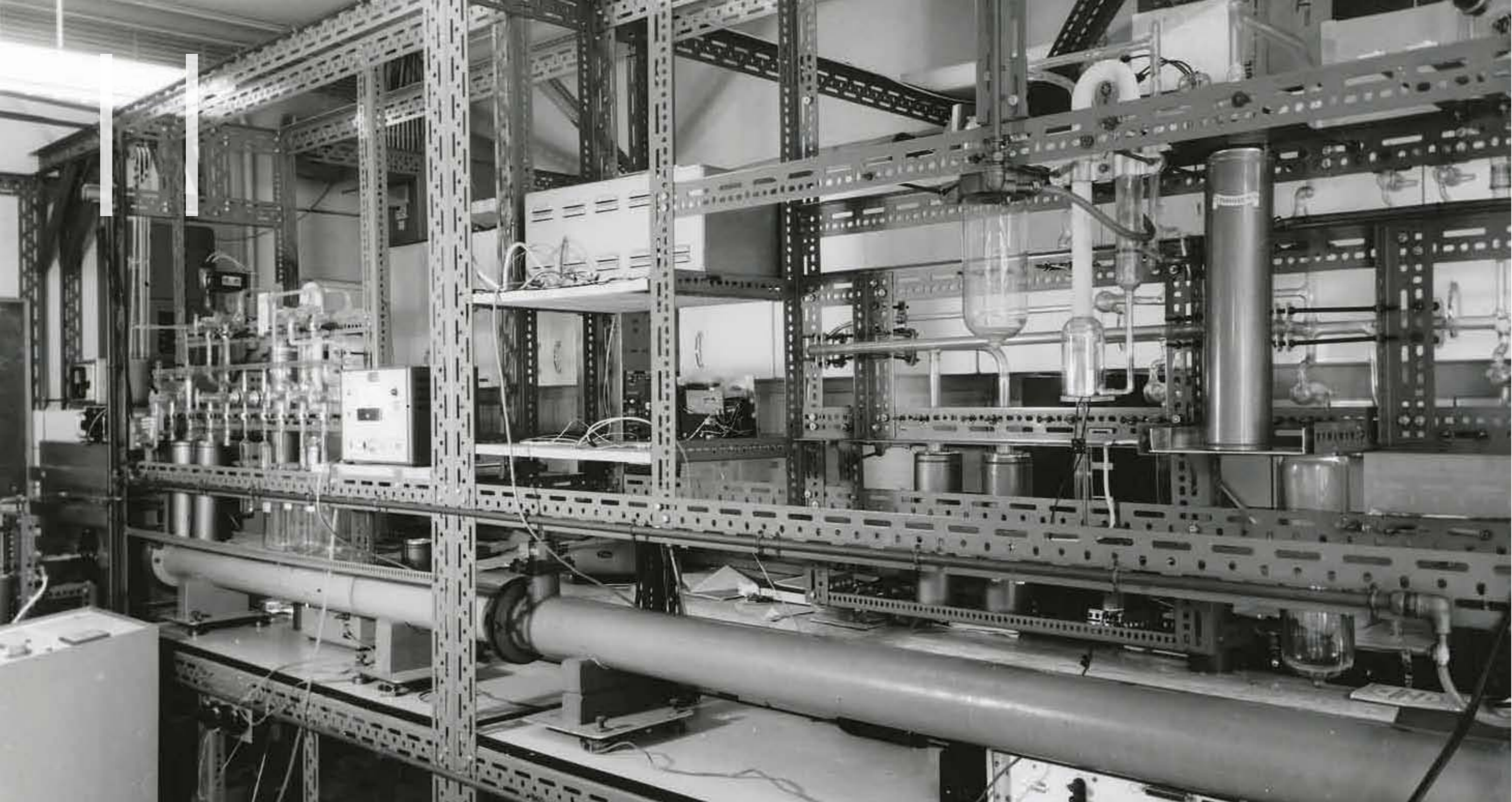

BELGISCH INSTITUUT VOOR RUIMTE-AÉRONOMIE (BIRA) INSTITUUT D'AÉRONOMIE SPATIALE DE BELGIQUE (IASB) BELGIAN INSTITUTE FOR SPACE AERONOMY (BIRA-IASB) BELGIECH INSTITUUT VOOR RUIMTE-AÉRONOMIE (BIRA) INSTITUUT D'AÉRONOMIE SPATIALE DE BELGIQUE (IASB)

LABORATORY STUDIES

Ann Carine Vandaele and Crist Amelynck



Ann Carine Vandaele and Crist Amelynck

Experimental set-up for absorption cross-section measurements in the sixties.

The climate evolution of the last decades has created the need to monitor the changes of the atmospheric composition. The discovery of the ozone hole over Antarctica and of a similar phenomenon in the Arctic, the global warming of the atmosphere through the increasing emissions of man-made greenhouse gases, and the analysis of the effects of volcanic activities on a global scale, are but some examples of issues addressing the political and the public communities. The global observation of trace gases is presently best performed from space-borne instruments, and certainly observations of other planets' atmospheres rely on such instrumentation. Most of these space- or ground-based measurements use spectroscopic instruments that probe regions of the electromagnetic spectrum extending from the microwave to the ultraviolet. The retrieval of abundances from the spectra require validated inversion algorithms, but most importantly strongly depend on the availability of accurate reference spectra or data, which can only be acquired in the laboratory under well-defined and controlled conditions. The knowledge of the radiative properties of the atmospheric species is also valuable for the modelling of the radiative transfer of the atmosphere, be it of Earth or of other planets.

The interest for spectroscopy applied to atmospheric studies has a very long history at the Belgian Institute for Space Aeronomy. Indeed even our first director, Marcel Nicolet, started his scientific career with the study of star spectra. The first spectroscopic studies carried out at the institute date from the sixties and were devoted to the measurement of the absorption of molecular oxygen (O_2) in the Schumann-Runge bands (175-205 nm). Since then the laboratory was upgraded throughout the years and different species were investigated, such as HNO_3 and chloro-fluoro-methanes. Fourier Transform (FT) spectrometers have recently superseded conventional grating spectrometers for the measurement of spectroscopic data, even in the UV-visible region.

Another aspect developed at BIRA-IASB concerns the study of gas phase ion/molecule reactions in support of the *in situ* detection of atmospheric trace gases by Chemical Ionization Mass Spectrometry (CIMS). It started with the development of novel reaction schemes for the detection of stratospheric trace gases in the framework of the Measurement of Atmospheric Constituents by Selective Ion Mass Spectrometry (MACSIMS) project (see chapter 6) and is ongoing today with laboratory studies aiming at selective detection of biogenic volatile organic compounds (BVOCs).

The following sections will give an overview of the main achievements related to laboratory measurements performed at BIRA-IASB.

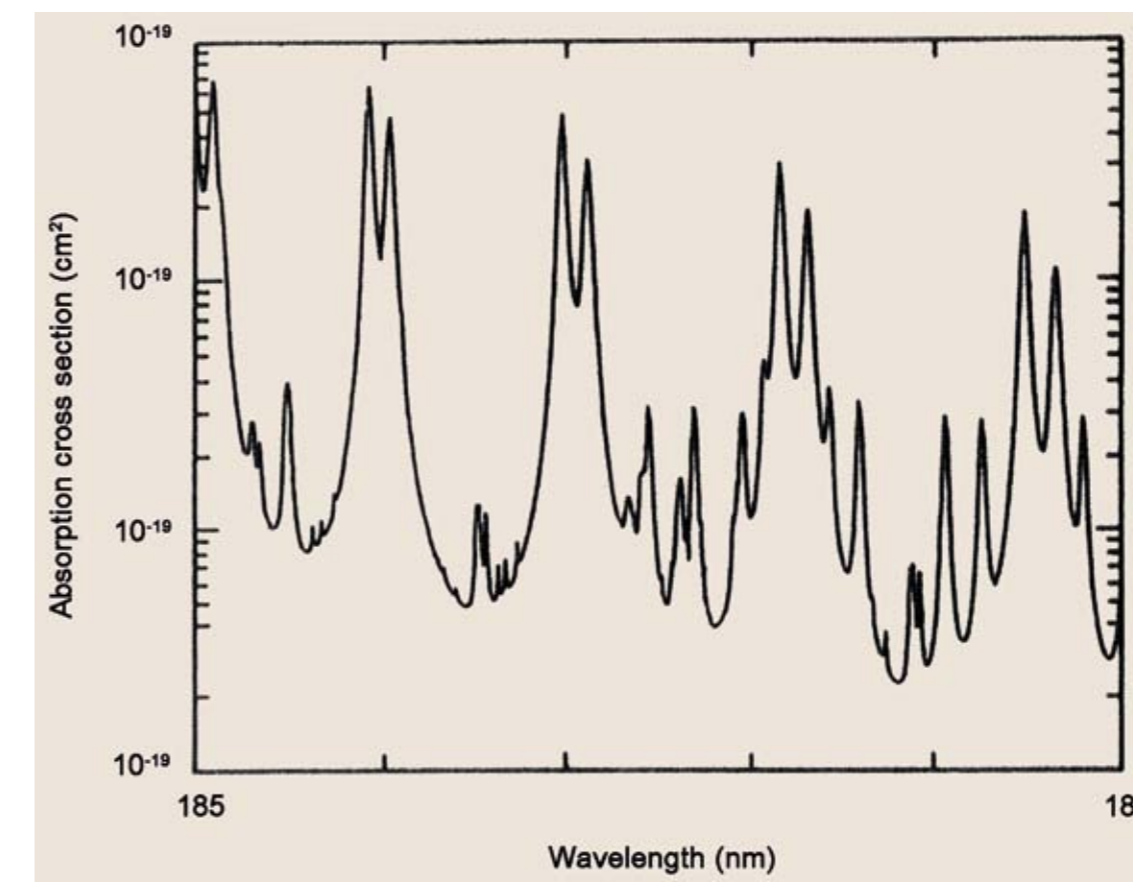

Details of the O_2 Schumann-Runge absorption bands between 185-186 nm.

MOLECULAR OXYGEN ABSORPTION CROSS SECTION BETWEEN 175 AND 205 NM

Paul C. Simon

The characteristics of the ultraviolet absorption spectrum of O₂ are important in aeronomy because photodissociation of O₂ by solar ultraviolet radiation between 175 and 242 nm is the source of ozone in the mesosphere and, to a lesser extent, in the stratosphere. Moreover, the O₂ absorption controls almost completely the penetration of this solar ultraviolet into the atmosphere.

The absorption cross section varies by about five orders of magnitude in that wavelength range and photodissociation calculation requires accurate and detailed measurements. Experimental results have been obtained by Ackerman and Biaumé at high resolution at specific wavelengths. These accurate measurements were used by Kockarts to calculate very high resolution absorption cross section corresponding to the width of O₂ lines in that range. BIRA-IASB made at that time a major contribution in photodissociation process studies in the mesosphere and the upper stratosphere. This work has been refined later by Nicolet and Peetermans (1980).

Selected References

Ackerman, M., F. Biaumé and G. Kockarts (1970), Absorption cross sections of the Schumann-Runge bands of molecular oxygen, *Planetary and Space Science*, 18(11), 1639-1651, doi:10.1016/0032-0633(70)90038-3.

Biaumé, F. (1973), Nitric acid vapour absorption cross-section spectrum and its photodissociation in the stratosphere, *Journal of Photochemistry*, 2(2), 139-149, doi:10.1016/0047-2670(73)80012-7.

Nicolet, M and W. Peetermans (1980), Atmospheric absorption in the O₂ Schumann-Runge band spectral range and photodissociation rates in the stratosphere and mesosphere, *Planetary and Space Science*, 28(1), 85-103, doi:10.1016/0032-0633(80)90106-3.

Nicolet, M. and R. Kennes (1988), Aeronomic problems of molecular oxygen photodissociation - III. Solar spectral irradiances in the region of the O₂ Herzberg continuum, Schumann-Runge bands and continuum, *Planetary and Space Science*, 36(10), 1059-1068, doi:10.1016/0032-0633(88)90043-8.

Nicolet, M. and R. Kennes (1988), Aeronomic problems of molecular oxygen photodissociation - IV. The various parameters for the Herzberg continuum, *Planetary and Space Science*, 36(10), 1069-1076, doi:10.1016/0032-0633(88)90044-X.

Nicolet, M., S. Cleslik and R. Kennes (1988), Aeronomic problems of molecular oxygen photodissociation - II. Theoretical absorption cross-sections of the Schumann-Runge bands at 79 K, *Planetary and Space Science*, 36(10), 1039-1058, doi:10.1016/0032-0633(88)90042-6.

The **absorption cross section** of a species is the ability (probability) of this molecule to absorb a photon of a particular wavelength. Here we are most interested in the ultraviolet spectral range because of its effect on the photochemistry of planetary atmospheres, in particular that of Earth.

HALOCARBONS ABSORPTION CROSS SECTIONS

Didier Gillotay and Paul C. Simon

As mentioned in chapter 9, the ozone loss processes in the stratosphere by chlorine radicals was first suggested in 1974. Halocarbons are photodissociated in the upper stratosphere by the solar UV radiation of wavelengths around 200 nm, generating chlorine and bromine radicals.

Modelling of aeronomic processes, and in particular of the chemistry of stratospheric ozone, requires therefore the accurate knowledge of the interaction of these minor atmospheric constituents with the incoming ultraviolet solar radiation. This is particularly true for compounds like chloro-fluoro-carbons (CFCs), alternative CFCs and brominated compounds (Halon).

The interaction matter-radiation is experimentally accessible by measuring the absorption cross sections of these molecules in the laboratory, which rely on the measurement of the amount of light absorbed by a sample at a given wavelength. Spectrophotometry, particularly in the visible and UV spectral ranges of the electromagnetic spectrum, is one of the most widely used techniques in chemistry and the life sciences. Excited molecules can possess any one of a set of discrete quanta of energy described by the laws of quantum mechanics defining the energy levels of the molecule. The energy (and wavelength) of absorption is defined by the difference between the energy levels of the transition. In UV-visible spectrophotometry, the observed transitions occur between different electronic energy levels, and are influenced to a lesser extent by vibrational energy levels, which arise from the various modes of vibration of the molecule (e.g. the stretching and bending of various covalent bonds). In general, electronic transitions consist of a cluster of closely spaced spectral lines, so close one to the other that they cannot be distinguished. We then speak of absorption cross-section.

By comparing the incident and transmitted intensity of the radiation passing through a cell containing the sample to analyse, it is possible to derive the absorption cross section of the species of interest. Indeed the absorption of light is proportional to the absorption cross section, to the concentration of the species in the cell and to the length of the cell. Accurate measurements of absorption cross-sections therefore require high accuracy measurements of temperature and pressure, i.e. the concentration of the species. High accuracy is also needed on the measurement of the length of the optical path (i.e. of the cell in which the absorber is placed). And of course, the best possible determination of the incident and transmitted flux intensities is requested.

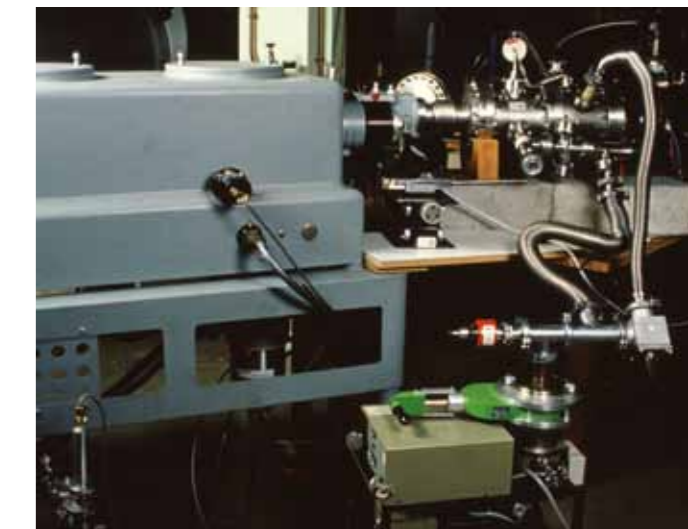

Experimental set-up for halocarbon cross-section measurement.

The absorption cross sections were measured, after purification of the gases through vacuum distillation, by scanning the entire spectrum (160-320 nm), wavelength after wavelength. This was done using a double beam monochromator equipped with two absorption cells of respectively 200 cm and 20 cm length. One cell is used as reference and the other one as absorption cell. For each wavelength, incident and absorbed flux intensities are measured quasi simultaneously by means of two separate detectors. It is very important that both cells are maintained exactly at the same temperature.

This type of experimental device allows to measure the UV absorption cross-sections at a wide range of temperatures (from 210 to 295 K) covering the different conditions met in the stratosphere. UV absorption cross sections of more than thirty CFC, HCFC and halons were measured at the BIRA-IASB as a function of temperature during the seventies and eighties and are still currently used as basic input data in many stratospheric models.

In addition to ultraviolet spectroscopic studies, infrared cross sections of substitutes for halocarbons currently used in the nineties have been obtained at very high resolution using the ULB Fourier transform spectrometer at three temperatures, namely 287 K, 270 K, and 253 K. These alternative hydrohalocarbons have similar physical properties but have lower ozone depletion potential as CFCs because of their low atmospheric lifetime due to their reactivity with the hydroxyl (OH) radical acting like the "cleaning" agent of the troposphere. Unfortunately, their potential contribution to the radiative forcing of the atmosphere was not negligible and required accurate measurements of absorption cross section made at the ULB and two-dimensional radiative-chemical-dynamical modes calculations made at NCAR to determine their global warming potential. The results obtained in this study were useful in the definition of future regulations on halocarbons.

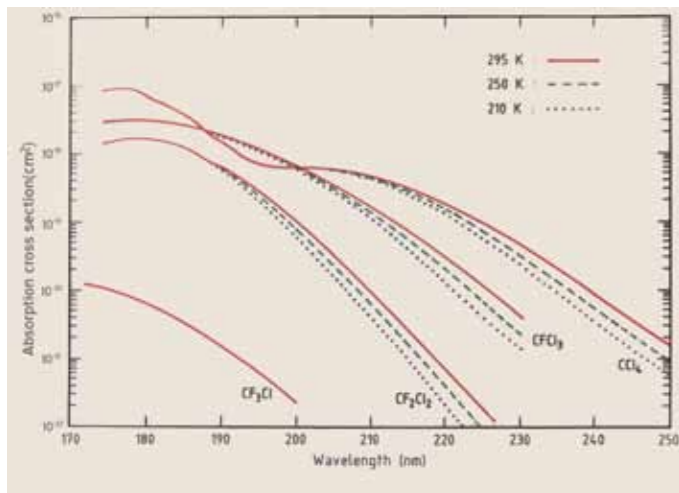

Absorption cross-sections of some CFCs at three stratospheric temperatures.

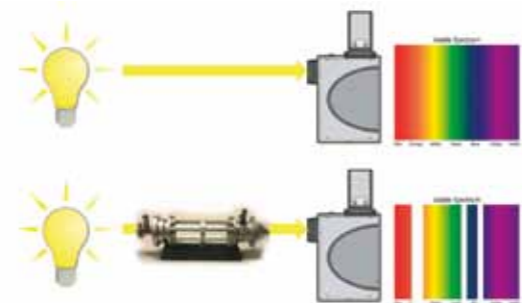

Measurement principle of the absorption cross-section based on the Beer-Lambert law.

Selected References

Clerbaux C., R. Colin, P.C. Simon and C. Granier (1993), Infrared Cross Sections and Global Warming Potentials of 10 Alternative Hydrocarbons, *Journal of Geophysical Research: Atmospheres*, 98(D6), 10491-10497, doi:10.1029/93JD00390.

Gillotay, D. and P.C. Simon (1988), Ultraviolet Absorption Cross-Sections of Methyl Bromide at Stratospheric Temperatures, *Annales Geophysicae*, 6(2), 211-215.

Gillotay D. and P.C. Simon (1989), Ultraviolet absorption spectrum of trifluoro-bromo-methane, difluoro-dibromo-methane and difluoro-bromo-chloro-methane in the vapor phase, *Journal of Atmospheric Chemistry*, 8(1), 41-62, doi:10.1007/BF00053815.

Gillotay, D. and P.C. Simon (1991), Temperature dependence of ultraviolet absorption cross-sections of alternative chlorofluoroethanes, *Journal of Atmospheric Chemistry*, 12(3), 269-285, doi:10.1007/BF00048076.

Gillotay, D. and P.C. Simon (1991), Temperature-dependence of ultraviolet absorption cross-sections of alternative chlorofluoroethanes: 2. The 2-chloro-1,1,1,2-tetrafluoro ethane -HCFC-124, *Journal of Atmospheric Chemistry*, 13(3), 289-299, doi:10.1007/BF00058136.

Gillotay, D., A. Jenouvrier, B. Coquart, M. F. Merienne and P.C. Simon (1989), Ultraviolet absorption cross-sections of bromoform in the temperature range 295-240K, *Planetary and Space Science*, 37(9), 1127-1140, doi:10.1016/0032-0633(89)90084-6.

Gillotay D., P.C. Simon and G. Brasseur (1989), Absorption cross-sections of alternative chlorofluoroethanes and potential effects on the ozone layer, *Planetary and Space Science*, 37(1), 105-108, doi:10.1016/0032-0633(89)90073-1.

Simon, P.C., D. Gillotay, N. Vanlaethem-Meuré and J. Wisemberg (1988), Ultraviolet Absorption Cross-Sections of Chloro- and Chlorofluoro-Methanes at Stratospheric Temperatures, *Journal of Atmospheric Chemistry*, 7(2), 107-135, doi:10.1007/BF00048042.

Simon, P.C., D. Gillotay, N. Vanlaethem-Meuré and J. Wisemberg (1988), Temperature dependence of Absorption Cross-Sections of Chlorofluoro-Ethanes, *Annales Geophysicae*, 6(2), 239-248.

ATMOSPHERIC TRACE CONSTITUENTS

Ann Carine Vandaele and Christian Hermans

Scientists at BIRA-IASB, in close collaboration with the Laboratoire de Chimie Physique Moléculaire of the Université Libre de Bruxelles (CPM, now Service de Chimie Quantique et Photophysique) and the Université Champagne-Reims in France, performed a series of laboratory measurements of different molecules absorbing in the UV-visible and near-IR ranges: SO_2 , NO_2 , $\text{O}_2/\text{O}_2\text{-O}_2$, H_2O and its isotopologues HDO and D_2O . The measurement principle is the same as the one described in the previous section: it requires the measurement of the radiation attenuation through a cell filled by the sample in its gas form.

In general, temperature and pressure dependent cross sections are needed for atmospheric studies. Indeed, large temperature effects are expected and observed. They are due to the changes in the thermal populations of the vibrational and rotational levels, as the temperature changes. As both effects are important in atmospheric studies, references obtained in the laboratory should be measured under temperature and pressure conditions as close as possible to the atmospheric ones. This means in general operating at very low pressures of the molecule under investigation and with a buffer gas at pressures up to 1013 hPa for Earth and for planets like Mars or Venus with CO_2 as buffer gas, since CO_2 is the main element of these atmospheres. The low pressures imply the use of very long absorption paths to ensure a good accuracy on the cross sections. Such long paths are generally obtained through the use of multiple reflection cells. The larger one was 50 m long and was located in one of the famous caves of Reims. More recently, SO_2 and BTX (benzene, toluene, and xylene) absorption cross sections were obtained at high resolution. Most of these data are now part of worldwide renowned spectroscopic databases, such as HITRAN or GEISA.

Fourier transform spectrometers have superseded conventional grating spectrometers for the measurement of spectroscopic data, even in the UV-visible region. These instruments provide a very high-resolution and wave number-calibrated data. The advantages of the Fourier transform spectrometers are numerous and explain why such instruments have been used in the laboratory as well as in the field to determine line parameters or monitor atmospheric pollutants, from the ground or even from space (ACE-FTS for the Earth, PFS on board Mars Express). Until recently, these instruments were essentially operated in the IR region. In UV and visible regions, the absorption features are generally large or even diffuse, the spectra are often congested and it is not possible to separate individual absorption lines, hence the absorption cross section concept. However some molecules (O_2 or H_2O for example) have spectra, in which individual lines are still present and observable up to the UV. Classical FT spectroscopy can therefore be extended in these spectral regions to deliver line parameters, such as the line positions, the intensities, and the self and foreign gas broadening coefficients.

Recently BIRA-IASB initiated a new collaboration with the Laboratoire Lasers et Spectroscopies group of the University of Namur in view of the preparation of the future ExoMars mission to be launched in 2016 (see chapter 13). One of the main objectives of this mission is to disprove or confirm the presence of methane (CH_4) on Mars. Improved reference laboratory data are therefore needed. The observation of methane will be done in the IR spectral domain, where each transition line is seen independently, contrary to the UV domain. Specific instrumentation is required, especially if one looks for the change of the line profile when CO_2 , the main constituent of the Martian atmosphere, is present. Using a tunable diode-laser spectrometer, we have measured the CO_2 -broadening coefficients of 28 absorption lines of CH_4 . Each line was recorded at room temperature and at different pressures, ranging from 8 to 50 hPa, which allowed for the determination of the effect of CO_2 on CH_4 .

Laboratory measurements of high quality as support to space missions will always be a prerequisite to any improvement of the observations and detection possibilities. This is true for the next mission to Mars, but it will also be true in future, when the limits of the current instrumentation will be surpassed by new techniques and technology.

Selected References

Fally, S., M. Carleer and A.C. Vandaele (2009), UV Fourier transform absorption cross sections of benzene, toluene, meta-, ortho-, and para-xylene, *Journal of Quantitative Spectroscopy and Radiative Transfer*, 110(9-10), 766-782, doi:10.1016/j.jqsrt.2008.11.014.

Hermans, C., A.C. Vandaele and S. Fally, Fourier transform measurements of SO_2 absorption cross sections: I. Temperature dependence in the 24 000-29 000 cm^{-1} (345-420 nm) region (2009), *Journal of Quantitative Spectroscopy and Radiative Transfer*, 110(9-10), 756-765, doi:10.1016/j.jqsrt.2009.01.031.

Vandaele, A.C., P.C. Simon, J.M. Guilmet, M. Carleer and R. Colin (1994), SO_2 absorption cross section measurement in the UV using a Fourier transform spectrometer, *Journal of Geophysical Research: Atmospheres*, 99(D12), 25599-25605, doi:10.1029/94JD02187.

Vandaele, A. C., M. de Maziere, C. Hermans, M. Carleer, C. Clerbaux, P.F. Coheur, R. Colin, S. Fally, B. Coquart, A. Jenouvrier and M.-F. Merienne (2003), UV-Visible and near-IR spectroscopy of atmospheric species, in *Recent research developments in chemical physics*, Vol.4, Pt. I., edited by Pandalai, S.G., pp. 325-344, Transworld Research Network, Trivandrum, India.



Experimental set-up of cross-sections measurements in basement of the University of Reims.

CHEMICAL IONIZATION STUDIES OF ATMOSPHERIC COMPOUNDS

Crist Amelynck and Niels Schoon

Quadrupole Mass Spectrometer

An arrangement in which ions with a desired mass-to-charge ratio are made to describe a stable path under the effect of a static and a high-frequency electric quadrupole field, and are then detected. Ions with a different mass/charge are separated from the detected ions because of their unstable paths.

VOCs and BVOCs

Volatile organic compounds (VOCs) are organic chemicals that have a high vapor pressure at ordinary room temperature. VOCs are numerous, varied, and ubiquitous. They include both human-made and naturally occurring chemical compounds. Most scents are of VOCs. VOCs play an important role in communication between plants, and messages from plants to animals. Some VOCs are dangerous to human health or cause harm to the environment. BVOCs are biogenic VOCs such as those emitted by the vegetation. Typical classes of BVOCs which have been studied in the laboratory are monoterpenes (C₁₀H₁₆ compounds) and sesquiterpenes (C₁₅H₂₄).

Isobaric Compounds

Compounds having the same nominal mass, but not necessarily the same elemental composition

Isomeric Compounds

Compounds having the same elemental composition but a different chemical structure

Laboratory ion chemistry studies at BIRA-IASB started with the development of a Flowing Afterglow instrument (FA), consisting of a flow tube reactor coupled to a quadrupole mass spectrometer. Negative reactant ions were produced upstream of the reactor and convectively transported by an inert buffer gas flow to the mass spectrometer sampling orifice at the downstream end of the flow tube. Rate constants of ion/molecule reactions could be determined by introducing controlled flows of the neutral reactant at a fixed distance upstream of the sampling orifice and by simultaneously monitoring the corresponding decrease of the reactant ion signal with the mass spectrometer. Identification of the resulting product ions allowed elucidation of the reaction mechanisms. Rate constants and product ion distributions of ion/molecule reactions were generally obtained at room temperature and at a pressure of around 1 hPa. The laboratory instrument was mainly used to study ion/molecule reactions of several reactant ion species (e.g. CO₃⁻, Cl_n⁻ (n=1-3), CF₃O⁻) with stratospherically relevant trace gases (e.g. HNO₃, ClONO₂, HCl) in support of the detection and quantification of these trace gases by means of the balloon-borne MACSIMS instrument. Because of the low temperatures and high pressures in the lower stratosphere, hydration of the reactant ions in the reactor of the flight instrument was very efficient and ion/molecule reactions of water clusters of the reactant ions were additionally studied for accurate quantification of the stratospheric compounds.

To improve inherent shortcomings of FA instruments, a *Selected Ion Flow Tube* instrument (SIFT) was built at BIRA-IASB. In a SIFT instrument, the reactant ions are sampled from the ion source into a vacuum chamber, mass-selected by a quadrupole mass filter and subsequently injected into the flow tube reactor. Injection of a single reactant ion species into the reactor allows to study ion/molecule reactions in better defined conditions and enables accurate determination of the mass discrimination of the instrument.

Gas Phase Ion Chemistry Studies of Biogenic Volatile Organic Compounds

Whereas the Flowing Afterglow (FA) experiments mainly focused on negative ion chemistry of trace gases of stratospheric interest, the SIFT instrument has mainly been used to study the reactions of BVOCs with H₃O⁺, NO⁺ and O₂⁺. The interest of studying BVOC ion chemistry in support of these techniques stems from the importance of these compounds for tropospheric chemistry and their impact on air quality and climate (see Section 10.5 on BVOC field measurements).

The SIFT experiments at BIRA-IASB started with the kinetic and mechanistic study of monoterpene isomers and some of their atmospheric oxidation products with the three reactant ions, monoterpenes being a major class of BVOCs which are now regularly being measured worldwide. This pilot study was followed by ion chemistry studies of other relevant classes of VOCs such as biogenic alcohols (green leaf volatiles a.o.),

sesquiterpenes, biogenic alcohols and aldehydes and esters of biogenic and anthropogenic origin. These SIFT studies showed some typical reaction mechanisms for the reactions of the three reactant ion species with specific BVOC classes and provided a wealth of data which are directly applicable to the detection of these compounds.

Towards More Selective On-line BVOC Detection

Many isomers have been detected in the atmosphere for the different classes of BVOCs. However, apart from a few selected examples, the three available reactant ions in commercial CIMS instrumentation cannot be used for selective isomer detection or for selective detection of compounds which result mainly in isobaric product ions (e.g. monoterpenes and the monoterpene alcohol linalool). In order to increase the selectivity in BVOC detection without losing the on-line capability, several novel approaches were recently started in the laboratory. A first approach consists in adapting the SIFT instrument to a Flowing Afterglow - Selected Ion Flow Tube instrument (FA-SIFT), to allow the production of other reactant ions than H₃O⁺, NO⁺ or O₂⁺, which might lead to more selective BVOC detection.

A second approach consists in replacing the quadrupole mass spectrometer by a tandem mass spectrometer. In this instrument major product ions of the reactant ion/BVOC reaction are sampled into a vacuum chamber, mass-selected in a first quadrupole filter and subjected to collision-induced fragmentation in an octopole collision cell. The resulting fragment ions are subsequently analyzed by a second quadrupole analyzer. The applicability of the method depends on whether isomeric product ions lead to different, species-dependent, fragmentation patterns. This method has allowed to distinguish some monoterpene isomers and some sesquiterpene isomers, which can be considered as a step forward towards selective detection of those compounds.

Since chemical ionization mass spectrometry has been used in many recent important discoveries related to atmospheric trace gas and particle composition and continuously gains in importance, proper characterization of the underlying gas phase ion/molecule reactions in dedicated SIFT-related laboratory studies will remain important in the future.

Selected References

Amelynck, C., N. Schoon and F. Dhooghe (2013), SIFT Ion Chemistry Studies Underpinning the Measurement of Volatile Organic Compound Emissions by Vegetation, *Current Analytical Chemistry*, 9(4), 540-549, doi:10.2174/15734110113099990018.

Dhooghe, F., C. Amelynck, J. Rimetz-Planchon, N. Schoon and F. Vanhaecke (2009), Flowing afterglow selected ion flow tube (FA-SIFT) study of ion/molecule reactions in support of the detection of biogenic alcohols by medium-pressure chemical ionization mass spectrometry techniques, *International Journal of Mass Spectrometry*, 285(1-2), 31-41, doi:10.1016/j.ijms.2009.04.001.

Rimetz-Planchon, J., F. Dhooghe, N. Schoon, F. Vanhaecke and C. Amelynck (2011), MS/MS studies on the selective on-line detection of sesquiterpenes using a Flowing Afterglow-Tandem Mass Spectrometer (FA-TMS), *Atmospheric Measurement Techniques*, 4(4), 669-681, doi:10.5194/amt-4-669-2011.



The Selected Ion Flow Tube laboratory instrument at BIRA-IASB.

12



BELEGCH INSTITUUT VOOR RUIMTE-AERONOMIE (BIRA) INSTITUUT D'AERONOMIE SPATIALE DE BELGIQUE (IASB) BELGIAN INSTITUTE FOR SPACE AERONOMY (BIRA-IASB) BELGIECH INSTITUUT VOOR RUIMTE-AERONOMIE (BIRA) INSTITUUT D'AERONOMIE SPATIALE DE BELGIQUE (IASB)

AEROSOLS

Christine Bingen



The glowing atmosphere at sunset. Picture taken around 35 km altitude from a stratospheric balloon.

Christine Bingen

The term “aerosols” is a general name referring to solid or liquid particles in suspension in the atmosphere. The optical properties of aerosols have an impact on the radiative balance of the atmosphere through absorption and scattering of solar radiation. The vertical distribution of aerosols plays a non-negligible role in the vertical distribution of solar energy in the atmosphere (and therefore controls its thermal structure), but also in the formation of clouds.

Contrarily to molecules that have a well-defined chemical structure and properties that can be quantified in the laboratory, aerosols present a great variability in terms of size, shape, and composition that can possibly evolve during the whole time of their existence. Their origin can be very diverse, either natural (sea salts, desert dust, volcanic clouds and ashes, etc.) or anthropogenic (emissions from agricultural activities, biomass burning, urban or industrial pollution, etc.). In the stratosphere, aerosols originate mainly from huge volcanic eruptions able to send sulfuric gases and ashes to such high altitudes. They consist then basically of small liquid droplets composed of water and sulfuric acid, with a diameter of about 0.01 to 0.05 micron and may freeze and give rise to polar stratospheric clouds at very low temperatures encountered during the polar night (about -78°C). It is important to know their characteristics (composition, size) to determine the way they perturb light propagation through the atmosphere by scattering or absorption (combined in the concept of aerosol extinction), and how they influence the stratospheric physico-chemistry.

Remote sensing of atmospheric aerosols can be made through occultation observations, based upon the observation of a light source (usually the Sun, but possibly other stars or planets) through the atmosphere and the measure of the extinction caused by species contained along the line of sight. Compared to limb or nadir observations of reflected sunlight, occultation only depends on scattered light by atmospheric species in the

forward direction. Important information (shape, size, composition ...) on aerosols can be obtained by sampling the scattering phase functions at the limb, from balloon.

BIRA-IASB is closely associated with the history of aerosol research, where it took a pioneering role at several key moments, sometimes by lack of interest from larger research teams for a topic they considered as minor. From the early studies of the aerosol layer discovered in the stratosphere by Junge in 1960 and observed from stratospheric balloons to the last developments of tropospheric aerosol research triggered by the air pollution issue, BIRA-IASB has played an important role in the development of aerosol research through the achievement of observation campaigns, modelling and development of retrieval techniques for the satellite data processing. The present chapter gives an overview of the main milestones of this Belgian advance through aerosol science.



Photographs of the Earth limb taken at low solar elevation angles from balloon gondolas on 7 May and on 5 June 1980. In the 5 June case, material from the Mount St Helens volcano has spread in the low stratosphere over a large horizontal extent. It enhances the brightness of the limb so that the cloud cover in the foreground can hardly be seen through the whitish veil. In contrast, the cloud cover is well visible on 7 May. (from: Nature magazine, 16 October 1980)

AEROSOL BALLOON FLIGHTS

Christian Muller and Christine Bingen

Phase Function

Function describing the variation of the scattered light as a function of the viewing direction. The phase function also depends on the considered wavelength characterizing the light colour.

Extinction

Combined effect of the scattering and the absorption undergone by a light ray during its propagation.

Azimuth angle: Angle formed by two vertical planes including respectively the Sun-observer direction, and the observer viewing direction.

BALLAD

BALloon Limb Aerosol Detection scanned the Earth's limb at three wavelengths (450, 600, and 850 nm) at sunset, from an altitude of 30-35 km. Polarization is also measured in the 850 nm channel.

Radiative Transfer

Theoretical method used to describe the light propagation through a scattering medium, possibly with a complex configuration.

Research at the young Belgian Institute for Space Aeronomy mainly focused on the upper atmosphere, ionic and neutral chemistry. Aerosol science was less in the scope of aeronomic research at the Institute, and neither the influence aerosols may have on atmospheric chemistry nor the importance of their interaction with the atmosphere and solar radiation, were as clear as today.

When Everything Changed: the Start of Concorde Flights

In 1976 started the commercial exploitation of the Concorde. In contrast to usual commercial airplanes, which fly at an altitude of about 11 km, this supersonic airplane was able to fly in the lower stratosphere at altitudes of 16 to 18 km. Anticipating the development of a fleet of about 150 Concorde aircrafts and 350 larger supersonic aircrafts in America, scientists were concerned about the fact that the emissions produced by these new engines, flying through the stratosphere, might produce a new artificial aerosol layer sufficient to initiate a new cold period. The emission of stratospheric planes as well as the black carbon particles produced from their exhaust became a research topic from the point of view of radiative transfer. At that time, aerosol scattered light was even seen by eye by passengers during high altitude supersonic flights.

Earlier, in the 1930s, observations at the Pic du Midi had already revealed the presence of coloured circles presupposing the existence of elevated atmospheric layers, and evidence of enhanced scattering in the red and of absorption in the blue wavelength range indicated the probable existence of metallic nuclei at high altitude.

The Era of Balloon-borne Aerosol Measurements at BIRA-IASB

In the eighties, BIRA-IASB started to investigate the stratospheric aerosol layer. Stratospheric balloons, already used at the Institute at that time, formed an ideal platform for such studies. A new experiment is designed in which cameras loaded with argentic film are mounted on a rotating balloon gondola. Four cameras are aimed to the Earth limb: one loaded with colour film and the three others with panchromatic film and with filters in the near UV, blue and near infrared. The cameras are the same Hasselblad reflexes, which NASA had qualified for the Apollo programme, with the space qualified 80 mm Zeiss objective. The optical properties of these cameras are thus perfectly characterised. The experimental setup allowed measuring simultaneously the phase function (the intensity of radiation versus the observation angle) and the extinction of the setting Sun by the aerosols. Using some hypotheses, these two elements are sufficient to derive the overall aerosol size properties and density.

Subsequent balloon campaigns have flown with this setup, delivering beautiful pictures of the aerosol layer, a challenge in view of the experimental conditions. The cameras are controlled remotely from the ground by

a very simple device. Information about the altitude and azimuth angle is sent to the ground from sensors on board the gondola, which moves and rotates by the action of the local winds. Researchers controlling the experiment on the launch site disposed of a simple calculator (a latest fashion HP67 calculator for the last flights) to perform triangulation calculations in real time, and to decide from the incoming geolocation information when the camera had to be activated. Pointing the cameras at the right moment in the right direction to the Sun is an art, which delivered some very successful photographs thanks to the skills of the researchers on the ground.

Five balloon campaigns are carried out from Aire-sur-l'Adour (France) between 1980 and 1984 with an experimental setup dedicated to aerosol measurements. The results are surprising. During the first flight on 7 May 1980, the background aerosol layer, contrarily to what is believed at that time, is clearly measured.

On May 18th, the Mount St. Helens erupted in the North-Western US, about 8 500 km away from Aire-sur-l'Adour. On 5 June 1980, shortly after the beginning of this eruption, a second balloon flight was launched by BIRA-IASB from Aire-sur-l'Adour. Measurements revealed a huge strengthening of the aerosol layer, showing unambiguously that the Mount St. Helens cloud was able to migrate rapidly around the globe and to feed the aerosol layer. The link between the aerosol layer and Earth's volcanic activity was established. At the publication of this discovery in Nature, pictures taken on board the balloon illustrated the cover of the famous journal. This BIRA-IASB observation helped to understand the cooling effect of previous volcanic eruptions (Laki, Tambora, Krakatau, ...) and their impact on weather and climate.

A later balloon flight put into evidence a layer of "brown" particles (particularly absorbing in the blue) around the 64 km altitude. This layer is still not confirmed at present, but probably comes from metallic particles generated by the entry of meteorites into the atmosphere, on which chemical molecules are able to condensate.



Eruption of the Mount St. Helens in the North-Western US on 18 May 1980. (credit: United States Geologic Survey)



Balloon-borne aerosol measurements at Kiruna (Sweden) during the Arctic SESAME campaign in 1995. (courtesy: Florence Goutail)

Stratospheric Aerosols and the Ozone Depletion Issue

Although the interest for the satellite technology gradually took over the efforts devoted to aerosols through the “home-made” ORA experiment and the development of the ENVISAT programme, aerosol observations by balloons were pursued through a collaboration with the “Laboratoire d’Optique Atmosphérique” (LOA) from the “Université des Sciences et Technologies” in Lille (France).

In the framework of the EU-funded SESAME Arctic campaign in 1995, balloon flights were performed in Kiruna (Sweden). During this winter, the “BALloon Limb Aerosol Detection” (BALLAD) instrument developed at LOA was launched twice. BIRA-IASB participated to the analysis of the results (see chapter 9).

The aim of this campaign was to better understand the processes responsible for the ozone depletion in the polar stratosphere, giving rise to the so-called “ozone hole”. The link between stratospheric aerosols and polar stratospheric clouds on the one hand, and heterogeneous chemistry and the radiative budget of the stratosphere on the other hand had already been established. A better knowledge of the aerosol chemical composition and phase, and of aerosol size properties, was needed to characterize the catalytic chemical processes occurring at the surface of aerosols and leading to ozone destruction.

Overall, the balloon-borne observations of aerosols gave a clear impetus to aerosol studies at the Institute, and gradually, the team studying this kind of particles, expanded. An appreciated tradition of aerosol research at BIRA-IASB was born.

Selected References

Ackerman, M., C. Lippens and M. Lechevallier (1980), Volcanic material from Mount St Helens in the stratosphere over Europe, *Nature*, 287, 614-615, doi:10.1038/287614a0.

Ackerman, M., C. Lippens and C. Muller (1981), Stratospheric aerosols properties from Earth limb photography, *Nature*, 292, 587-591, doi:10.1038/292587a0.

Ackerman, M., C. Lippens, C. Muller and P.Vrignault (1982), Blue sunlight extinction and scattering by dust in the 60-km altitude atmospheric region, *Nature*, 299, 17-20, doi:10.1038/299017a0.

Ramon, D., C. Brogniez, P. Lecomte, J. Lenoble, C. Verwaerde, P.C. Simon and C. Muller (1995), Detection of aerosols from balloon limb observations, *SPIE Proceedings 2582, Atmospheric Sensing and Modeling II*, 100-109, doi:10.1117/12.228528.

STRATOSPHERIC SATELLITE OBSERVATIONS : OCCULTATION & IMAGING INSTRUMENTS

Filip Vanhellemont

With contributions from Charles Robert

Aerosol Observations Throughout History

The visual observation of atmospheric aerosols and clouds is probably as old as humanity itself: the optical extinction of solar light by liquid sea spray, mineral desert sand, biomass burning smoke, water clouds or ice cirrus is immediately obvious when observing sunsets and sunrises. Written testimonies on the visual observation of volcanic aerosols date back to at least Pliny the Younger, who reported on events during and following the Vesuvius eruption (of Pompeii fame) in AD 79. Stratospheric aerosols cause the effect of the “purple light”, reddening of the twilight sky when the Sun is 3 to 4 degrees below the horizon (18 to 24 minutes after sunset). The connection between the “purple light” and aerosol in the atmosphere at high altitudes was realized for the first time after the Krakatoa eruption in 1883, when a lot of volcanic ash and gases penetrated in the stratosphere (“The eruption of Krakatau, and subsequent phenomena”, report of the Krakatau committee of the Royal Society, 1888). William Ashcroft, contemporary English painter made many sketches of spectacular twilights after the eruption. The “purple light” was later observed after many major volcanic eruptions, which took place in 20th century. The “purple light” phenomenon was explained as a result of light scattering on stratospheric aerosol after the discovery of the stratospheric aerosol layer by Christian Junge in 1960. Rev. Sereno Edward Bishop, some time after the Krakatau eruption in 1883, published an early scientific observation at Honolulu of diffraction rings around the solar disk in the journal *Nature*. A direct causal link between all these optical phenomena and stratospheric aerosols was proven only in the 20th century with the aid of balloon experiments, but prior to this, observation of the Sun had always been the main observational modus.

Measuring Aerosol Abundance: the Occultation Method

Admiring a sunset or sunrise is essentially a way of performing a qualitative transmission measurement: solar light enters the atmosphere, is partly absorbed and scattered by the atmospheric species (gases, particles) and finally reaches the observer, who indirectly (remotely) infers knowledge on the state of the atmospheric species along the optical path. The combination of several subsequent transmission measurements while the Sun is setting or rising is known as a solar occultation experiment.

Such a ground-based observation of course provides only local atmospheric information, twice a day. The situation improves when we move the observing device on board a satellite. Several occultation measurements occur within 24 hours and the geographic coverage is much larger. We get a few additional bonuses:



Sketches by William Ascroft, showing the Krakatau afterglow as seen from London on the 26th of November 1883 at 4.30 p.m.

Occultation Measurement

Combination of several subsequent transmission measurements by observation of the sun or by any other light source, planet or star, through the atmosphere while it is setting or rising. If the light source is the Sun, one speaks about solar occultation; if it is a star, one speaks about stellar occultation.

Optical Extinction

the physical process of light attenuation through optical absorption and scattering by molecules and particles.

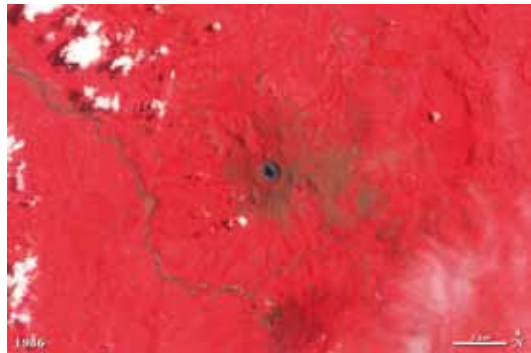

False-color image of El Chichón in Mexico seen in 1986 (above), four years after the eruption of March–April 1982. The new caldera, inside the older caldera, is prominent, along with the crater lake that formed shortly after the 1982 eruption. Almost thirty years later (below), the ash and volcanic debris are still noticeable in many of the drainages and the crater lake in the summit caldera. Red is vegetated areas, grey are ash/tephra deposits. (credit: NASA.)

an increased sensitivity due to the long optical paths, a better altitudinal resolution caused by the sideways observational geometry, and the absence of optical extinction by the dense tropospheric region. It is hardly a surprise then that the first global maps of high-altitude aerosols and clouds were provided by NASA's first-generation satellite-borne solar occultation experiments. From 1978 onward, a long-term stratospheric aerosol/cloud database has emerged, fed with data provided by instruments such as SAMII, and follow-ups SAGEI, II and III. Most importantly, for the first time in history the formation and global geographical spreading of the stratospheric aerosols resulting from plinian volcanic eruptions (especially El Chichón, Mexico, 1982, and Mount Pinatubo, the Philippines, 1991) could be monitored.

There is no reason for the exclusive use of solar light for occultation measurements; in principle, every light source will do. The idea of stellar occultation as a means to probe planetary atmospheres dates back at least one century, and the technique was successfully applied to determine the atmospheric properties of nearly all planets in our solar system (e.g. the Voyager missions).



Vast quantities of volcanic gases (mostly sulfur dioxide) were blown into the atmosphere during the eruption of Mount Pinatubo in 1991. The globally distributed aerosols were responsible for spectacular sunsets. (credit: The U.S. National Archives and Records Administration)



The Earth's limb at sunset before and after the Mt. Pinatubo eruption. Above: Image of a relatively clear atmosphere, taken August 30, 1984. Astronauts were looking at the profiles of high thunderstorms topping out at the tropopause at sunset. Below: the same type of photograph, taken August 8, 1991, less than two months after the Pinatubo eruption. Two dark layers of aerosols make distinct boundaries in the atmosphere.

BIRA-IASB Activities

Our Institute made its own contribution through the development of the Occultation Radiometer (ORA), consisting of a UV/Vis/Near-Infrared module, and an infrared part. Mounted on the European EURECA space platform, it was meant to be launched in 1988 on board a Space Shuttle. However, the 1984 Challenger disaster caused a major rescheduling of all Shuttle missions. In hindsight, this turned out to be somewhat of a lucky strike; by the time of the ORA launch (July 31, 1992), the stratosphere had been injected with a staggering 17 Megaton of SO₂ gas, produced by the 1991 Mount Pinatubo eruption, the most spectacular volcanic event in the 20th century in terms of stratospheric effects. The subsequent evolution of the stratospheric sulphate aerosols was followed beautifully by ORA during its 10-month operation, and the obtained data led to a number of important papers.

BIRA-IASB has been actively involved in the GOMOS science team for more than a decade. GOMOS (Global Ozone Monitoring by Occultation of Stars), a UV-visible grating spectrometer working in stellar occultation mode on board the European Earth-orbiting ENVISAT satellite, performed measurements during its entire 11-year mission from March 2002 to April 2012. Although mainly targeted towards ozone observation, GOMOS has delivered a good long-term view of the global distribution of stratospheric aerosols, PSCs and cirrus clouds, including the sporadic production of aerosols from volcanic eruptions (such as the Soufrière Hills eruption, Montserrat, 2006). At present, BIRA-IASB is finalizing a new retrieval code that will deliver improved profiles of aerosol optical extinction, particle concentration and size. The climatology, derived from these results, will be crucial for the modelling of the dynamics of stratospheric particles and their role in processes such as ozone depletion and radiative forcing.

Future Prospects

With respect to particle and cloud type identification, simple altitude profiles of aerosol optical extinction are of limited use; a complete 2D image of the observed scene would be more suitable. And indeed, in the past two decades, digital imaging detectors have permitted instruments such as the Canadian-Belgian instrument ACE (Atmospheric Chemistry Experiment) on the SCISAT-1 platform to be equipped with imaging channels (see section "ACE", chapter 8). At present, a full-blown multi-spectral satellite-imaging instrument (see section "ALTIUS", chapter 8) is being developed at BIRA-IASB, which will be launched in the coming years. Apart from atmospheric trace gas data, the images will deliver information on the abundance of aerosols/clouds and the morphology of the associated atmospheric layers. Needless to say, the prospect of such a technically innovating instrument, of BIRA-IASB design, is very exciting.

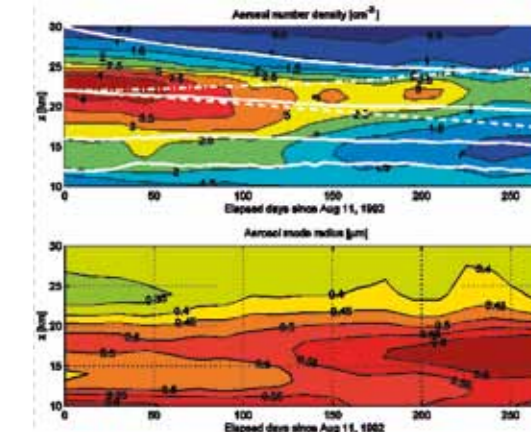

Mount Pinatubo stratospheric aerosol time evolution retrieved from ORA data. Top panel: latitude-averaged time evolution of aerosol number density. Full lines refer to modelled vertical trajectories starting at 12, 16, 22 and 30 km respectively. The dashed line is the $z = 22$ km trajectory, only accounting for sedimentation, while the dot-dashed line only includes vertical advection. Bottom panel: time evolution for the median particle size. Notice the anti-correlation between both plots: coagulation processes cause the gradual decrease of particle concentrations, and the associated growth of particles. (source: PhD thesis Filip Vanhellemont)

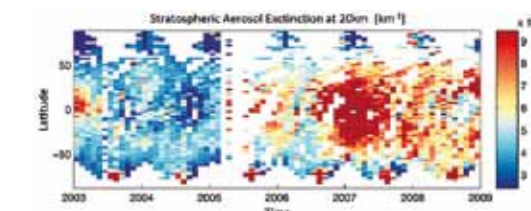

Zonally averaged stratospheric aerosol extinction evolution as observed by the GOMOS instrument between 2003 and 2009 at an altitude of 20 km. One can notice various increases in the aerosol extinction during that period which are mostly associated with volcanic eruptions such as Ruang (09/2002, 2°N), Reventador (11/2002, 0°N), Soufriere Hills (05/2006, 16°N), Tavurvur (10/2006, 4°S), Okmok (07/2008, 55°N) and Kasatochi (08/2008, 55°N). The larger extinction values observed in the southern hemisphere winters are due to the presence of polar stratospheric clouds.

Optical Path

path followed by the light during its propagation.

Plinian Volcanic Eruptions

Plinian eruptions, also known as Vesuvian eruptions, are named after Pliny the Younger, a Roman statesman who wrote a remarkably objective account of the eruption of Italy's Mt. Vesuvius in 79 AD. This type of volcanic eruptions, resembling this eruption of Mount Vesuvius, are characterized by columns of gas and volcanic ash extending up to 45 km into the stratosphere.

Selected References

Fussen, D., F. Vanhellemond and C. Bingen (2001), Evidence of transport, sedimentation and coagulation mechanisms in the relaxation of post-volcanic stratospheric aerosols, *Annales Geophysicae*, 19(9), 1157-1162, doi:10.5194/angeo-19-1157-2001.

Vanhellemond, F., D. Fussen, N. Mateshvili, C. Tétard, C. Bingen, E. Dekemper, N. Loodts, E. Kyrölä, V. Sofieva, J. Tamminen, A. Hauchecorne, J.-L. Bertaux, F. Dalaudier, L. Blanot, O. Fanton d'Andon, G. Barrot, M. Guirlet, T. Fehr and L. Saavedra (2010), Optical extinction by upper tropospheric/stratospheric aerosols and clouds: GOMOS observations for the period 2002-2008, *Atmospheric Chemistry and Physics*, 10(16), 7997-8009, doi:10.5194/acp-10-7997-2010.

TWILIGHT OBSERVATIONS

Nina Mateshvili

Sky Brightness Measurements

Photometric measurements of the twilight sky brightness at one or more wavelengths are able to give some quantitative estimates of stratospheric aerosol loading. After the sunset, an observer which is situated on the Earth's surface is not able to see the direct solar light anymore, but the sky remains illuminated for about an hour and a half, highlighting gradually higher and higher atmospheric layers and offering to the eye the changing colours of the sunlight scattered by the molecular atmosphere and by aerosols. When sunlight passes at the level of the aerosol layer, it undergoes intense multiple scattering on the many aerosol particles. The resulting effect is an increase of the intensity of the light scattered toward the observer on the ground.

Satellite image of Ethiopia/Eritrea showing the ash plume from the Nabro volcano eruption on 13 June 2011.



Aerosol Extinction

The removal of radiant energy from an incident beam by the process of aerosol absorption and/or scattering per kilometer.

Aerosol Optical Depth

A measure of how opaque a medium is to radiation passing through it.

Radiative Transfer

Theoretical method used to describe the light propagation through a scattering and absorbing medium, possibly with a complex configuration.

Sky Brightness

The amount of the sunlight scattered by the unit area of the sky towards the observer.

Solar Zenith Angle

The angle between the line observer-local zenith and the line observer-the Sun.

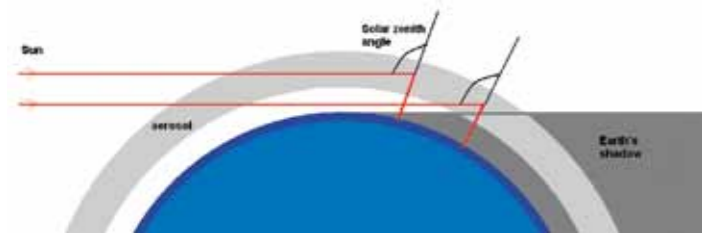

Twilight event scheme.



The Charge-Coupled Device (CCD) spectrometer used for measurements and the twilight sky above Tbilisi at the solar zenith angle about 93° colored after the Nabro eruption.

The path, the Sun's rays travel through the aerosol layer before being scattered towards the observer, varies during the morning or evening twilight with the position of the Sun below the horizon, quantified by the solar zenith angle. Consequently, the twilight sky brightness measured from the ground by a photometer will vary as a function of time or, equivalently, as a function of solar zenith angle. In presence of the dense stratospheric aerosol layer the variation looks like a "hump" on the twilight curve measured by the photometer; actually stored as the logarithm of the twilight sky brightness as a function of the solar zenith angle.

As the evening twilight progresses, the stratospheric aerosol layer is first illuminated tangentially. Grazing Sunrays pass through almost the whole thickness of the layer before they are scattered towards the ground. When the Sun sinks deeper below the horizon, its rays slant through the aerosol layer, pass below the layer, penetrate into it once more and then are scattered towards the observer situated on the ground. Finally, the aerosol layer appears to be totally shadowed by the Earth and contributes only to the attenuation of the light scattered in the atmospheric regions above the layer, towards the observer.

The variations of twilight sky brightness with stratospheric aerosol load can be used to estimate the optical depth of aerosol layers in the upper troposphere and lower stratosphere. This quantity reflects the light attenuation due to the presence of the aerosol particles as it propagates through the atmosphere.

Aerosol Studies at BIRA-IASB, using Twilight Measurements

Twilight measurements were initiated by Abastumani Astrophysical Observatory and carried out routinely above Tbilisi, Georgia. This time series allowed observing major volcanic eruptions such as the Pinatubo eruption in 1991 and more recently the Nabro eruption in 2011. Collaboration was initiated between the Abastumani Astrophysical Observatory and BIRA-IASB in 2004, and the twilight measurements were processed as a common work with BIRA-IASB and Finnish Meteorological Institute. This common study applied to the observation of the major eruptions gave rise to several publications.

The eruption of Nabro, a stratovolcano located in Eritrea occurred on 13 June 2011. The air masses, which were above the volcano at the time of the eruption and at the plume altitude, were transported later towards Georgia, South Caucasus. Red sunsets were observed above Tbilisi, Georgia throughout July 2011.

Retrieving the Features of the Aerosol Layer from Twilight Measurements

The twilight sky brightness measurements were modeled in spherical atmosphere approximation to take into account the Earth's curvature. Retrieving the atmospheric features from twilight sky brightness measurements is not an easy task. As mentioned above, the sunlight, before entering the spectrometer, undergoes many acts of scattering on aerosol particles and air molecules (multiple scattering) that have to be rebuilt by

simulations of the light propagation through the atmosphere. The signal processing is then carried out using a radiative transfer technique that simulates the light propagation through the atmosphere, taking into account scattering and absorption caused by its main components, amongst which the encountered aerosol particles. By simulating in this way the propagation of many light rays through all illuminated regions of the atmosphere, it is possible to obtain a quite realistic view of the light signal received by the photometer. The aerosol content of the atmosphere can then be rebuilt by testing different scenarios and by identifying the most probable case. Fitting the experimental data by the modeled ones allows retrieving the aerosol extinction profiles as a function of the altitude. Stratospheric aerosol layer optical depths can then be computed via integration of aerosol extinction profiles over altitude.

The enhanced stratospheric aerosol layer persisted above Tbilisi at about 17 km altitude from July to the beginning of August 2011 after the eruption of Nabro, and aerosol extinction profiles were retrieved from twilight observations. This shows that these measurements give a way to estimate the aerosol load in the stratosphere above the observation site with the aid of a cheap and simple technique, and to participate this way in the global monitoring of major volcanic eruptions.

Selected References

Matshvili, N., D. Fussen, F. Vanhellemont, C. Bingen, E. Kyrölä, I. Matshvili and G. Matshvili (2005), Twilight sky brightness measurements as a useful tool for stratospheric aerosol investigations, *Journal of Geophysical Research: Atmospheres*, 110(D9), D09209, doi:10.1029/2004JD005512.

Matshvili, N., D. Fussen, G. Matshvili, I. Matshvili, F. Vanhellemont, E. Kyrölä, S. Tukiainen, J. Kujanpää, C. Bingen, C. Robert, C. Tétard and E. Dekemper (2013), Nabro volcano aerosol in the stratosphere over Georgia, South Caucasus from ground-based spectrometry of twilight sky brightness, *Atmospheric Measurement Techniques*, 6(10), 2563-2576, doi:10.5194/amt-6-2563-2013.

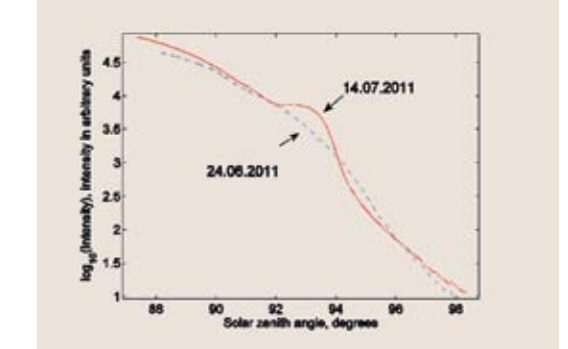

Twilight curves acquired at wavelength 780 nm before (June 24th, 2011, blue dashed line) and after (July 14th, 2011, solid red line) the airmasses, rich in volcanic aerosols, appeared above Georgia. The curve acquired at July 14th shows the "hump" caused by the stratospheric aerosol layer enriched with the Nabro aerosol.

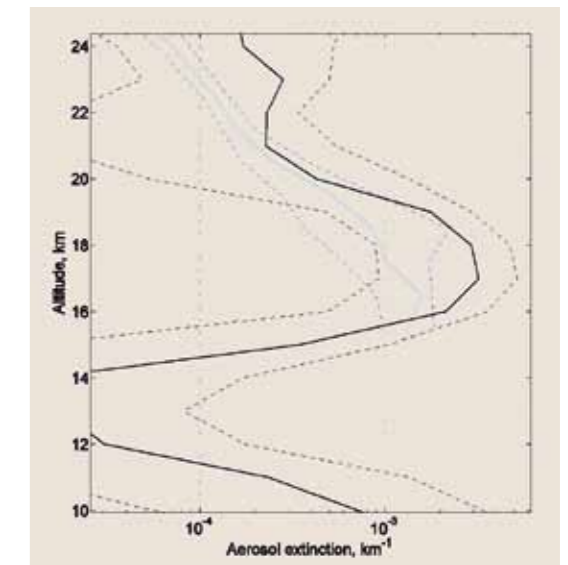

The averaged aerosol extinction profile (black solid curve) retrieved from twilight measurements. The black dashed lines represent the profile variability. The aerosol extinction profiles retrieved from the OSIRIS (Optical Spectrograph and InfraRed Imager System) measurements are presented by blue lines for comparison purposes.

CHARACTERIZATION OF STRATOSPHERIC AEROSOLS

Christine Bingen and Christian Muller

Pioneering Aerosol Studies at BIRA-IASB: a Balloon Story

BIRA-IASB's know-how in terms of aerosols is the result of a long tradition. First aerosol studies were closely related to stratospheric balloon flights. At that time, BIRA-IASB's interest concerned electrified aerosols, which were studied by measuring conductivity changes in conducting plates hanging to the gondola while entering the stratosphere.

The eruption of Mount St-Helens in 1980 is a key event for aerosol studies at BIRA-IASB, with the first observation of the aerosol layer from a stratospheric balloon. Scattering measurements are used to retrieve the aerosol concentration and size from extinction measurements. From 1968, an eight-bit IBM 1800 computer with 32 kB memory is used for this purpose. It is replaced in 1977 by a UNIVAC 1108 computer. The results provided by this 36 bits machine must be considered very cautiously due to rounding errors. The scientists make use of routines provided by the National Center for Atmospheric Research, NCAR (Boulder, Colorado). These routines, written for a CRAY computer, had to be adapted for this specific use, a very hazardous task in view of the code features at that time. Each result had to be validated first using a published case and reproducing it. The use of statistical methods in scattering calculations was tempted in collaboration with the University of Lille, in order to verify the relationship between direct and diffused radiation. But these studies were rapidly abandoned in view of the inextricable complexity of the error estimation and of the interpretation of the results. After 1992, much better performing UNIX machines replace the UNIVAC computer.

Turning Point: the ORA Experiment

The growing participation of BIRA-IASB to space experiments from the early nineties results in new developments of aerosol characterization activities. The ORA experiment on board the EURECA platform, originally foreseen to fly in 1988, is finally launched in August 1992. This lucky delay makes the instrument a privileged spectator of the period following the eruption of the Mount Pinatubo in June 1991, a major milestone in aerosol research. The mission is a success and leads to the production of aerosol datasets of a remarkable quality in view of its design. This instrument, dedicated to microgravity measurements, observes the image of the whole Sun focussed on a single point. Such an extremely wide field of view embracing the sun and surroundings, leads to exceptional signal-to-noise ratios. However, it is not well suited for the retrieval of aerosol profiles with a typical vertical resolution of about 1-2 km. The ORA team takes over the inversion of the aerosol measurements and derives an aerosol extinction dataset over the whole mission (August 1992-May 1993). In view of the complexity of this ill-conditioned problem, the agreement with reference datasets such as the one from the NASA experiment SAGE II, is remarkably good.



Integration of the Occultation Radiometer ORA in the mechanical workshop.



Cutaway of the Occultation Radiometer ORA.

The ENVISAT Era

The nineties are marked by the start of the ENVISAT programme, a large ESA satellite launched in February 2002. Amongst the dozen of instruments on board, the GOMOS experiment is based on the pioneering concept of stellar occultation. While traditional solar occultation provides two measurements per orbit (one at sunrise and one at sunset), the use of stars allows a dramatic increase of the data rate up to 40 occultation measurements per orbit. In 1995, the Institute endorses the responsibility of the aerosol retrieval from GOMOS. This theme, considered at that time as a minor topic without much interest by the main European research teams, is left to our small country. For the Institute, however, it is a very suitable way to use and further develop its expertise obtained from the ORA experiment. Grasping this opportunity allows BIRA-IASB to become one of the main actors in stratospheric aerosol studies in Europe.

The SAGE II Experiment: 16 Years of Aerosol Observation from Space

During the following decades, the growing aerosol team develops aerosol characterization activities around another satellite mission: the NASA SAGE II experiment. Launched in 1984, about 30 months after the major volcanic eruption of El Chichón in March-April 1982, this mission continued its measurements till 2005, providing a unique time series covering several major eruptions (Ruiz, 1985; Kelut, 1990, Mt Pinatubo and Serra Hudson, 1991), as well as two periods of very low volcanic load around 1989 and after 1996. BIRA-IASB makes use of this opportunity to develop new aerosol studies. Whereas extinction was formerly used to characterize parameters, the 4 spectral channels of SAGE II open new possibilities. The signals expected from these four channels will depend on the size of the aerosol particles, and hence, the spectral response can provide information about the particle size on a statistical basis. The problem is investigated successfully at BIRA-IASB, with the publication of the first global time series of size information and particle density for the period 1984-2000. Different studies result from these achievements. The very slow decay, from 1990 to about 1996, of the huge aerosol cloud produced by the Pinatubo eruption, is a precious data source to study how aerosols gradually migrate toward the poles, how the droplet size can change during their existence (formation of condensation nuclei, growth by condensation, coagulation of several droplets, and finally removal by sedimentation), how their concentration varies in time and space under the influence of transport, following the dynamical features and patterns of the general stratospheric circulation around the globe, and how their abundance is influenced by external factors such as cosmic rays.



ENVISAT in the clean room at ESTEC. (credit: ESA)

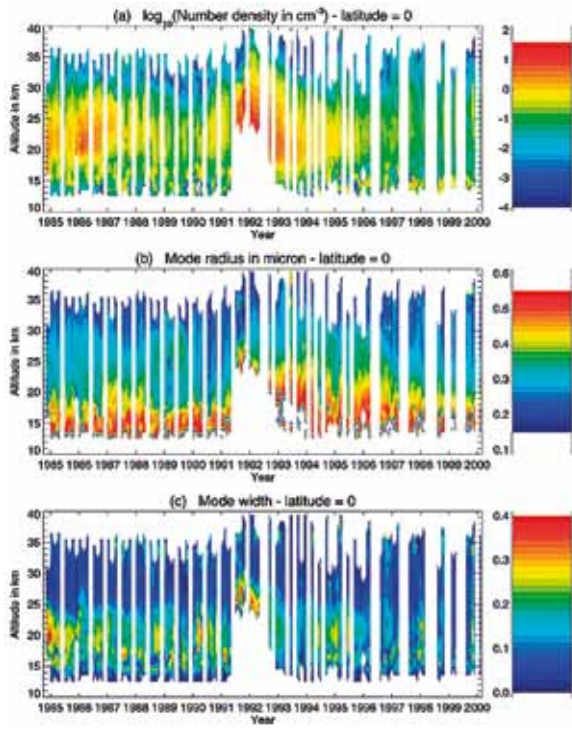

Evolution in time and altitude of characteristic aerosol parameters:
 (a) particle concentration expressed by its decimal logarithm,
 (b) the mode radius, representative for the particle size on average, and
 (c) width of the particle size distribution.
 These results are based on SAGE II data for the entire duration of the mission, 1984-2000.

GOMOS: Past, Present, and Future

The GOMOS experiment poses new challenges in terms of aerosol retrieval methods. Contrary to ORA which embraces the solar disk as a whole, GOMOS points to stars to scan the atmosphere, and sees, like observers on the ground, scintillation effects due to turbulences in the atmosphere. The weakness of the star signal and the need to remove scintillation from the noisy measurements offer new challenges to researchers. BIRA-IASB's aerosol team continues to work on the development of more accurate and performing retrieval algorithms, allowing to provide the best quantification of aerosol parameters (extinction, size distribution, etc.) needed to constrain large climate models, to validate other satellite experiments, and to prepare satellite missions of tomorrow such as BIRA-IASB's ALTIUS mission.

During the past 50 years, BIRA-IASB has been able to grasp opportunities, often as niche projects in the shadow of the contributions of large international research groups. From the glorious past marked by the stratospheric balloon flight to the GOMOS adventure, the Institute succeeded in developing an expertise in aerosol sciences that is appreciated and recognized today as highly valuable by the international community.

Selected References

Bingen, C., D. Fussen and F. Vanhellemont (2003), A global climatology of stratospheric aerosol size distribution parameters derived from SAGE II data over the period 1984-2000: I. Methodology and climatological observations, *Journal of Geophysical Research: Atmospheres*, 109(D6), D06201, doi:10.1029/2003JD003518.

Fussen, D., E. Arijs, F. Leclère, D. Nevejans and C. Bingen (1997), Tomography of the Earth's atmosphere by the spaceborne occultation radiometer ORA: Spatial inversion algorithm, *Journal of Geophysical Research: Atmospheres*, 102(D4), 4357-4365, doi:10.1029/96JD03001.

TROPOSPHERIC REMOTE SENSING OBSERVATIONS BY INFRARED ATMOSPHERIC SOUNDING INTERFEROMETER

Sophie Vandebussche

Progress Towards Tropospheric Observations from Satellites: Thermal Infrared Measurements

Aerosols observations have been for a long time undertaken using measurements at ultraviolet and visible wavelengths. In that case, the light comes from the Sun, and is reflected, scattered or absorbed by gases and aerosols present in the atmosphere. More recently, the scientists have started using Thermal InfraRed (TIR) measurements to obtain additional information about the aerosols. In that case, the wavelengths used correspond to the thermal emission of any object at a temperature close to that of the Earth. That means that the light observed by TIR satellite instruments has been emitted by the Earth surface, and all gases and aerosols in the atmosphere. Before this light reaches the satellite instrument, it may, as for UV and visible light, be reflected, scattered or absorbed by aerosols and gases (although TIR scattering by gases is extremely weak). Using TIR measurements to get information about the atmosphere has an additional advantage over UV and visible measurements: it does not require sunlight, therefore allowing measurements also during the night. On the other hand, even though insensitive to solar zenith angles, TIR emissions are still subject to daily and annual cycles because they depend on the Earth surface and atmosphere temperatures, which in turn depend partly on sunlight.

About 10 years ago, BIRA-IASB started preliminary studies of aerosol retrievals from TIR measurements, that were published in 2006. For the next few years, the subject was more or less abandoned to be revived in 2011 with the beginning of desert dust (sand) and volcanic ash aerosols studies using IASI instruments (see section "IASI", chapter 8). These instruments, Infrared Atmospheric Sounding Interferometers, fly on board satellite platforms (MetOp), looking down to the Earth and measuring the radiation exiting the atmosphere in the near-, mid- and far-infrared. IASI instruments are well suited for long-term studies, ensuring a continuous and consistent TIR data record from 2006 to at least 2030 (by successive launches).

Aerosols Retrievals, an Unexpected Use of IASI Data for Climate Studies and Aviation Hazard Prevention

IASI was initially designed to obtain vertical profiles of temperature and water vapour with high vertical resolution and accuracy, to be used for meteorological applications. Data from IASI have however been largely used for atmospheric chemistry applications, which was not foreseen at the time of conception. One of these applications is the retrieval of aerosol atmospheric load (concentration, altitude) and properties (particle size, refractive index, mineral composition ...). As mentioned, at BIRA-IASB, the focus has been set on desert dust and volcanic ash studies.

Brightness Temperature

Temperature of a black body (perfect emitter) that would emit the measured radiance; this unit is often used when looking at TIR data

Radiative Effect

Effect on the radiance, which is the amount of energy (light) that passes through or is emitted from a surface within a given solid angle; radiative effects (of an object, gas, aerosol) are due to light emission, absorption and/or scattering

Retrieval

Term commonly used in atmospheric sciences to refer to the process during which information is retrieved from measurements (no matter from which instrument) using a physical model of the interaction of light with the atmosphere (radiative transfer) and a mathematic algorithm



Air pollution hangs in the air lowering visibility towards central London and the City from east London, on April 2, 2014. Saharan dust mixed with pollution from Europe and the UK has blanketed a large area of the country, raising air pollution levels to dangerous levels. (credit AFP PHOTO/Leon Neal)

Desert dust is windblown from arid areas mainly in the Tropics and can be transported over long distances (up to Europe) before “falling off the sky”, as a yellow “sandy” dust. This aerosol is the most important one (in annual mass burden) in the troposphere. Most of its sources are natural, but the anthropogenic part is also non-negligible, and related to the land use. At the current state of the science, the uncertainties regarding desert dust retrievals make it extremely hard to assess its global impact on the climate. It is even unsure if desert dust is cooling or heating the Earth and its atmosphere. Any improvement in knowledge about dust and its radiative effects is therefore very important and in particular the vertical distribution of this aerosol should be better known but it is poorly characterized at present.

Volcanic ash is blown in the troposphere or even low stratosphere by explosive eruptions, and then transported depending on its height and on the winds. Ash may stay long enough in the atmosphere to make a few rounds around the globe. Volcanic ash represents a very significant hazard for aviation, as it melts at the engines temperature, causing them to block. An improved knowledge of the 3D distribution of ash would be of great interest not only to the scientific community but also to the civilians through the improvement of aviation hazards mitigation.

At BIRA-IASB, a new strategy is under development to retrieve for the first time vertical profiles of desert dust and volcanic ash from TIR measurements by IASI. Results of this work are expected to be a great contribution to climate studies and to hazard mitigations.

Long Expertise... and State-of-the-art New Algorithms

The work undertaken at BIRA-IASB on desert dust and volcanic ash benefits from a very long expertise in the simulation of thermal emission and of light propagation in the atmosphere in the presence of gases and aerosols (the ASIMUT algorithm used in the analysis of Venus Express data). This expertise has been completed by the use of a well-recognised state-of-the-art scientific algorithm allowing to model the interaction of aerosol particles with light, not only through absorption and emission but also through multiple scattering (Lidort, RTSolutions). The correct simulation of multiple scattering by a particle requires the knowledge of its size, shape and composition, which is a true challenge because only few direct measurements of these have been undertaken, and because those properties vary with each dust outbreak event or volcanic eruption.

For desert dust and volcanic ash aerosols investigation from TIR measurements, the most commonly used spectral band is the so-called “atmospheric window” (about 8.3 to 12.5 μm). The name of this spectral band arises from the fact that there is very few gas absorption at those wavelengths (except for a strong ozone absorption at about 9.7 μm), therefore in the absence of clouds almost all thermal emission from the planet may escape to space, as if going through an open window, while at other wavelengths more light (or energy) is trapped within the atmosphere by gas absorption (causing the greenhouse effect). The atmospheric window is

suited for looking at desert dust and volcanic ash aerosols from space because those aerosols have a radiative signature (they cause a specific measurable change in radiation) in that window, and that signature remains apparent in the radiation until the top of the atmosphere because only little gas absorption occurs. At other wavelengths, where atmospheric gases absorb more light, the aerosol signature may be present but is partly (or completely) erased by gas absorption above the aerosol layers.

Future Developments

There are numerous possibilities for future development of these activities within BIRA-IASB in the coming years/decades besides the improvement of the existing retrievals. For example, it is currently planned to develop the retrieval of aerosols micro-physical properties (size, refractive index, shape).

Selected References

Kochanova, S., M. De Mazière, N. Kumps, S. Vandebussche and T. Kerzenmacher (2013), Retrieval of volcanic ash and ice cloud physical properties together with gas concentration from IASI measurements using the AVL model, AIP Conference Proceedings, 1531, 103-106, doi:10.1063/1.4804718.

Kruglanski, M., M. De Mazière, A. C. Vandaele and D. Hurtmans (2006), Boundary layer aerosol retrieval from thermal infrared nadir sounding – Preliminary results, *Advances in Space Research*, 37(12), 2160-2165, doi:10.1016/j.asr.2005.08.032.

Vandebussche, S., S. Kochanova, A. C. Vandaele, N. Kumps and M. De Mazière (2013), Retrieval of desert dust aerosol vertical profiles from IASI measurements in the TIR atmospheric window, *Atmospheric Measurements Techniques*, 6(10), 2577-2591, doi:10.5194/amt-6-2577-2013.

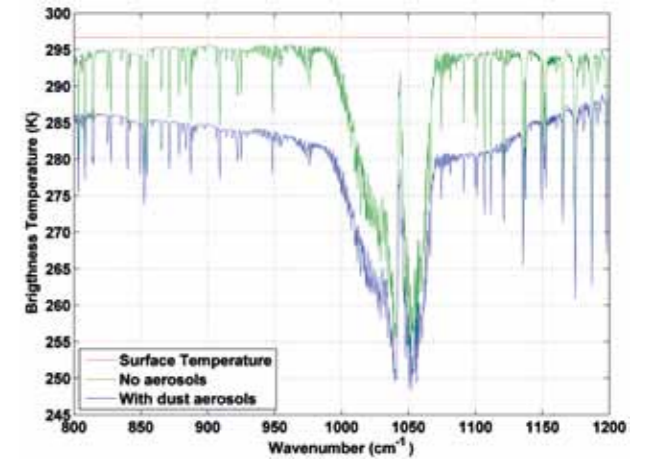

Simulation of a Thermal Infrared Spectrum in the so-called “atmospheric window”, in the absence of aerosols (green) and in the presence of a 1 km-thick layer (between 4 and 5 km altitude) of desert dust aerosols at a concentration of 250 particles/cm³, corresponding to an important dust event (blue). The presence of aerosols clearly cause a general reduction of the brightness temperature compared to the applied surface temperature (red), with first a negative and then a positive slope. Most of the absorption lines visible in the spectrum are due to water vapour; while the deep, broad absorption line around 1030 cm⁻¹ is due to ozone.

Scattering

Physical process during which light is forced to deviate from its trajectory due to non-uniformities in the medium it passes through; when this process occurs multiple times for the same light beam, it is called multiple scattering

Thermal Emission

Electromagnetic radiation (light) emitted by all matter at non-zero temperature following Planck's law (with adaptations depending on the composition and surface of the emitting matter)

13



BELGISCH INSTITUUT VOOR RUIMTE-AERONOMIE (BIRA) INSTITUUT D'AERONOMIE SPATIALE DE BELGIQUE (IASB) BELGIAN INSTITUTE FOR SPACE AERONOMY (BIRA-IASB) BELGISCH INSTITUUT VOOR RUIMTE-AERONOMIE (BIRA) INSTITUUT D'AERONOMIE SPATIALE DE BELGIQUE (IASB)

PLANETARY ATMOSPHERES

Ann Carine Vandaele and Frank Daerden



Colour image of comet and massive tail over the ocean. (credit: NASA)

Ann Carine Vandaele and Frank Daerden

BIRA-IASB has a long-standing tradition regarding the studies of the atmospheres of the Earth as well as its sister planets Mars and Venus. The study of these Earth-like planets, of which the atmospheres have evolved towards different yet extreme conditions, is a vital part of the understanding of the past and future of our subtle climate system. Indeed, a more detailed understanding of the dynamics and atmosphere circulation on the other planets, of the forces which drive them, and of the interesting phenomena like precipitation, storms, lightning, atmospheric photochemistry, and polar vortex occurring on other planets than Earth will eventually lead to an integrated and deep comprehension in atmospheric science, atmospheric dynamics and planetary meteorology, which will, in turn, benefit the better understanding of similar phenomena happening on Earth.

Earth's solar system has four terrestrial planets: Mercury, Venus, Earth and Mars. During the formation of the Solar System, there were probably many more (planetesimals), but they have all merged with or been destroyed by the four remaining worlds in the solar nebula. Only one terrestrial planet, Earth, is known to have an active hydrosphere. Telluric planets are composed mostly of some combination of hydrogen, helium, and water existing in various physical states. They all have roughly the same structure: a central metallic core, mostly iron, with a surrounding silicate mantle. Telluric planets possess secondary atmospheres, generated through degassing, internal volcanism or comet impacts, as opposed to the gas giants, which possess primary atmospheres, captured directly from the original solar nebula. In this respect, Mars and Venus are very similar to Earth in several aspects such as their composition, but their differences can learn us a lot more.

Mars lost its magnetosphere 4 billion years ago, causing the solar wind to interact directly with the Martian ionosphere, keeping the atmosphere thinner than it would have been otherwise, by stripping away atoms from

the outer layer. In contrast to the Earth atmosphere, which is composed of roughly 78% nitrogen, 21% oxygen, 0.93% argon, 0.04% carbon dioxide, with very small percentages of other elements such as water vapour, the atmosphere on Mars consists of 96% carbon dioxide, 1,9% nitrogen, 1,9% argon, and contains traces of oxygen and water. The atmosphere contains quite a lot of dust particulates giving the Martian sky a tawny colour when seen from its surface.

Venus, on the other hand, has an atmosphere which is much denser and heavier than the one of Earth and which extends to a much higher altitude. Venus radio observations gathered from Earth published in 1958 showed an amazingly hot temperature, upwards of 600 Kelvin, which was confirmed by the flybys of Mariner 2 in 1962. This high temperature could not be explained at that time. Slowly the idea of an exceptional greenhouse effect emerged.

BIRA-IASB's interest in planetary space missions started from its formation in the 1960s and the institute has actively taken part in several successful missions to Mars (Phobos, Mars-Express) and Venus (Venus-Express) and provided science support to the interpretation of data from the NASA Phoenix lander mission. The institute will consolidate its leading position in planetary aeronomy, by being Principal Investigator of the NOMAD suite of instruments on the ESA ExoMars Trace Gas Orbiter (EMTGO, launch in 2016).

THE PHOBOS OBSERVATIONS

Christian Muller



Phobos as seen by the HRSC nadir channel during Mars Express mission. (Credit: ESA/DLR/FU Berlin -G. Neukum)

The success of NASA's Viking mission of 1976 instigated a strong interest at the Belgian Institute for Space Aeronomy towards Mars. The Viking mission was designed to obtain high resolution images of the Martian surface, to characterize the structure and the composition of the atmosphere and the surface, and to search for evidence of life processes on Mars. Instead, it discovered incredible chemical processes corresponding to an unknown surface oxidant.

At that time, ESA started the study of a mission to Mars called Kepler to perform an inventory of its atmospheric composition and chemistry. BIRA-IASB proposed a national contribution with a Belgian instrument, a UV-visible-infrared optical package, designed to perform limb sounding of the Martian atmosphere. This instrument was never developed but its concept was proven and published at ESA workshops. ESA finally stopped funding Kepler after the Mission Analysis phase without ever clearly deciding to abandon the project. However, the concept interested French scientists from the "Service d'Aéronomie du CNRS" who designed a similar package for the Phobos mission, in collaboration with the Russian Space Research Institute (IKI).

The Phobos mission was a very sophisticated Soviet mission to Mars and one of its two moons, Phobos. Using two spacecrafts, it combined in situ measurements on and near Phobos and remote sensing of both Mars and Phobos. Although unaware of this parallel development, BIRA-IASB finally got involved in the project in 1987, when a delegation of IKI visited Brussels. They offered BIRA-IASB to participate in the characterization and testing of this new instrument, called Auguste. This experiment was devoted to solar occultation spectroscopy of the Martian atmosphere in the ultraviolet through infrared wavelength region. Three flight models of the spectrometer were built in IKI and one of them was handed over to BIRA-IASB for testing. One of the measurements involved observations of the Sun at the Pic du Midi Observatory.

The two Phobos satellites were launched in 1988. Unfortunately, only one of the spacecrafts, Phobos 2, arrived at the planet in 1989 and obtained a limited set of observations. The AUGUSTE instrument on board the Phobos 2 spacecraft was in operation from the beginning of its orbital flight around Mars (the first communication session was performed on February 8, 1989) until about the end of the Phobos mission (the last observation was carried out on March 26, 1989). The instrument delivered invaluable information on the water and ozone content of the atmosphere, as well as on the structure of clouds and aerosols. In 1993, BIRA-IASB and IKI researchers published the first "tentative identification of formaldehyde in the Martian atmosphere". Indeed, two absorption features were observed in some AUGUSTE spectra, and the scientists

proposed formaldehyde as being the origin of these structures. This had a lot of impacts on the known photochemistry occurring on Mars because formaldehyde is a product of the oxidation of methane, which at that time had never been observed on Mars. However, a recent re-analysis of these spectra by Korablev (2002) showed that the observed structures could be due to an instrumental artefact. Moreover, a recent observation of weak CO₂ absorption in the same spectral region was proposed by Bertaux and co-workers to explain the features observed in the Phobos spectra.

The partial success of this limb sensor encouraged the same Belgo-Franco-Russian team to propose the "Spectroscopy for Investigation of Characteristics of the Atmosphere of Mars" (SPICAM) instrument on Mars-96 and Mars-Express (see section "Mars Express" in this chapter). The concept was further developed and led to the "Solar Occultation in the IR" (SOIR) instrument, a new original Belgian-led design. A SOIR instrument is currently on board the ESA Venus Express mission (see section "Venus Express" in this chapter). It has been selected to be on the next ESA mission to Mars as well: the ExoMars Trace Gas Orbiter mission to be launched in 2016, as part of the "Nadir and Occultation for MArS Discovery" (NOMAD) suite of spectrometers (see section "NOMAD" in this chapter).

Selected References

Bertaux, J., A. C. Vandaele, V. Wilquet, F. Montmessin, R. Dahoo, E. Villard, O. Korablev and A. Fedorova (2008), First observation of 628 CO₂ isotopologue band at 3.3 micrometre in the atmosphere of Venus by solar occultation from Venus Express, *Icarus*, 195(1), 28-33, doi:10.1016/j.icarus.2008.01.001.

Korablev, O. (2002), Solar Occultation Measurements of the Martian Atmosphere on the Phobos Spacecraft: Water Vapor Profile, Aerosol Parameters, and Other Results, *Solar System Research*, 36(1), 12-34, doi:10.1023/A:1014269426317

Korablev, O. I., M. Ackerman, V. A. Krasnopolsky, V. I. Moroz, C. Muller, A. V. Rodin and S. K. Atreya (1993), Tentative identification of formaldehyde in the Martian atmosphere, *Planetary Space Science*, 41(6), 441-451, doi:10.1016/0032-0633(93)90004-L.

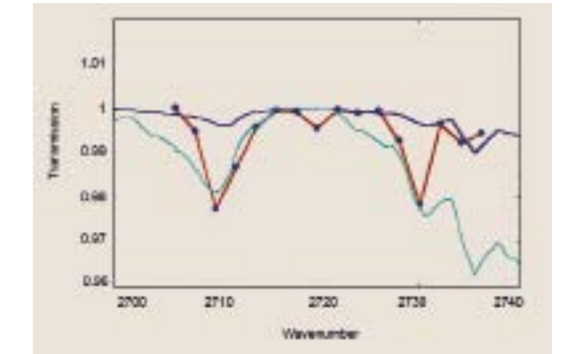

Comparison of a Martian spectrum (blue dots) at 17 km limb altitude with two synthetic spectra (in blue and green) of formaldehyde computed in similar Martian conditions

MARTIAN ATMOSPHERE EXPLORATION WITH MARS EXPRESS

Nina Mateshvili and Eddy Neefs
With contributions from Yannick Willame

Mars Express ESA Mission

Mars Express owns its name to the speed and efficiency with which the spacecraft was designed, built and launched (it took only five years from mission approval to launch), at a much lower cost than previous similar missions. However, “Express” also describes the spacecraft’s relatively short interplanetary voyage, a result of being launched at the moment when the orbits of Earth and Mars brought them closer than they had been in about 60,000 years. It carries seven scientific instruments on board and deployed a lander, Beagle 2. The lander was lost during its attempt to reach the planet’s surface but the orbiter continued its highly successful global investigation of Mars and its two moons, Phobos and Deimos. *Mars Express* was launched from the Baikonur launch pad in Kazakhstan on a Soyuz-Fregat launcher on 2 June 2003. Due to the valuable science return and the highly flexible mission profile, *Mars Express* has been granted five mission extensions. In fact, in 2013, we celebrated the 10 year anniversary of the mission.

Mars Express (MEX) is Europe’s first mission to the Red Planet and even its first planetary mission. It was launched on June 2003 and arrived around the planet on December 2003. BIRA-IASB has been involved in one of the instruments on board: Spectroscopy for Investigation of Characteristics of the Atmosphere of Mars (SPICAM) which is a spectrometer with two channels, one for the ultraviolet and one for the infrared radiation. BIRA-IASB worked in close collaboration with the French CNRS laboratory “Service d’Aéronomie” (now LATMOS: “Laboratoire Atmosphères, Milieux, Observations Spatiales”), and the Russian Space Research Institute (IKI) in the definition of the scientific objectives. SPICAM retrieves information about the amount of ozone (with the UV sensor at 250 nm) and water vapour (with the IR sensor at 1.38 micron) in the Martian atmosphere for different seasons, using three different observing modes: solar occultation, stellar occultation and nadir measurements.

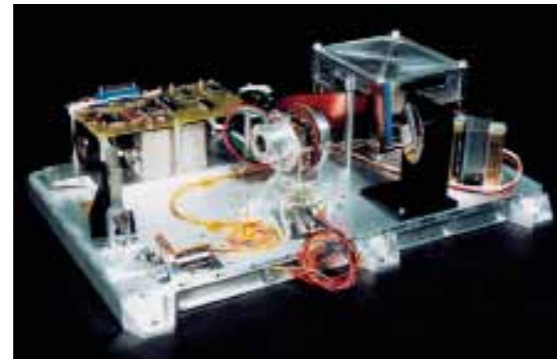

SPICAM Qualification Model.



Flight Model Sensor Unit of SPICAM viewed from above. The IR acoustooptical tunable filter spectrometer is at top; the UV spectrometer is at bottom. The common optical axis points to the left. For the UV spectrometer, the light enters the mechanical baffle (black), is focused by a parabolic mirror (bottom right) through a slit, then dispersed by the grating (middle left), to be refocused on the intensified Charge-Coupled Device (CCD) Detector (at centre).

BIRA-IASB was responsible for the mechanical design, manufacturing, assembly, and integration of the support structure for the individual optical parts, the electronic boards and the cabling, building on heritage from the previous SPICAM instrument on board the Russian MARS-96 mission. To differentiate between both instruments, one often uses the name SPICAM-Light for the instrument on board Mars Express. The name was given after a redesign operation to drastically reduce the mass of the instrument. BIRA-IASB carried out very specific tasks such as hardware manufacturing of certain subassemblies, surface treatment and optical testing in collaboration with Belgian and foreign industrial partners.

SPICAM operates in the UV domain, which is favourable for the detection of Martian aerosols. Bright ice clouds are clearly visible in the UV against the background of dark Martian soil in nadir observing mode. The Martian soil is red in the visible wavelength domain and becomes very dark in the UV due to strong absorption of the UV radiance by iron-containing minerals which are abundant on Mars.

The ice cloud appearance has very prominent seasonal variations and spatial distribution. Scientists are deeply interested in the Martian ice cloud distribution and its yearly cycle because the cloud formation is clearly connected with the Martian atmospheric general circulation and the water cycle. During the northern winter, thick clouds cover the Martian North Pole, forming the north polar hood. As spring progresses, clouds retreat northwards in parallel with seasonal ice. Only a few ice clouds stay above the North Pole during the summer season.

The released water vapour rushes towards the equator where it is picked up by the ascending branch of the Hadley circulation. The rising water vapour reaches altitudes where low temperatures and pressures create favourable conditions for cloud condensation. Clouds form the so-called Aphelion cloud belt which is persistent during the whole northern summer. At the same time cloud cover grows above the South Pole forming the south polar hood. When the northern fall starts, the North polar hood grows and the South polar hood retreats. Due to the highly elliptical orbit of Mars the southern summer is much hotter than the northern one. This is a season of strong dust storms which sometimes even cover the whole planet. Clouds disappear almost everywhere and survive only above the North Pole. Only during southern fall, rare clouds start to form above high Martian volcanoes and the cloud cycle starts again.

Martian solar longitude (Ls)

Scientists studying seasonal changes on Mars often use the heliocentric or solar longitude, Ls, to indicate the season. Ls indicates the location of Mars in its orbit around the Sun. It is the angle between the line connecting the Sun to the position of Mars in its orbit and the planet position at northern hemisphere spring equinox. Ls is therefore 0° at the Martian northward equinox, 90° at the Martian summer solstice, 180° at the Martian southward equinox, and 270° at the Martian winter solstice.

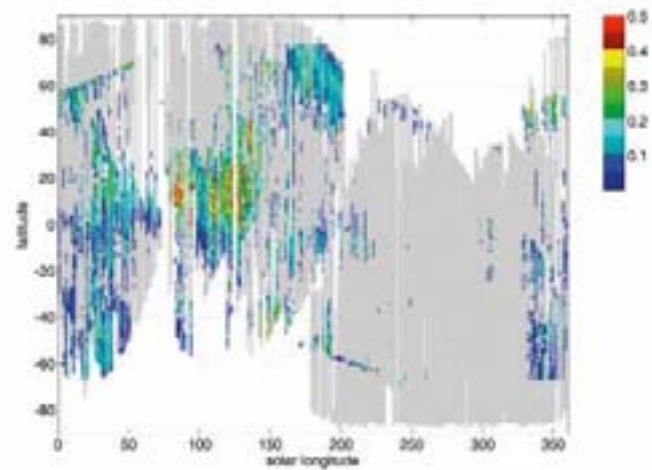

Martian ice clouds: zonally averaged optical depth distribution depending on the Martian season. Data were acquired during Martian years 26, 27, 28, and 29. The map is superimposed on SPICAM's orbit distribution (grey background).

Martian Year:

Martian Years (MY) are numbered according to the calendar proposed by R.T. Clancy: Martian Year 1 begins at the northern Spring equinox of April 11th, 1955 (i.e. at a time where $L_s = 0^\circ$).

Selected References

Bertaux, J.-L., D. Fonteyn, O. Korabiev, E. Chassefière, E. Dimarellis, J. P. Dubois, A. Hauchecorne, F. Lefèvre, M. Cabane, P. Rannou, A. C. Levasseur-Regourd, G. Cernogora, E. Quemerais, C. Hermans, G. Kockarts, C. Lippens, M. De Maziere, D. Moreau, C. Muller, E. Neefs, P. C. Simon, F. Forget, F. Hourdin, O. Talagrand, V. I. Moroz, A. Rodin, B. Sandel and A. Stern (2004), SPICAM: Studying the Global Structure and Composition of the Martian Atmosphere, in SP-1240 Mars Express: A European Mission to the Red Planet, edited by Wilson, A., pp. 95-120, ESA Publications Division, Noordwijk, The Netherlands.

Matshvili, N., D. Fussen, F. Vanhellefont, C. Bingen, J. Dodion, F. Montmessin, S. Perrier, E. Dimarellis and J. Bertaux (2007), Martian ice cloud distribution obtained from SPICAM nadir UV measurements, *Journal of Geophysical Research: Planets*, 112(E7), E07004, doi:10.1029/2006JE002827.

Matshvili, N., D. Fussen, F. Vanhellefont, C. Bingen, J. Dodion, F. Montmessin, S. Perrier and J. L. Bertaux (2007), Detection of Martian dust clouds by SPICAM UV nadir measurements during the October 2005 regional dust storm, *Advances in Space Research*, 40(6), 869-880, doi:10.1016/j.asr.2007.06.028.

Matshvili, N., D. Fussen, F. Vanhellefont, C. Bingen, E. Dekemper, N. Loodts and C. Tetard (2009), Water ice clouds in the Martian atmosphere: Two Martian years of SPICAM nadir UV measurements, *Planetary and Space Science*, 57(8), 1022-1031, doi:10.1016/j.pss.2008.10.007.

Water cloud optical depth distributions were obtained during different seasons. Knowledge of the cloud optical depths allows the determination of the water content in the clouds which is very helpful for the better understanding of the Martian water cycle and climate. Figure on the left shows the zonally averaged cloud optical depth distribution depending on geographical latitude and Martian seasons (solar longitude), from the beginning of the northern spring to the end of the northern winter. Each season lasts 90° of solar longitude.

SPICAM data gave an opportunity to improve our knowledge of the Martian dust optical properties in the UV domain. Analysis of the SPICAM nadir spectra acquired during a few dust storms allowed to estimate optical properties of the Martian dust, such as single scattering albedo and asymmetry factor, which define how the particles scatter light. Contrary to the visible wavelengths, where the dust clouds are seen as bright features and can even be confused with water ice clouds, in the UV dust clouds are seen as dark spots, i.e. they are strongly absorptive. Knowledge about dust optical properties in the UV is important for modelling how much of the incoming solar UV radiation reaches the surface. Astrobiologists use such calculations to estimate the probability of different microorganisms to survive on Mars.

VENUS ATMOSPHERE EXPLORATION WITH VENUS EXPRESS

Ann Carine Vandaele and Eddy Neefs

With contributions from Arnaud Mahieu, Séverine Robert, Rachel Drummond and Valérie Wilquet

After the success of the Mars Express mission, ESA wanted to benefit from the momentum created by its preparation. They immediately started preparing the next mission, this time towards Venus, called Venus Express. To save money and time, spacecraft and instruments design from older missions would be used, e.g. the UV and IR atmospheric spectrometer "Spectroscopy for Investigation of Characteristics of the Atmosphere of Venus". (SPICAV) was developed from its older sister, SPICAM. BIRA-IASB did, however, propose a very new instrument concept, based on the joint use of an echelle grating and an acousto-optical tunable filter (AOTF) for the selection of the recorded spectral range. The design was accepted by ESA and the "Solar Occultation in the IR" (SOIR) experiment was born and added on the structure of SPICAV. The complete spacecraft and payload had to be ready within 4 years, which is a very short time period to build such a complex assembly.

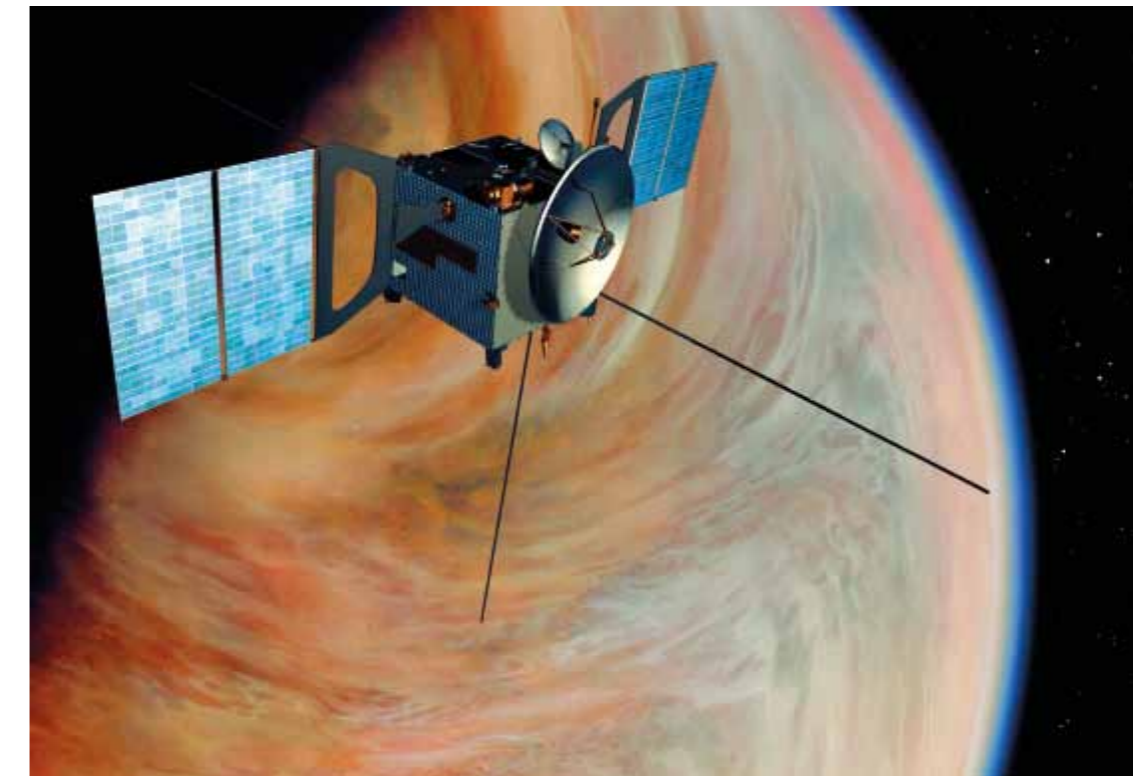

Artist view of Venus Express orbit injection. (credit: ESA)

Venus Express ESA Mission

Venus Express is a copy of the Mars Express spacecraft, adapted for its new environment (closer to the Sun). The word "express" in the names of the Mars Express and Venus Express missions points to the fact that they were processed very rapidly by ESA. For Venus Express, spare models of instruments were used from previous mission Mars Express or Rosetta. Venus Express was launched in November 2005 and inserted into orbit around Venus in April 2006. At the time of writing, it is still delivering high-quality data.

Artist view of Venus Express Spacecraft (credit: ESA)

SOIR barely made it, having sustained some damage during vibration testing which meant parts were replaced by their spares in the flight model. It was therefore a real surprise for our engineers when SOIR responded at its activation close to arrival at Venus. In fact, SOIR has even proven to be one of the more reliable instruments on board Venus Express and is still “alive and kicking”.

Venus is a very warm and dry planet with a dense atmosphere composed mainly of carbon dioxide (CO₂, 96.5%) and nitrogen (N₂, 3.5%). Chemically active species, such as sulfuric bearing gases (OCS, SO₂) and halides (HCl, HF) had already been reported, but since measurements had been performed essentially in the mesosphere below 100 km and below the clouds, information about minor atmospheric constituents, their concentration, reactions, sources and sinks was incomplete. Only scarce measurements had been performed previously above 100 km altitude. SOIR is the only instrument on board Venus Express which can contribute to the study of this region.

The SOIR instrument during integration. (credit: ESA)



SOIR performs solar occultation measurements in the IR region (2.2 – 4.3 μm) at a high spectral resolution (0.15 cm⁻¹), better than all previously flown planetary spectrometers. The solar occultation technique allows to derive unique information about the vertical structure and composition of the Venus mesosphere. The wavelength range probed allows a detailed chemical inventory of the Venus atmosphere above the cloud layer, with an emphasis on the vertical distribution of the gases. Most of the SOIR measurements occur at high northern latitude, because of the shape of the orbit with its pericenter located at about 250 km above the Northern pole and its apocenter at about 65,000 km.

SOIR has been able to detect a series of trace gases such as HCl, HF, H₂O/HDO, CO, and even SO₂. Moreover, absorption bands of CO₂ are present throughout the spectral domain covered by SOIR, with intensities varying over a wide range of values. Combining different spectral intervals in which the CO₂ line strengths differ widely, the CO₂ vertical profile can be obtained from lower altitudes around 65 km to higher altitudes of about 170 km. The hydrostatic equilibrium equation is applied on the retrieved CO₂ density profiles to derive the temperature. These temperature profiles show a permanent cold layer at all latitudes at the altitude of the mesopause (120-130 km), with temperatures below 100 K. This cold layer is surrounded by two warmer layers, at 100 and 140 km. Such a structure was never observed before, nor predicted by any model.

SOIR observations can also provide information on the aerosols present in the atmosphere of Venus. It is well known that the planet is completely enshrouded in a global cloud system located at altitudes comprised between 50 and 70 km. Different kinds of particles can be found in those clouds. SOIR is particularly designed to derive aerosols characteristics (extinction, loading and size) above 70 km.



Venus Atmosphere. (Artist view, credit ESA)

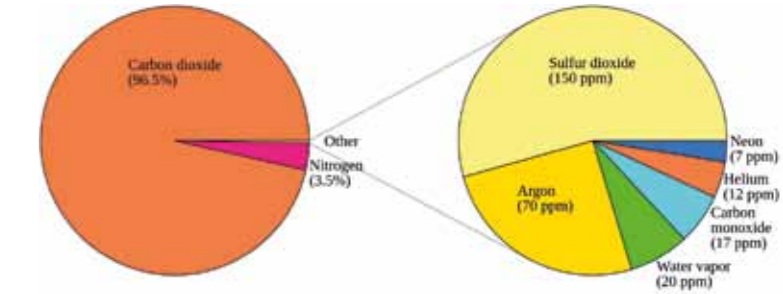

Venus Atmospheric Composition

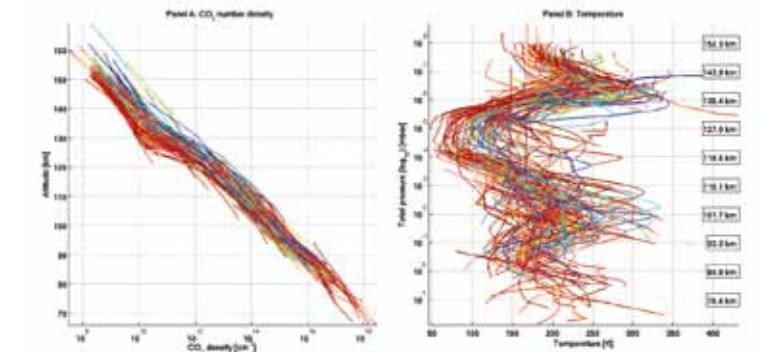

Examples of CO₂ density profiles (left) and CO₂ temperature profiles (right). The inset panel gives the measurement latitude and the orbit number. The density profiles are given as a function of the altitude, and the temperature profiles as a function of the partial pressure, with the altitude given on the right side as an indication. The color is the absolute latitude. High latitude measurements are reddish, while equatorial are bluish. The black lines are the density and temperature profiles as predicted by the current Venus atmosphere models.

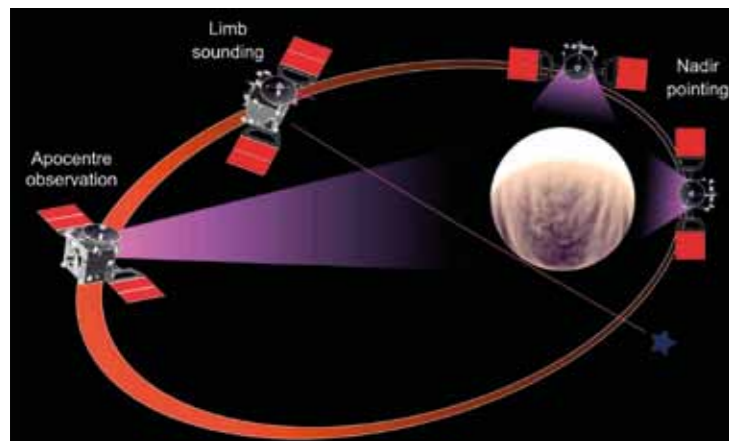

Observing modes. (credit: ESA)

Structure of Venus' Atmosphere

The different layers in an atmosphere are defined based on the temperature evolution within the atmosphere. Contrary to Earth, there is no stratosphere on Venus: following a troposphere which extends up to 70 km, which corresponds to the cloud deck, the mesosphere starts extending into the thermosphere.

SOIR is still delivering quite an impressive quantity of data and will continue to do so until the end of the Venus Express mission. Only a small percentage of these data have been analyzed to date and we can be sure that the instrument still has a lot of discoveries to reveal.

Selected References

Bertaux, J., D. Nevejans, O. Korablev, E. Villard, E. Quémerais, E. Neefs, F. Montmessin, F. Leblanc, J. P. Dubois, E. Dimarellis, A. Hauchecorne, F. Lefèvre, P. Rannou, J. Y. Chaufray, M. Cabane, G. Cernogora, G. Souchon, F. Semelin, A. Reberac, E. Van Ransbeek, S. Berkenbosch, R. Clairquin, C. Muller, F. Forget, F. Hourdin, O. Talagrand, A. Rodin, A. Fedorova, A. Stepanov, I. Vinogradov, A. Kiselev, Y. Kalinnikov, G. Durry, B. Sandel, A. Stern and J. C. Gérard (2007), SPICAV on Venus Express: Three spectrometers to study the global structure and composition of the Venus atmosphere, *Planetary Space Science*, 55(12), 1673-1700, doi:10.1016/j.pss.2007.01.016.

Mahieux, A., A. C. Vandaele, S. Robert, V. Wilquet, R. Drummond, F. Montmessin and J. L. Bertaux (2012), Densities and temperatures in the Venus mesosphere and lower thermosphere retrieved from SOIR on board Venus Express: Carbon dioxide measurements at the Venus terminator, *Journal of Geophysical Research: Planets*, 117(E7), E07001, doi:10.1029/2012JE004058.

Nevejans, D., E. Neefs, E. Van Ransbeeck, S. Berkenbosch, R. Clairquin, L. De Vos, W. Moelans, S. Glorieux, A. Baeke, O. Korablev, I. Vinogradov, Y. Kalinnikov, B. Bach, J. Dubois and E. Villard (2006), Compact high-resolution spaceborne echelle grating spectrometer with acousto-optical tunable filter based order sorting for the infrared domain from 2.2 to 4.3 micrometre, *Applied Optics*, 45(21), 5191-5206, doi:10.1364/AO.45.005191.

Vandaele, A. C., M. De Mazière, R. Drummond, A. Mahieux, E. Neefs, V. Wilquet, O. Korablev, A. Fedorova, D. Belyaev, F. Montmessin and J.-L. Bertaux (2008), Composition of the Venus mesosphere measured by Solar Occultation at Infrared on board Venus Express, *Journal of Geophysical Research: Planets*, 113(E5), E00B23, doi:10.1029/2008JE003140.

NADIR AND OCCULTATION OBSERVATIONS FOR MARS' ATMOSPHERE

Ann Carine Vandaele and Eddy Neefs

With contributions from Rachel Drummond and Frank Daerden

After the success of the SOIR instrument on board the ESA Venus Express mission, BIRA-IASB started to propose the concept of such instruments for other planetary missions. A similar instrument was part of the payload of the NASA Scout mission called The Great Escape (TGE), which was set up by the Southwest Research Institute (Principal Investigator : James Burch). SOIR-TGE was one of the nine instruments of the mission whose main objective was to characterize the Martian atmospheric escape processes. The responsibility of providing the instrument was shared by BIRA-IASB and LATMOS (F. Montmessin). In the end, SOIR-TGE was not selected by NASA, even though it already passed the Mission Analysis Phase. Instead, its competitor, MAVEN, was launched and is now on its way to the Red Planet.

Shortly after, NOMAD, the "Nadir and Occultation for Mars Discovery" spectrometer suite was selected by ESA and NASA to be part of the payload of the ExoMars Trace Gas Orbiter (TGO) mission 2016. ExoMars is a twofold mission: a first element (TGO, along with an Entry, Descent and Landing Demonstrator Module (EDM)) will be launched in 2016, while a second element based on a landing platform and a rover will follow in 2018. The ExoMars program itself has undergone a series of modifications since its launch. Initially a combined mission of ESA and NASA, it is now a collaboration between ESA and ROSCOSMOS, the Russian Space Agency. The latter will provide the launcher, as well as scientific instruments to replace the US ones initially selected to be part of the ExoMars mission.

NOMAD will search for active geology, volcanism and life by looking for their atmospheric markers. NOMAD will confine potential source regions and provide crucial information on the nature of the processes involved. NOMAD will also extend the survey of the major climatologic cycles of Mars such as the water, carbon and ozone cycles, and provide information on their different components, including isotopic fractionation and atmospheric escape processes.

NOMAD is composed of 3 channels: a solar occultation only channel (SO) operating in the infrared wavelength domain, a second infrared channel capable of doing nadir, but also solar occultation and limb observations (LNO), and an ultraviolet/visible channel (UVIS) that can work in all observation modes. The spectral resolution of SO and LNO surpasses previous surveys in the infrared by more than one order of magnitude. The three channels each have their own Instrument Line of Sight and optical bench, but share the same single interface to the spacecraft. This instrument suite will conduct a spectroscopic survey of the Martian atmosphere in the UV, visible and IR regions covering the 0.2-0.65 μm and 2.2-4.3 μm spectral ranges.

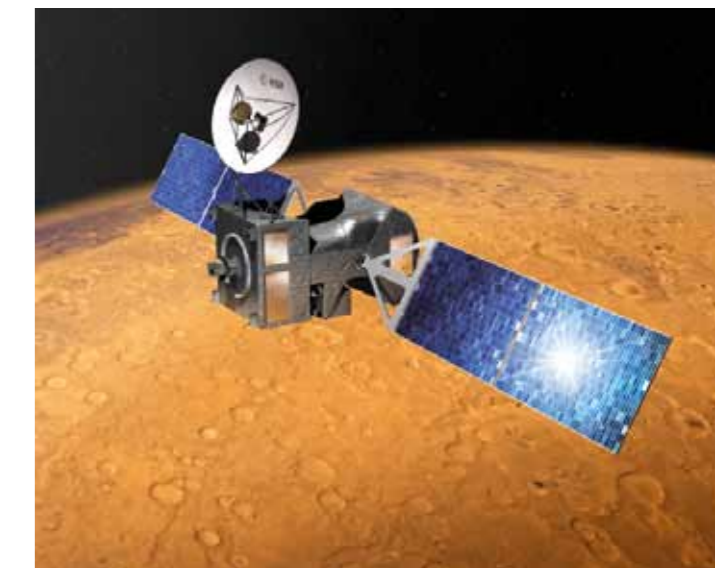

Artist's view of ExoMars Trace Gas Orbiter. (credit: ESA)

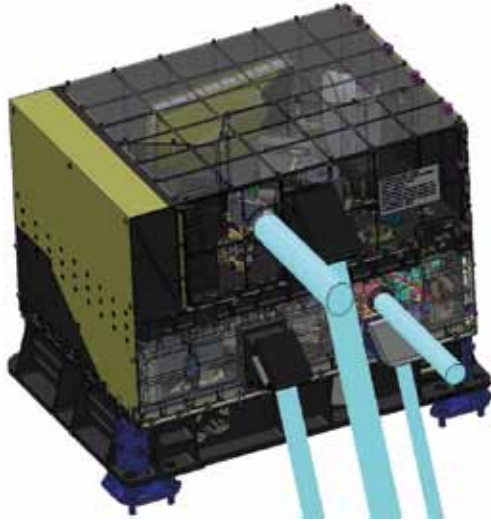

Schematic representation of NOMAD.

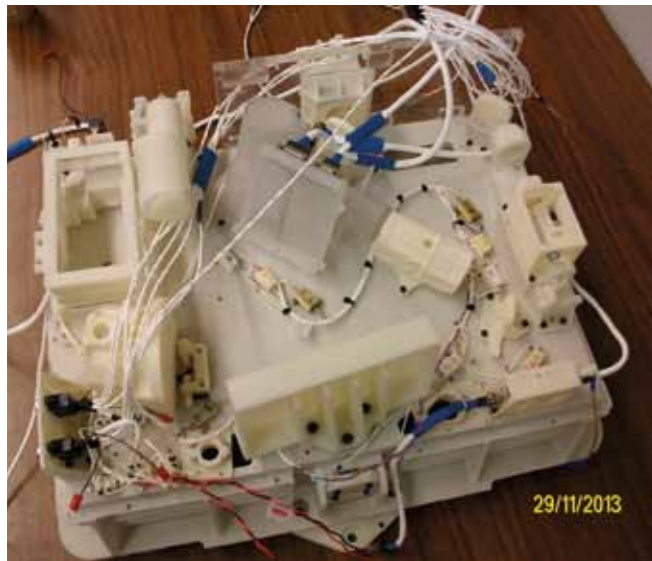

NOMAD's mock up of the channels, obtained with a 3D printer. This printout serves as a basis to design the harnessing of NOMAD. There is a real 'spaghetti' of wires criss-crossing the instrument, colour coded and of varying thicknesses. The heater loops are attached tightly to the baseplate, and have redundant heaters in case any fail.

NOMAD offers an integrated instrument combination of a flight-proven concept (SO is a copy of SOIR on Venus Express), and innovations based on existing and proven instrumentation (LNO is based on SOIR/VEX and UVIS has heritage from the ExoMars lander), that will provide mapping and vertical profile information at high spatio-temporal resolution.

NOMAD permits the full exploitation of the orbit. From a 74° inclined orbit, the latitudes covered in solar occultation range from 87°N to 88°S with good revisit time at various solar longitudes. The nadir coverage between ±74° latitude provides global spatial sampling on average every 3 to 4 sols with varying local times. Due to the nature of the orbit, there will be occasional repeated ground tracks offering better temporal sampling of a given region.

NOMAD is the result of the collaboration between Belgian and other European partners. In Belgium, IASB-BIRA leads the team and provided the Principal Investigator, Project Scientist, Project Manager and a strong team of dedicated scientists and engineers. Other Belgian contributions to this project come from the Centre Spatial de Liège (CSL), the Royal Observatory of Belgium and the University of Liège. European partners are from Italy, Spain and the United Kingdom. Initially Spain, the second most important contributor after Belgium, was concerned with all the electronics, from design to building; Italy was involved in the design and procurement of all periscopes; and UK was designing and providing the UVIS channel. However, due to the economic situation in Europe, the contribution from the international partners dwindled and most of their activities were taken over by Belgium. Today, almost all activities, except some design work still in UK and Spain, are performed by Belgian scientists, engineers and industry. OIP (Oudenaarde) is the prime contractor of the instrument, responsible for the building of the SO and LNO channels, as well as of the final integration of all subassemblies and of the instrument on the spacecraft. LambdaX (Nivelles) is procuring the UVIS channel optics, Thales Alenia Space (Charleroi) all the electronics, and AMOS (Liège) some optical components.

Selected References

Daerden, F., A. C. Vandaele, J. J. Lopez-Moreno, R. Drummond, M. R. Patel, G. Bellucci and the NOMAD team (2011), Science objectives of the NOMAD spectrometer on ExoMars Trace Gas Orbiter, EPSC Abstracts, 6, EPSC-DPS2011-1300-1.

Drummond, R., A.-C. Vandaele, F. Daerden, D. Fussen, A. Mahieux, L. Neary, E. Neefs, S. Robert, Y. Willame and V. Wilquet (2011), Studying methane and other trace species in the Mars atmosphere using a SOIR instrument, Planetary and Space Science, 59(2-3), 292-298, doi:10.1016/j.pss.2010.05.009.

Mahieux, A., V. Wilquet, R. Drummond, D. Belyaev, A. Federova and A. C. Vandaele (2009), A new method for determining the transfer function of an Acousto optical tunable filter, Optics Express 17(3), 2005-2014, doi:10.1364/OE.17.002005.

Vandaele, A. C., F. Daerden, R. Drummond, E. Neefs, J.-J. López-Moreno, J. Rodríguez Gomez, M. R. Patel, G. Bellucci and the NOMAD team (2011), NOMAD, a spectrometer suite for Nadir and Solar Occultation observations on the ExoMars Trace Gas Orbiter, paper presented at The Fourth International Workshop on the Mars Atmosphere: Modelling and Observation, February 8-11 2011, Paris, France.

REMOTE SENSING OF AEROSOLS ON MARS AND VENUS

Valérie Wilquet

With contributions from Yannick Willame

Global monitoring of aerosols in planetary atmospheres can be carried out by nadir observations of backscattered or reflected light. It gives a good perception of how the aerosol abundance in the atmosphere varies with time and space. The vertical distribution of aerosols is based upon the measurement of extinction (absorption + scattering) of a light source (usually the Sun) by atmospheric species and present along the optical path during occultation measurements. Compared to limb or nadir observations of reflected sunlight, occultation only depends on the ability of atmospheric species to scatter light in the forward direction. Therefore, occultation data can lead to consistent estimates of particle sizes of aerosols as spectral variation of the extinction weakly depends on the shape of aerosols.

If aerosol composition is not well known, it is difficult to obtain useful information on the shape of particles. The best way is to sample the scattering phase functions using Emission Phase Function (EPFs) from an orbiter. EPF is a practical tool to study aerosol properties consisting in looking at the same point on the planet while the satellite moves along its orbit.

Mars

Dust aerosols are always present in the Martian atmosphere. Their presence significantly affects the thermal structure of the atmosphere and is a major driver of atmospheric circulations at all spatial scales. Dust in suspension is overall the largest and most permanent source of diabatic heating since it absorbs solar radiation at blue wavelengths and heats the atmosphere.

The importance of aerosols in the Martian atmosphere and climate through solar absorption and thermal emission was recognized even prior to the arrival of Mariner 9 at Mars (a NASA mission launched in 1971). Observations of dust aerosols at high altitudes (above 60 km) can be associated with planet-encircling dust events and require large vertical advective velocities to lift dust particles up to such low pressure levels.

As mentioned in section "Mars Express" chapter 13, the SPICAM instrument on board Mars Express, partly developed at BIRA-IASB, gives invaluable information on the vertical distribution of dust in solar occultation geometry. These observations show detached layers of water ice clouds superimposed on the background dust haze layer. The depth of this haze layer shows dust extending high in the atmosphere during dusty times and confined near the surface and near the poles during the clear season.

SPICAM data in the nadir geometry allowed to improve our knowledge about the Martian dust optical



Dust storm on Mars.

properties in the UV domain since dust clouds show strong absorption and scattering effects in the UV. Indeed the analysis of SPICAM UV data revealed the ability of this instrument to detect dust storm events and to derive some constraints on the dust optical parameters. The Martian water ice cloud optical depth distribution, related to the atmospheric circulation and important in understanding the Martian water cycle, was also obtained from nadir measurements of the SPICAM UV spectrometer. Current efforts aim at characterizing Martian aerosol properties from EPF measurements of the SPICAM UV instrument.

Venus

Venus is completely enshrouded in clouds which show an enormous vertical extent of more than 50 km. These clouds are mainly found in a permanent cloud deck located between 45 and 70 km of altitude, with thin hazes above and below. They are mostly composed of sulfuric acid (H₂SO₄) aerosol particles. The Pioneer Venus, a NASA mission launched in 1978, has shown that the upper haze (70–90 km), above the clouds layer, is composed of submicron aerosol particles with an effective radius below 0.3 μm and compatible with a haze consisting of concentrated sulfuric acid (75%).

The SPICAV instrument on board Venus Express is composed of three independent spectrometers: the UV and IR spectrometers and the SOIR instrument, built at BIRA-IASB. SOIR performs solar occultation observations in the IR and therefore allows characterization of the terminator (day-to-night limit), an up-to-now uncharted region of the Venus' atmosphere. As mentioned previously, one of the main advantages of the solar occultation technique is the high vertical resolution and in comparison with nadir viewing, a much longer optical path resulting in an improved sensitivity.

Selected References

Willame, Y., A. C. Vandaele, C. Depiesse, D. Gillotay, S. Kochenova and F. Montmessin (2013), Preliminary results of aerosols' properties studied with EPF measurements from the SPICAM/UV instrument, paper presented at EGU General Assembly, 07-12 April 2013, Vienna, Austria.

Wilquet, V., A. Fedorova, F. Montmessin, R. Drummond, A. Mahieux, A. C. Vandaele, E. Villard, O. Korabiev and J.-L. Bertaux (2009), Preliminary characterization of the upper haze by SPICAV/SOIR solar occultation in UV to mid-IR onboard Venus Express, *Journal of Geophysical Research: Planets*, 114(E9), E00B42, doi:10.1029/2008JE003186.

Wilquet, V., R. Drummond, A. Mahieux, S. Robert, A. C. Vandaele and J. Bertaux (2012), Optical extinction due to aerosols in the upper haze of Venus: Four years of SOIR/VEX observations from 2006 to 2010, *Icarus*, 217(2), 875-881, doi:10.1016/j.icarus.2011.11.002.

The ability of the SPICAV/SOIR instrument to perform simultaneous solar occultations with the three channels allows making use of the full spectral range of the instrument, from 170 nm up to 4 μm and taking maximum advantage of the spectral dependence of the solar light extinction due to aerosols. A preliminary study of SPICAV/SOIR spectra demonstrated, for the first time above 70 km, the existence of particles with a radius varying between ~0.4 and 1 μm depending on the altitude in addition to the smaller particles with radii comprised between ~0.1 and 0.3 μm.

From previous missions to Venus, data on the climatology of the upper haze of Venus are rather sparse. Four years of vertical profiles of light extinction by aerosols in the Venus upper haze, from SOIR observations covering the whole latitude range, showed that there is high short-term (a few Earth days) and long-term (~80 Earth days) variability and a clear structure in the latitudinal distribution of the aerosol loading. The extinction at a given altitude within the upper haze is higher by at least a factor of 10 for observations near the equator compared to those at the poles, in agreement with the fact that SO₂ photolysis is more efficient at low latitudes, a reaction involved in aerosol formation on Venus.

MODELLING OF PLANETARY ATMOSPHERES

Frank Daerden With contributions from Lori Neary

The focus of the modelling work for (neutral) planetary atmospheres at BIRA-IASB has been on the atmosphere of Mars. In recent years two models for Mars have been developed based on models for the Earth.

Snow on Mars: Developing a Cloud Model for Mars

On 25 May 2008 the Phoenix mission landed successfully on Mars with on board a Canadian LIDAR instrument, the first in its kind to operate on another planet. One of its most extraordinary discoveries was the detection of active precipitation, often referred to as "snow on Mars". Simple radiative model calculations showed that the precipitating particles consisted of water ice and that their size is necessarily very large, up to tens of microns, which is an order of magnitude larger than any particle detected on Mars before.

We worked with Jim Whiteway of York University (Toronto, Canada), Principal Investigator of the LIDAR instrument, to understand this precipitation and its impact on the environment. We developed a microphysical cloud model for Mars and coupled this to a detailed radiative model of dust in the Planetary Boundary Layer (PBL). This 1-dimensional cloud model described the nucleation of ice particles on a background of dust particles of various sizes and the subsequent deposition and sublimation of water vapour on and from the ice particles. The model includes many detailed microphysical processes and takes into account particle shape. For comparisons with the LIDAR measurements, specific optical routines (T-matrix) are included.

The simulations confirmed the formation of boundary layer clouds and very large ice particles which sediment at high speed. The precipitating particles have sizes up to 50 μm effective radius which corresponds to ice crystals of length 150 μm. This is comparable to the crystals in terrestrial cirrus clouds, which are formed under similar conditions of temperature, pressure and humidity as the Mars boundary layer clouds. The simulated number densities are of the order of 0.01 particle per cm³, which is comparable to the terrestrial phenomenon of "diamond dust". The cloud model also supported other studies for the interpretation of Phoenix measurements.

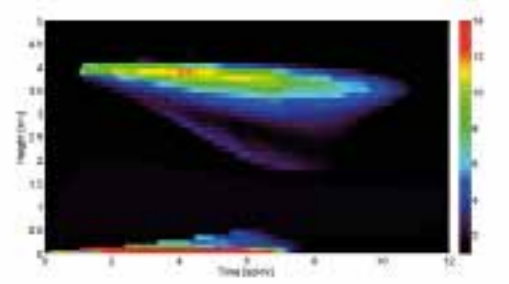
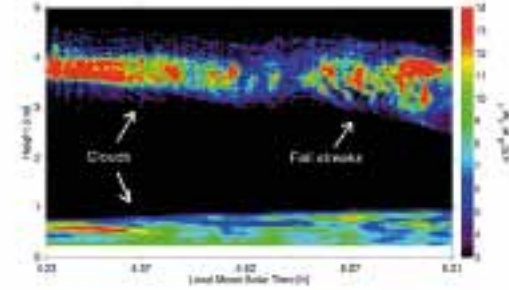

Top: Phoenix LIDAR measurements of backscatter at 532 nm in the morning.
Bottom: Simulation of this backscatter at 532 nm by the BIRA-IASB Mars cloud model from midnight to noon local time. The fall streak is simulated and reaches down to 2.5 km at 5h local time, consistent with the observed fall streaks. (from Daerden et al. 2010).

Diamond Dust:

Also known as "clear-sky precipitation". This is a phenomenon observed at the Polar Regions on Earth, where atmospheric water vapour condenses into ice which then precipitates, however at very low number densities such that the global visibility is not reduced. The background sky remains blue while ice particles fall from the sky.

Planetary Boundary Layer (PBL):

This is the lowest atmospheric layer where the atmosphere is in contact with the surface and where strong convective processes take place during the day. On Mars the PBL can reach depths of 5 to 10 km, much deeper than on Earth.

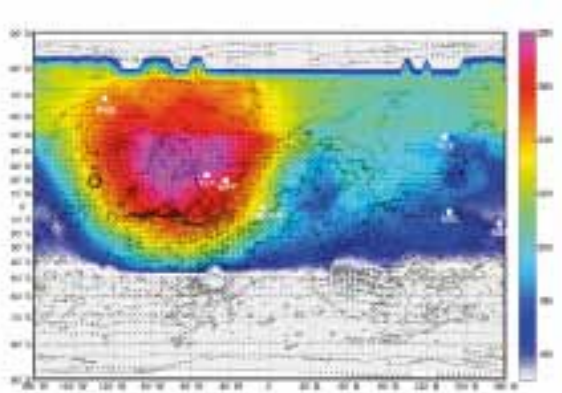

Map of the surface temperature on Mars as simulated in GEM-Mars, around northern summer solstice. The grey areas are the seasonal polar caps, where the soil is covered by CO₂ ice. Near-surface wind fields are indicated by the small arrows. The sites of successful Mars landers are indicated.

The Phoenix Lander and LIDAR: Phoenix was a mission in the NASA Scout program, led by the University of Arizona. It landed successfully on Mars on 25 May 2008 and remained operational until 2 November 2008. It was the first lander in the polar region of Mars. Phoenix carried a Light Detection and Ranging (LIDAR) instrument developed in Canada for the detailed analysis of the physical composition of the lower atmosphere.

GCM for Mars: General Circulation Models (or Global Climate Models) are numerical computer models in which the atmosphere is represented by a large three-dimensional grid structure and in which the general circulation as well as other atmospheric processes can be simulated, to understand weather, climate, and atmospheric composition.

Mars Global Atmospheric Modelling

Around 1990 a two-dimensional model was developed at BIRA-IASB, the first in its kind for Mars. This model comprised 19 of the most important chemical species. The model was successful at its time, but with the increase in computational capacities, 3-dimensional general circulation models (GCMs) could be developed for Mars since the mid-1990s. In 2006 BIRA-IASB started to work with John C. (Jack) McConnell of York University who had recently supervised the development of the Global Mars Multiscale Model (GM3). This model was built on the framework of the Global Environmental Multiscale Model (GEM) applied for terrestrial weather prediction by the Meteorological Service of Canada. BIRA-IASB continued to refine this model and it was renamed into GEM-Mars: the “Global Environmental Multiscale model for Mars”. GEM-Mars is a grid-point model extending from the surface to 150 km, with Mars atmospheric physics replacing the terrestrial physics. This comprises radiative transfer through an atmosphere of CO₂ and dust. Dust is the dominant thermal agent in the lower atmosphere. Recently active dust processes were implemented in GEM-Mars in which dust is lifted by strong near-surface winds as well as in dust devils.

GEM-Mars simulates the annual formation of the polar caps on Mars and its effect on the atmospheric pressure. The model also contains routines for heat transfer in the soil (including a subsurface ice table), a treatment of the atmospheric surface layer and of the turbulent planetary boundary layer, the water cycle (including water vapour, clouds and frost), and atmospheric chemistry. We recently started detailed validation of the simulations for ozone, oxygen airglow and carbon monoxide. GEM-Mars will be applied to support the Nadir and Occultation for MArS Discovery (NOMAD) instrument on the ExoMars Trace Gas Orbiter (TGO) (see section “NOMAD”, chapter 13).

Selected References

Daerden, F., J. A. Whiteway, R. Davy, C. Verhoeven, L. Komguem, C. Dickinson, P. A. Taylor and N. Larsen (2010), Simulating observed boundary layer clouds on Mars, *Geophysical Research Letters*, 37(4), L04203, doi:10.1029/2009GL041523.

Moores, J. E., L. Komguem, J. A. Whiteway, M. T. Lemmon, C. Dickinson and F. Daerden (2011), Observations of near-surface fog at the Phoenix Mars landing site, *Geophysical Research Letters*, 38(4), L04203, doi:10.1029/2010GL046315.

Moreau, D., L. W. Esposito and G. Brasseur (1991), The chemical composition of the dust-free Martian atmosphere: Preliminary results of a two-dimensional model, *Journal of Geophysical Research: Solid Earth*, 96(B5), 7933-7945, doi:10.1029/90JB02544.

Whiteway, J. A., L. Komguem, C. Dickinson, C. Cook, M. Illnicki, J. Seabrook, V. Popovici, T. J. Duck, R. Davy, P. A. Taylor, J. Pathak, D. Fisher, A. I. Carswell, M. Daly, V. Hipkin, A. P. Zent, M. H. Hecht, S. E. Wood, L. K. Tamppari, N. Renno, J. E. Moores, M. T. Lemmon, F. Daerden and P. H. Smith (2009), Mars Water- Ice Clouds and Precipitation, *Science*, 325(5936), 68-70, doi:10.1126/science.1172344.

Zurek, R. W., A. Chicarro, M. A. Allen, J. Bertaux, R. T. Clancy, F. Daerden, V. Formisano, J. B. Garvin, G. Neukum and M. D. Smith (2011), Assessment of a 2016 mission concept: The search for trace gases in the atmosphere of Mars, *Planetary Space Science*, 59(2), 284-291, doi:10.1016/j.pss.2010.07.007.

MASS SPECTROMETRY ON ROSETTA

Johan De Keyser and Frederik Dhooghe
With contributions from Herbert Gunell

In the course of the work with mass spectrometers on stratospheric balloons, a collaboration started between Ernest Kopp of the Physikalisches Institut of the Universität Bern and the BIRA-IASB mass spectrometry team under Etienne Arijs. As a consequence, the Institute was invited to participate in the construction of a mass spectrometer that would fly on Rosetta, ESA’s comet rendez-vous mission. The team in Bern had a particular interest in comets as they had been responsible for the Giotto neutral and ion mass spectrometers under the leadership of Hans Balsiger and Peter Eberhardt. The BIRA-IASB mass spectrometry team, together with the engineering team under Dennis Nevejans, contributed to the detector electronics of the Double Focusing Mass Spectrometer (DFMS), a high-resolution mass spectrometer. DFMS is part of the ROSINA instrument package on Rosetta. DFMS has three detectors: a Linear Electron Detector Array (LEDA, built by BIRA-IASB and the Belgian IMEC industry), a channeltron, and a Faraday Cup. A prototype, an engineering model, and 2 flight models have been built. While one of the flight models has been mounted on Rosetta, the other one resides in the CASYMIIR test facility in Bern for calibration purposes. BIRA-IASB was responsible for performing low-temperature tests to assess the operating limits of the instrument in deep space. Additionally, a lot of effort has gone into the development of software for the data calibration.

The Rosetta mission consists of an Orbiter and a Lander (Philae). The spacecraft was launched on 2 March 2004 from Kourou (French Guyana) with an Ariane rocket. In order to make a rendez-vous with a comet on its journey toward the Sun, Rosetta entered into an orbit with an aphelion of around 5 AU (Astronomical Units). This requires a large change in velocity, which was achieved by gravity-assisted fly-by’s of Earth in 2005, 2007 and 2009, and of Mars in 2007. Since Europe does not possess plutonium-based Radioisotope Thermal Generator technology, the only way to provide sufficient power was to equip Rosetta with huge solar panels (32 metres tip to tip).

On its way Rosetta encountered the two interesting asteroids Šteins (2008) and Lutetia (2010). Rosetta’s target comet originally was 46P/Wirtanen, but due to a launch delay another target had to be chosen: 67P/Churyumov-Gerasimenko. Rosetta started its approach of the comet with a maneuver in May 2014 to get up close from August onwards. The comet will reach its closest approach to the Sun in August 2015. During the mission, the Rosetta Orbiter will explore the environment of the comet, including the *bow shock*, the *comet sheath* and *cometopause* where the interaction between the comet and the solar wind takes place, and it will also spend considerable time in the cometary coma with some passes down to about 1 km from the nucleus. Early in the mission, when the comet is still not very actively producing dust, the Philae lander will touch down on the nucleus. The lander will provide “ground truth” measurements about the nucleus.



The DFMS instrument on board Rosetta, a mass spectrometer with high mass resolution. BIRA-IASB contributed to the LEDA detector and the electronics.



The ESA mission to the Churyumov-Gerasimenko's comet was named after the "Rosetta Stone". This slab of volcanic basalt – now in the British Museum in London – was the key to unravelling the civilisation ancient Egypt. It was discovered in 1799, in Egypt's Nile delta. The carved inscriptions on the Stone included hieroglyphics and Greek. Jean-François Champollion (1790-1832) published the first translation of the Rosetta stone hieroglyphs in 1822. (After ESA)

The quality of the DFMS instrument on board has already been demonstrated by its ability to measure the flux and composition of the spacecraft outgassing. This includes fragmentation products of the hydrazine propellant, water, decay products of lubricants, etc. It is important to characterise this outgassing environment in order to be able to distinguish it from comet material, especially during early comet operations.

The BIRA-IASB team aims at understanding the coma chemistry. In particular, one of the goals is to be able to estimate the source production rate and the source composition at the nucleus surface from coma measurements by DFMS at a distance. This is an inverse problem that requires a sufficiently detailed knowledge of the chemistry and photochemistry in the coma, since the volatiles escaping from the comet nucleus undergo photodissociation and the products may further react. If measurements are obtained sufficiently close to the nucleus, so that diffusion across streamlines does not matter, this technique can be used to assess the outgassing inhomogeneity, both in terms of gas production rate and in terms of composition. A related research objective is the study of the dust and ice grains released from the nucleus; volatile gas escape from such grains may constitute a so-called "extended source" of coma material.

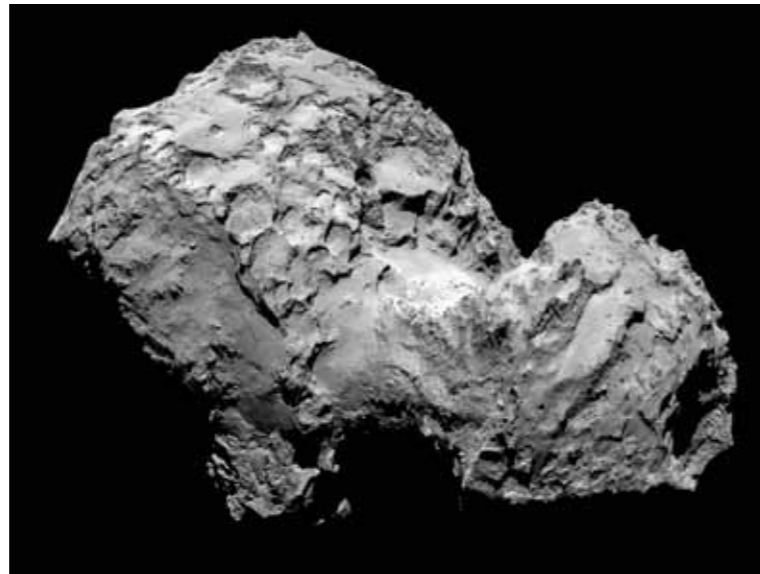

Comet 67P/Churyumov-Gerasimenko by Rosetta's OSIRIS narrow-angle camera on 3 August 2014 from a distance of 285 km. The image resolution is 5.3 metres/pixel. (credit: ESA/Rosetta/MPS)

Selected References

Altwegg, K., H. Balsiger, U. Calmonte, M. Hässig, L. Hofer, A. Jäckel, B. Schläppi, P. Würz, J. J. Berthelier, J. De Keyser, B. Fiethe, S. Fuselier, U. Mall, H. Rème and M. Rubin (2012), In situ mass spectrometry during the Lutetia flyby, *Planetary Space Science*, 66(1), 173-178, doi:10.1016/j.pss.2011.08.011.

Balsiger, H., K. Altwegg, P. Bochsler, P. Eberhardt, J. Fischer, S. Graf, A. Jäckel, E. Kopp, U. Langer, M. Mildner, J. Müller, T. Riesen, M. Rubin, S. Scherer, P. Würz, S. Wüthrich, E. Arijs, S. Delanoye, J. Keyser, E. Neefs, D. Nevejans, H. Rème, C. Aoustin, C. Mazelle, J.-L. Médale, J. Sauvaud, J.-J. Berthelier, J.-L. Bertaux, L. Duvet, J.-M. Illiano, S. Fuselier, A. Ghielmetti, T. Magoncelli, E. Shelley, A. Korth, K. Heerlein, H. Lauche, S. Livi, A. Loose, U. Mall, B. Wilken, F. Gliem, B. Fiethe, T. Gombosi, B. Block, G. Carignan, L. Fisk, J. Waite, D. Young and H. Wollnik (2007), Rosina - Rosetta Orbiter Spectrometer for Ion and Neutral Analysis, *Space Science Reviews*, 128(1), 745-801, doi:10.1007/s11214-006-8335-3.

De Keyser, J. (2012), Er zit een luchtje aan onze satelliet: Over satellietpollutie en gevoelige massaspectrometrie, *Heelal*, 57(6), 188-191.

Delanoye, S. N. and J. De Keyser (2009), Rosetta/ROSINA and Chemistry in a Cometary Coma, in *Deep Impact as a World Observatory Event: Synergies in Space, Time, and Wavelength*, Proceedings of the ESO/VUB Conference held in Brussels, Belgium, 7-10 August 2006, edited by Käufel, H.U. and C. Sterken, pp. 301-305, Springer, Berlin.

Hässig, M., K. Altwegg, H. Balsiger, B. Schläppi, J. J. Berthelier, B. Fiethe, S. A. Fuselier, J. De Keyser and M. Rubin (2011), Investigation of spacecraft outgassing by sensitive mass spectrometry, *Spectroscopy Europe*, 23(2), 20-23.

The solar wind interaction with a comet resembles that of a boat moving across a lake.

Bow Shock

This is the site where the solar wind first notices that there is a comet ahead (apart from the cometary neutrals that may move far upstream in the solar wind and that lead to mass-loading of the solar wind). This is like the bow wave in front of a boat that breaks the unperturbed surface of a lake.

Cometopause

The boundary between the coma (the region close to the comet) that is dominated by neutrals and ions of cometary origin, and the space outside where solar wind ions dominate. Electric currents flow through this boundary surface so as to exclude the interplanetary magnetic field from the diamagnetic cavity within (a region without magnetic field). It keeps solar wind ions out of the cavity, just like the hull of a boat keeps out the water.

Cometosheath

The region between the bow shock and the cometopause, where the solar wind is forced to flow around the comet. This is like the water flowing around the boat's hull.

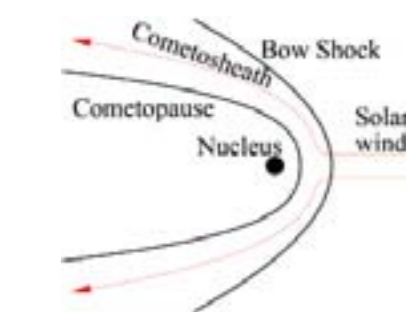

14

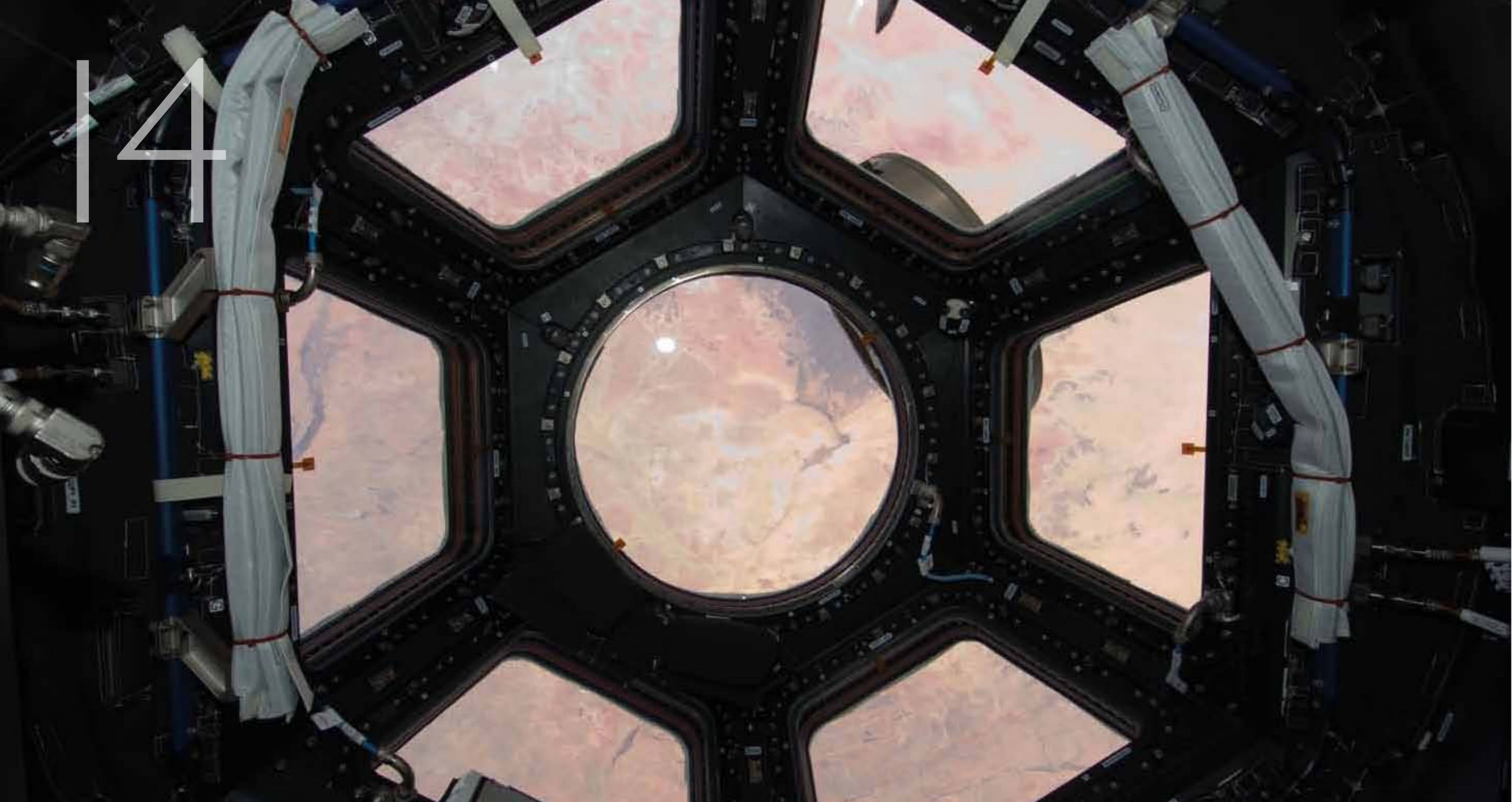

BELGISCH INSTITUUT VOOR RUIMTE-AÉRONOMIE (BIRA) INSTITUT D'AÉRONOMIE SPATIALE DE BELGIQUE (IASB) BELGIAN INSTITUTE FOR SPACE AERONOMY (BIRA-IASB) BELGISCH INSTITUUT VOOR RUIMTE-AÉRONOMIE (BIRA) INSTITUT D'AÉRONOMIE SPATIALE DE BELGIQUE (IASB)

SCIENCE AND APPLICATIONS

Michel Kruglanski



Image taken through the “bay window” on the International Space Station. The image shows the Sahara Desert spread out through the array of windows.

SATELLITE TRAJECTORY FORECASTING

Paul C. Simon

Knowledge of the atmospheric environment where artificial satellites orbit is also of practical interest for predicting the moment of re-entry of a spacecraft subject to atmospheric drag.

Even though the upper atmosphere is extremely rarefied, due to the velocity with which a satellite travels, the collisions with air molecules are frequent enough to create an appreciable drag force. If the orbit is non-circular, the air drag is much greater at perigee than at apogee, the orbit contracts and becomes more nearly circular. If the orbit is initially circular, air drag acts all around the orbit, and its effect is to reduce the height of the satellite gradually, so that the satellite slowly spirals inwards. In this way, satellite drag measurements allow to calculate the atmospheric density at perigee altitudes.

The re-entry of a satellite is sometimes a source of anxiety as was the case, in 1979, for Skylab I (77 tons). The analysis of the evolution of the mean altitude and the daily variation of the revolution period of this satellite showed the influence of the 11-year solar activity cycle.

The knowledge of the physical structure of the Earth’s upper atmosphere i.e. the vertical profiles of density and temperature above 150 km altitude has been largely extended using the techniques of the orbital variations of artificial satellites. In this matter, an analytical theory has been developed to calculate the atmospheric density from the analysis of variations of the orbital period, giving all possible values to the physical parameters of the problem. In particular, this method allowed to determine very accurately the densities in atmospheric regions when the density scale height gradient is important. This method was in particular applied in the mean thermosphere, at a time when data were still scarce in this atmospheric region.

The physical parameters describing the upper atmosphere are subject to different types of variations. These variations, and in particular those which are linked to the geomagnetic and semi-annual effects, were subject to further research. .

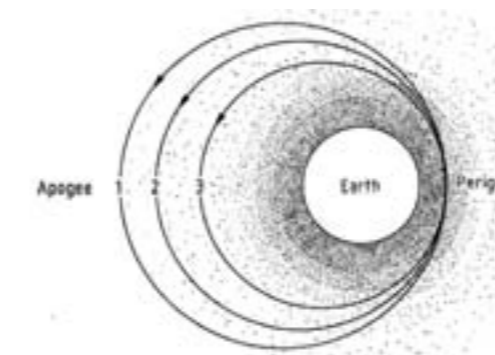

Atmospheric drag leads to apogee lowering, leading for moderately eccentric orbit to the circularisation of the orbit.

Selected References

Vercheval, J. (1974), Contribution à l'étude de l'atmosphère terrestre supérieure à partir de l'analyse orbitale des satellites, Académie Royale de Belgique Classe des Sciences Mémoires Collection in-8°, 2e sér., t. 41, fasc. 6, Académie Royale de Belgique, Brussels.

Vercheval, J. (1975), Un effet géomagnétique dans la thermosphère moyenne, *Annales de Geophysique*, 31(2), 261-270.

Vercheval, J. (1976), Variations of exospheric temperature and atmospheric composition between 150 and 1100 kilometres in relation to the semi-annual effect, In *COSPAR Space Research XVI, Proceedings of the Open Meetings of Working Groups on Physical Sciences of the 18th Plenary Meeting of COSPAR, Varna Bulgaria, 29 May-7 June 1975, and COSPAR Symposium and Workshop on Results from Coordinated Upper Atmosphere Measurement Programs, Varna, Bulgaria, 29-31 May 1975*, edited by Rycroft, M.J., pp. 307-312, Akademie Verlag, Berlin, Germany.

SPACE WEATHER

Michel Kruglanski and Neophytos Messios

The Sun provides the Earth with a quasi-steady source of energy, but, on the other hand, it is also an active star responsible for periodically stormy outbursts causing disturbances in our space environment and on Earth. Some energy outbursts are accompanied by the release of immense clouds of solar material (coronal mass ejections). When directed towards Earth, they can cause large magnetic storms in the magnetosphere and the upper atmosphere.

Space weather can be defined as the conditions on the Sun and in the solar wind, as well as in the Earth's magnetosphere, ionosphere, and thermosphere that can influence the performance and reliability of space-borne but also ground-based technological systems and can endanger human life or health.

The impact of space weather on our society has long been known e.g. disruptions of telegraph systems due to solar storms were seen in the mid-nineteenth century. However, since then, we have greatly increased our sensitivity to space weather as technological systems play a more critical role to the functioning of economies and societies around the globe. As a result, nowadays, numerous sectors are potentially affected by space weather. These include sectors relying on space-based technologies (e.g. broadcasting, weather service, navigation) but also other sectors such as power distribution and resource exploitation, especially when operated at high latitudes. The effects of space weather are observed in the degradation of spacecraft performance, reliability, and lifetime. Space weather amplifies the health risks for astronauts participating in manned space missions. It also affects operation in the aviation sector and influences the radiation doses by the crew. In case of extreme space weather events, the effects on ground can include damage and disruption to power distribution networks, decreased pipeline lifetime and interruption of radio High Frequency communications.

BIRA-IASB's long-term goal regarding space weather is to increase the space weather awareness among the concerned sectors, including industry, policy makers and general public. It is achieved by providing space weather related services built on the scientific and technical expertise of the Institute in the field of the hazardous space environment and its effects.



The Heliophysics System Observatory (HSO) showing current operating missions, missions in development, and missions under study. (credit: NASA)

Space Weather at BIRA-IASB: a Historical Overview

The first space weather related activities at BIRA-IASB are dating back to the mid-1980s. These were focused on the study of the radiative space environment in the framework of ESA projects and targeting mainly the spacecraft designers and operators.

It started with the Institute's participation in the four ESA's TRapped Radiation ENvironment Development (TREND) studies (the three last led by the Institute). The main objective of TREND was to improve the models of the radiation environment used by space engineers to predict the impact of the Van Allen radiation belts on a spacecraft and its components.

The TREND studies identified the limitations of the existing Earth's radiation environment models and demonstrated the need for their continuous update based on regular new in situ measurements. During these studies, the software package UNIRAD used by ESA when preparing space missions (for the estimation of radiation exposure and spacecraft degradation) was improved and extended.

A large effort was also devoted to the development of a comprehensive Fortran subroutine library, called UNILIB, with functionalities related to the calculation of magnetic coordinates, adiabatic invariants, coordinate transformations, field line tracing, mirror point altitudes and magnetic drift shell determination.

The emergence of the World Wide Web led to the development of a SPace ENVIRONMENT Information System (SPENVIS) for ESA under the leadership of the Institute. Operated since 1996, the SPENVIS system provides a world wide access to a large spectrum of models related to the space environment.

In the following years, the concept of space weather became more important in Europe, leading to a rapidly growing space weather community. As part of this evolution, the Institute participated to one of the Space Weather Programme Feasibility Studies initiated by ESA in 1999 and the subsequent Space Weather Applications Pilot Project. In this framework, the Institute developed prototype Space Environment Yellow Pages allowing someone to search and preview space weather data sets available on the Internet. It also participated to the design of the Space Weather European Network (SWENET) providing access to pilot service applications and data through a web portal and web services.

By then, the European Commission was also getting concerned about space weather. Actions were initiated in the framework of the European Cooperation in Science and Technology (COST) in order to improve the networking among the European space weather scientists. The European Space Weather Portal (ESWeP) hosted and maintained at the Institute is one of the outcomes of these actions.



SSA Space Weather Coordination Center (SSC) official inauguration at the Space Pole on 3 April 2013 in the presence of Philippe Mettens (President of the committee of Directors of the Belgian Science Policy, Belspo), Eric Beka (Belgian High Representation for Space Policy) and Thomas Reiter (director of ESA's directorate of human spaceflight and operations).

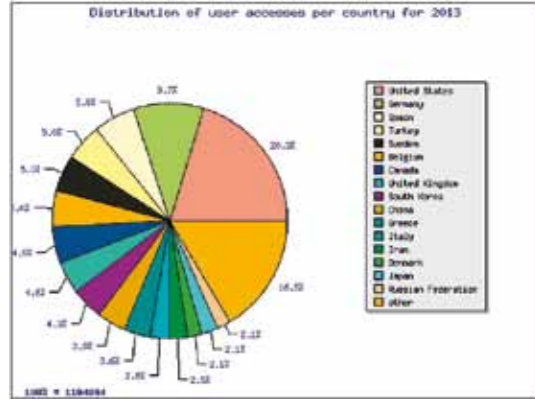

Distribution of SPENVIS users per country for the year 2013.



SPENVIS web page.

In more recent years, Europe's independent access to accurate information regarding space weather hazards to infrastructure became a crucial political cornerstone. In that view, ESA and the European Commission initiated the European Space Situational Awareness (SSA) programme including dedicated space weather segment. The Institute participated to ESA studies for the development of the SSA Space Weather Precursor Service Network and its preliminary operation. This resulted in the implementation of the SSA Space Weather Coordination Centre (SSCC) at the Space Pole and its official inauguration on April 3, 2013. The Institute also took part in space weather research studies funded under the 7th Framework Programme for Research and Innovation (FP7). In particular, the Institute coordinated the project COronal Mass Ejections and Solar Energetic Particles (COMESSEP) providing an alert system forecasting space weather impacts.

Prominent Service Activities

The Space Environment Information System (SPENVIS)

The Space Environment Information System (SPENVIS) has been under continuous development by the Institute for ESA since 1996, providing a user-friendly web-based interface to models for accessing the hazardous space environment and its effects on the spacecraft systems and astronauts.

SPENVIS has today a mature user community that employs the system for mission analysis and planning, educational support (used by technical universities in their educational programs) and scientific applications. Its global success established SPENVIS as an expert system. The system had more than nine hundred new registered users in 2013 with about five hundred active users on average per month. SPENVIS enjoyed its 10000th registered user on 26 February 2013! Most of its users come from ESA Member States, but there is also a significant number of users from outside Europe, especially from the United States, Turkey, Canada, South Korea and China.

A number of SPENVIS User Workshops has been organised by the Institute in order to bring together the users, model developers and the SPENVIS team. In 2013, a workshop took place in Brussels and was particularly successful with more than eighty participants.

A new system called SPENVIS Next Generation is currently under development.

SSA Space Weather Coordination Centre (SSCC)

The SSA Space Weather Coordination Centre (SSCC) is located at the Space Pole in Belgium since 2013. It provides the first European space weather helpdesk, with operators available to answer questions about the SSA Space Weather Precursor Service Network or space weather conditions in general. The SSCC coordinates the provision of space weather services available either at ESA Data Centre or at the various federated sites.

The SSCC monitors the net and provides first-level user support with the help of scientific experts in the fields of solar weather, space radiation, ionospheric weather and geomagnetic conditions. SSCC recently provided support for the launch and insertion manoeuvre of the GAIA mission, and for the Venus Express Aerobraking campaign.

COMESSEP Alert System

The COMESSEP Alert System is an operational space weather alert system that runs without human intervention and was built under the three-year EU FP7 COMESSEP project.

The system includes newly developed tools for forecasting geomagnetic storms and solar energetic particle (SEP) radiation storms. Alerts are triggered by solar phenomena such as CMEs and solar flares. After the automatic detection in solar data of any of these transients, the different modules of the system communicate in order to exchange information. Overall the system produces a series of coherent alerts that are then displayed online. The system provides notifications for the space weather community.

Selected References

Crosby N. B. (2008), Space weather: science and effects, Proceedings IAU Symposium, 257, 47-56, doi:10.1017/S174392130902907X.
 Hapgood M. A. (2010), Towards a scientific understanding of the risk from extreme space weather, Advances in Space Research, 47(12), 2059-2072, doi:10.1016/j.asr.2010.02.007.
 Heynderickx, D. (2002), Radiation belt modelling in the framework of space weather effects and forecasting, Journal of Atmospheric and Solar-Terrestrial Physics, 64(16), 1687-1700, doi:10.1016/S1364-6826(02)00119-0.
 Heynderickx, D., M. Kruglanski, J. F. Lemaire and E. J. Daly (1996), A New Tool for Calculating Drift Shell Averaged Atmospheric Density, in Radiation Belts: Models and Standards, edited by Lemaire, J. F., D. Heynderickx and D. N. Baker, pp. 173-178, American Geophysical Union, Washington, D.C.
 Heynderickx, D., M. Kruglanski, J. Lemaire, E. J. Daly and H. D. R. Evans (1996), The Trapped Radiation Software Package UNIRAD, in Radiation Belts: Models and Standards, edited by Lemaire, J. F., D. Heynderickx and D. N. Baker, pp. 305-309, American Geophysical Union, Washington, D.C.
 Kruglanski, M. (1996), Engineering tool for trapped proton flux anisotropy evaluation, Radiation Measurements, 26(6), 953-958, doi:10.1016/S1350-4487(96)00097-2.

Websites

COMESSEP Alert System
www.comesep.eu

European Space Weather Portal (ESWeP)
<http://www.spaceweather.eu/>

Space Environment Information System (SPENVIS)
<https://www.spennis.oma.be/>

Next Generation SPENVIS (SPENVIS-NG)
<http://spennis-ng.eu/>

SSA Space Weather Service Network
<http://swe.ssa.esa.int/>

Trapped Radiation ENvironment model Development (TREND) Study
<http://trend.aeronomie.be/trends/main/index.shtml>

CHEMICAL DATA ASSIMILATION

Quentin Errera, William A. Lahoz (NILU) and Simon Chabrillat

The notion of “data assimilation” was developed in the meteorological community during the 1960s following increased availability of meteorological satellite instruments, and the increase of computational capabilities. The term “assimilation” was introduced to denote a process in which observations distributed in time are merged with a dynamical numerical model of the atmospheric flow to determine as accurately as possible the state of the atmosphere. Since 1991 and the launch of the Upper Atmosphere Research Satellite (UARS), the number of satellite atmospheric sounders has increased, allowing the application of data assimilation to models of atmospheric chemistry. The data assimilation technique has emerged as a valuable tool to monitor atmospheric composition in a changing atmosphere.

Data assimilation started at BIRA-IASB around 1998 under the leadership of Dominique Fonteyn, who supervised the PhD thesis of Quentin Errera. Their first study focused on the assimilation of stratospheric aerosol observations with a stratospheric transport model, using the four dimensional variational (4D-Var) assimilation method. At that time, it was clear that this was the best assimilation method yet developed but also the most complicated to set-up. The aim of 4D-Var is to optimize model initial conditions to minimize a “cost” function that measures the misfit between the model state and a set of observations given over a time window. Efficient optimization methods usually require the knowledge of the cost function as well as its gradient. The complexity of 4D-Var is associated with the calculation of this gradient, which requires the development of the “adjoint” model which represents the transpose of the Jacobian of the model.

The model was developed further by implementing a stratospheric chemical scheme consisting of 144 chemical reactions and 41 chemical stratospheric species. The assimilated data came from the Cryogenic Infrared Spectrometers and Telescopes for the Atmosphere (CRISTA) flown with the Space Shuttle in 1994 (STS-66) and 1997 (STS-85). The use of the CRISTA data was motivated by the large number of stratospheric trace gases which can be retrieved from such infrared instruments. In the case of CRISTA, the profiles of the following species were assimilated: ozone (O_3), nitric acid (HNO_3), CFC-11, methane (CH_4), nitrous oxide (N_2O), dinitrogen pentoxide (N_2O_5) and chlorine nitrate ($ClONO_2$). Another good reason to use the CRISTA data was the good contact we had with the CRISTA team after our first meeting at a COSPAR symposium held in Nagoya (Japan) in 1998.

The assimilation of CRISTA measurements showed that the “analyses”, i.e., the chemical fields produced by the assimilation system, were in good agreement with independent (i.e., not assimilated) observations. A



Cryogenic Infrared Spectrometers and Telescopes for the Atmosphere CRISTA. (credit: NASA)

remarkable result was that the assimilation was able to constrain the unobserved species hydrogen chloride (HCl) thanks to the assimilation of $ClONO_2$ and the presence in the model of the chemical coupling between these two species.

BIRA-IASB has continuously improved this system, now known as the “Belgian Assimilation System for Chemical Observations” (BASCOE). It has been applied to observations from the ESA Environmental Satellite (ENVISAT) and the NASA Aura Earth Observation Satellite (EOS), to perform several studies: the calibration and validation of the MIPAS observations, an intercomparison of different assimilation systems, reanalyses of ozone, and a case study of a major dynamical event in the Arctic stratosphere.

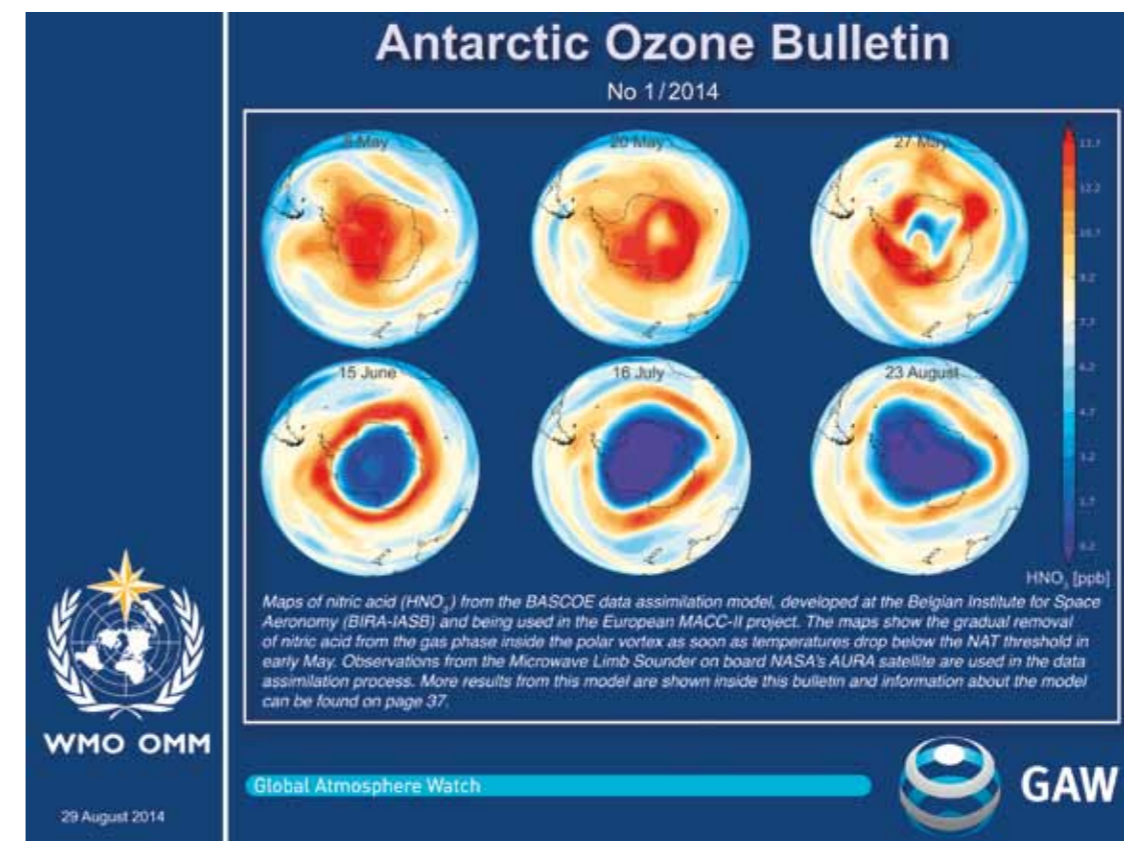

The Global Atmosphere Watch (GAW) cover page of the first 2014 Antarctic Ozone Bulletin published by the World Meteorological Organization (WMO), with Maps of nitric acid from the BASCOE data assimilation model, developed at BIRA-IASB.

During this period emerged a fruitful collaboration between Quentin Errera and William A. Lahoz (at that time at the University of Reading, UK; now at NILU, Norway), involving the assimilation of stratospheric ozone data, and the use of stratospheric data such as ozone, methane and water vapour (from analyses, observations and models) to understand the chemical and dynamical evolution of the stratosphere.

The stratospheric chemical scheme of the BASCOE system was also implemented into a research version of the Numerical Weather Prediction (NWP) model developed by Environment Canada, thanks to an ESA-funded project led by Richard Ménard. This resulted in the first NWP system to include a fully online and explicit solver for atmospheric chemistry, allowing a new look at the couplings between atmospheric dynamics and chemistry.

Several peer-reviewed papers and a contribution to a well-received book on data assimilation have resulted from these two collaborations.

BASCOE is also used within the pre-operational atmospheric component of the European programme Copernicus Atmosphere, which aims at monitoring atmospheric composition. In Copernicus, BASCOE delivers daily analyses of stratospheric ozone as well as other species related to ozone. The analyses are produced routinely with a delay of 4 days from the time the observations are made. They are used by the Global Atmospheric Watch (GAW) service of the World Meteorological Organisation (WMO), which publishes a bi-monthly bulletin on the state of the stratospheric composition. This is illustrated in Fig. 1, which shows the distribution of nitric acid (HNO_3) above Antarctica on several dates during the Antarctic winter 2014 based on BASCOE analyses.

In the coming years, the stratospheric chemical scheme of the BASCOE system will be implemented in the chemical module of the assimilation system of the European Center for Medium Range Weather Forecast (ECMWF). This system provides daily analyses and 5-days forecasts of the chemical composition of the atmosphere and ECMWF hopes to improve significantly its representation of the chemical state of the stratosphere thanks to this chemical scheme developed at BIRA-IASB.

Selected References

Errera, Q. and D. Fonteyn (2001), Four-dimensional variational chemical assimilation of CRISTA stratospheric measurements, *Journal of Geophysical Research: Atmospheres*, 106(D11), 12253-12265, doi:10.1029/2001JD900010.

Lahoz, W.A. and Q. Errera (2010), Constituent assimilation, in *Data Assimilation: Making sense of observations*, edited by Lahoz, W.A., B. V. Khatattov and R. Ménard, pp. 449-490, Springer, Heidelberg.

DETECTION OF VOLCANIC ERUPTIONS

Nicolas Theys and Hugues Brenot

Volcanic eruptions can emit large quantities of aerosols (silicate ash, sulfuric acid, ice) into the atmosphere as well as several trace gases, such as water vapour, carbon dioxide (CO_2), sulfur species (SO_2 , H_2S) and halogens (HCl, HBr, HF). These volcanic ejecta can have a considerable impact on atmospheric chemistry and climate, both at local and global scales, depending on volcanic cloud composition and injection height.

While the immediate surroundings of a volcano can be threatened by lava flows and falling rock fragments, volcanic aerosols and gases can strongly affect the environment, climate, human health via its impact on air quality, and society, locally but also over long-distances (>1000 km from the volcano). In particular, volcanic ash and -to a lesser extent- sulfuric gases are known to be a major threat to commercial jet aircrafts. Ash can melt and block the engines, causing the planes to stall.

Remote measurements of volcanic gases and aerosols from satellite nadir sounders was pioneered in the mid-seventies when it was shown that SO_2 measurements in the UV spectral range could be made by the Total Ozone Mapping Spectrometer. Since then, measurements from space have undergone an appreciable evolution and are now considered as an essential component of the observing system for volcanic emissions in support of scientific research but also in support of crisis management related to volcanic eruptions. Indeed, thanks to their complete global spatial and temporal coverage, they provide measurements even during the most dangerous on-going eruptions. Over the last decades, a multitude of satellite-based instruments operating in the UV-visible, near infrared, and thermal infrared have been used to monitor and study volcanic emissions in the atmosphere. Owing to improvements in instrumental performances and characteristics in terms of spectral and spatial resolution and coverage, not only SO_2 has been measured but other less abundant volcanic gas species could also be detected from space (H_2S , BrO and very recently CO). More importantly, direct detection techniques of volcanic aerosols (ash and sulfuric acid) have also become available, especially with the advent of hyperspectral infrared sounders.

Research activity related to the detection and monitoring of volcanic emissions has become increasingly important at BIRA-IASB since the years 2000s. The emphasis has been on the continuous improvement of SO_2 retrievals from UV-visible sensors as SCIAMACHY and GOME-2, towards accurate estimation of SO_2 amount, but also of the altitude of the SO_2 plume. In addition, a study aiming at the determination of temporally-resolved SO_2 fluxes has been recently undertaken demonstrating the potential of satellite measurements to analyse underlying eruptive mechanisms. Parallel research on satellite monitoring of reactive

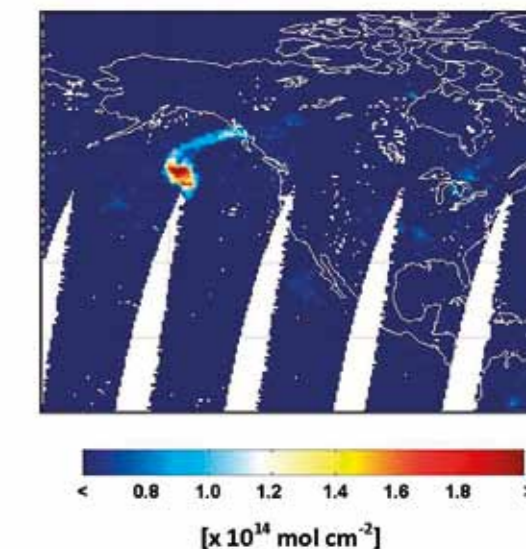

The first detection of volcanic BrO emission from space on 10 August 2008: Total BrO columns by GOME-2 after the eruption of Kasatochi.

halogens has also allowed the first detection of volcanic BrO emissions from space, offering new perspectives for the monitoring of bromine emissions and for the understanding of its global relevance for the oxidising capacity of the atmosphere.

Over the last few years, BIRA-IASB also developed the Support to Aviation Control Service (SACS), which aims at making optimal use of current satellite sensors in support of volcanic hazard warning. An important difficulty in mitigating volcanic hazard to aviation comes from the fact that fine ash can be rapidly transported and cross major air routes. In this respect, the recent eruption of the Icelandic Eyjafjallajökull volcano in 2010 is a perfect example of how the dispersion of a volcanic cloud can critically affect air traffic at the continental scale. SACS is a near-real time system for the detection and monitoring of volcanic emissions of ash and SO₂. It provides an essential and free source of information to a wide community of users in the context of civil aviation and volcanic activity surveillance. SACS has been developed and continuously improved over the last years by BIRA-IASB, in collaboration with the Free University of Brussels (ULB), the Royal Netherlands Meteorological Institute (KNMI), the German Aerospace Centre (DLR) and the European Space Agency (ESA; funding agency). At the time of writing, SACS integrates in a single system satellite data products from four instruments operating in the UV-visible (GOME-2, OMI) and thermal infrared (IASI, AIRS). These sensors are on board European (MetOp-A) and American (Aqua and Aura, flying on the A-Train) platforms and have complementary overpass times. SACS also includes a unique worldwide multi-sensors SO₂ warning system notifying the users by e-mail in case of exceptional volcanic emissions. SACS is a global system that proved to be very useful over the last years to monitor the dispersion of volcanic plumes after explosive eruptions.

Selected References

Brenot, H., N. Theys, L. Clarisse, J. van Geffen, J. van Gent, M. Van Roozendael, R. van der A, D. Hurtmans, P.-F. Coheur, C. Clerbaux, P. Valks, P. Hedelt, F. Prata, O. Rasson, K. Sievers and C. Zehner (2014), Support to Aviation Control Service (SACS): an online service for near-real-time satellite monitoring of volcanic plumes, *Natural Hazards and Earth System Sciences*, 14(5), 1099-1123, doi:10.5194/nhess-14-1099-2014.

Theys, N., M. Van Roozendael, B. Dils, F. Hendrick, N. Hao and M. De Mazière (2009), First satellite detection of volcanic bromine monoxide emission after the Kasatochi eruption, *Geophysical Research Letters*, 36(3), L03809, doi:10.1029/2008GL036552.

Theys, N., R. Campion, L. Clarisse, H. Brenot, J. van Gent, B. Dils, S. Corradini, L. Merucci, P.-F. Coheur, M. Van Roozendael, D. Hurtmans, C. Clerbaux, S. Tait and F. Ferrucci (2013), Volcanic SO₂ fluxes derived from satellite data: a survey using OMI, GOME-2, IASI and MODIS, *Atmospheric Chemistry and Physics*, 13(12), 5945-5968, doi:10.5194/acp-13-5945-2013.

Website

Support to Aviation Control Service
sacs.aeronomie.be



Ash plume from the 2010 eruption of Eyjafjallajökull volcano. (Reuters/Lucas Jackson).



BELGISCH INSTITUUT VOOR RUIMTE-AERONOMIE (BIRA) / INSTITUT D'AERONOMIE SPATIALE DE BELGIQUE (IASB) / BELGIAN INSTITUTE FOR SPACE AERONOMY (BIRA-IASB) / BELGISCH INSTITUUT VOOR RUIMTE-AERONOMIE (BIRA) / INSTITUT D'AERONOMIE SPATIALE DE BELGIQUE (IASB)

TECHNICAL SUPPORT AND EXPERTISE

Eddy Neefs, Jeroen Maes, Sophie Berkenbosch and Johan Bulcke



BIRA-IASB electronic workshop in the sixties.

Eddy Neefs and Johan Bulcke

For many of the scientific efforts performed at BIRA-IASB, technical support is crucial. Whether our scientists are active in theoretical research, modelling or data analysis, or implied in experimental aeronomy in the laboratory or by means of ground-based or spaceborne instruments, a variety of technical needs arises from their work. Examples of technical support are the selection, installation and maintenance of IT (information technology) infrastructure, onground software and onboard firmware development, electronics and mechanics design, prototyping, manufacturing and testing, and low-level instrument operations. This expertise is provided by the engineering team and IT service.

Engineering has been present in BIRA-IASB from the early beginnings, as part of the department for Applied Aeronomy. This department was for many years led by *Dirk Frimout* until he left to ESA in 1978 to become Belgium's first astronaut. Originally, the department also hosted the IT division, but with the steep growth of this discipline and the increasing importance of computers in science, engineering and IT became two independently managed groups in the institute, still serving though one common interest: allowing scientists to perform studies and experiments in the field of aeronomy with up-to-date technical support and expertise.



Dirk Frimout (March 21, 1941, Poperinge, Belgium), engineer and astrophysicist, the first Belgian in space aboard the NASA Space Shuttle Atlantis mission STS-45 in 1992. From 1965 until 1978 he worked at the Belgian Institute for Space Aeronomy.

INFORMATION TECHNOLOGY

Johan Bulcke, Carlos Lippens and Dennis Nevejans

History

Information technology has been part of the daily activities at the institute almost from its inception. In the early days, this was limited to the use of some of the first computer systems on the market as dedicated laboratory equipment. Quite soon, however, this evolved into the use of computer systems to automate data processing and to compute the complex mathematical equations of atmospheric or chemical models. In present-day scientific research, the powerful IT infrastructure has become as much of an indispensable tool as pencil and graph paper were 50 years ago.

The Institute has always been at the forefront of technology, be it in electronics, mechanics or computing. It is therefore not surprising to see that the first computers already appeared at the institute during the 1960s, at a time when for most people they still were in the realm of science fiction. At that time, the systems were managed by people from the engineering department, who had experience with electronics equipment. Later on, the practical use of these systems for calculations was in the hands of 'calculators': staff members who had the dedicated task of doing the complex calculations and data processing demanded by the scientists. Over the course of the years, their jobs evolved from the use of 'slide rules' over the use of electronic calculators to the programming of the first computers in languages such as Fortran and Basic.

During the 1980s and 1990s, the computer systems became more and more commonplace, with the 'Personal Computer' replacing the existing centralized mainframe- and minicomputers. These systems were still managed by engineers or by the scientists themselves. It was only in the middle of the 90s that the first dedicated IT support personnel appeared.

Until the end of the 90s, IT was still firmly embedded in the engineering department and was offered as an added service, complementary to the engineering tasks. During the course of the last decade, the use of computing exploded and the IT service finally evolved into an independent department within the institute.

Over the last 30 years, the collaboration between the 3 institutes of the Space Pole intensified. As the 3 institutes have very similar needs what IT is concerned, some of the larger IT projects were executed in a common framework, named *AMABEL*. The *AMABEL* project gave birth to several generations of supercomputers, file servers and high bandwidth internet connectivity and has been a very successful example of inter-institute collaboration.

AMABEL, Aeronomy-Meteorology-Astronomy-BELgium, is the common ICT workgroup of the Space Pole (BIRA-IASB, KMI-IRM, KSB-ORB).



IT hardware maintenance in the computer room at BIRA-IASB.

Activities

The activities of the current IT service cover several broad categories. One of them is basic office automation, which consist primarily of the IT one finds in most enterprises: desktop or laptop computers, the programs which are used on a daily basis (like word-processors, e-mail, etc.), internet connectivity and all supporting servers and services. A second category consists of more specialized IT services, which are specific to the research environment. These include High Performance Computing (HPC), large capacity data storage and support for operational tasks, such as data processing. A third category is project-bound and concerns IT assistance in the form of data management, web services and general IT consultancy.

Today, the IT department has a full-time staff of 9 persons to execute all of its tasks. Among the profiles we find experts in networking, high performance computing, infrastructure management, personal computing, data management and web services.

Infrastructure

The Institute has always been at the leading edge of the market for IT material. State of the art equipment is necessary to remain at the top in the fast moving world of scientific research. This has always been realized in close collaboration with the major computer manufacturers in the field, so much so that we have had several occasions where new generations of computer servers were installed on-site before they became generally available on the market.

Several high-end systems have graced the data center of the Institute over the years. Some of the most interesting computers have been, in order of age: the IBM 1800 system (the first system and really only useable by electronics enthusiasts), an HP 2100 minicomputer with a huge (!) 32KiB memory, the HP 1000 minicomputer (used as ground support equipment for 2 shuttle missions), a UNIVAC 1100 mainframe and the Convex C1, Cray J916, SGI Origin and Altix supercomputers.

Because of this long history, the institute has closely followed the advancement in digital electronics and seen an increase in computer calculating power of 10^{10} , i.e. we have now 10000000000 times more compute capacity than in the earliest days.

The same evolution is seen in the explosion of scientific data at the Institute. Where we started out with hand-written measurements, carefully penned down in notebooks and on graph-paper, we now manage an impressive volume of satellite- and ground-based experiment data, modeling data and scientific results. At this moment, we have some 300 terabyte (the equivalent of 60000 DVD's) of data that are permanently stored and at the disposal of the scientists for their work.

This is a long step up from the data and programs being stored successively on punch cards, paper tapes, huge tape reels and refrigerator-sized hard drives (of 1 MB!).

These improvements have not stopped the scientific research of always needing more capacity. The growths of the IT infrastructure and advancements in technology have barely been able to keep pace with the continuous growth of data volumes and with the improvements in scientific processing techniques.

These needs have required a transformation from the computer infrastructure from an almost experimental era with exciting new hardware in the early days to its present day state of a professional data center, functioning 24 hours, 7 days without interruption.

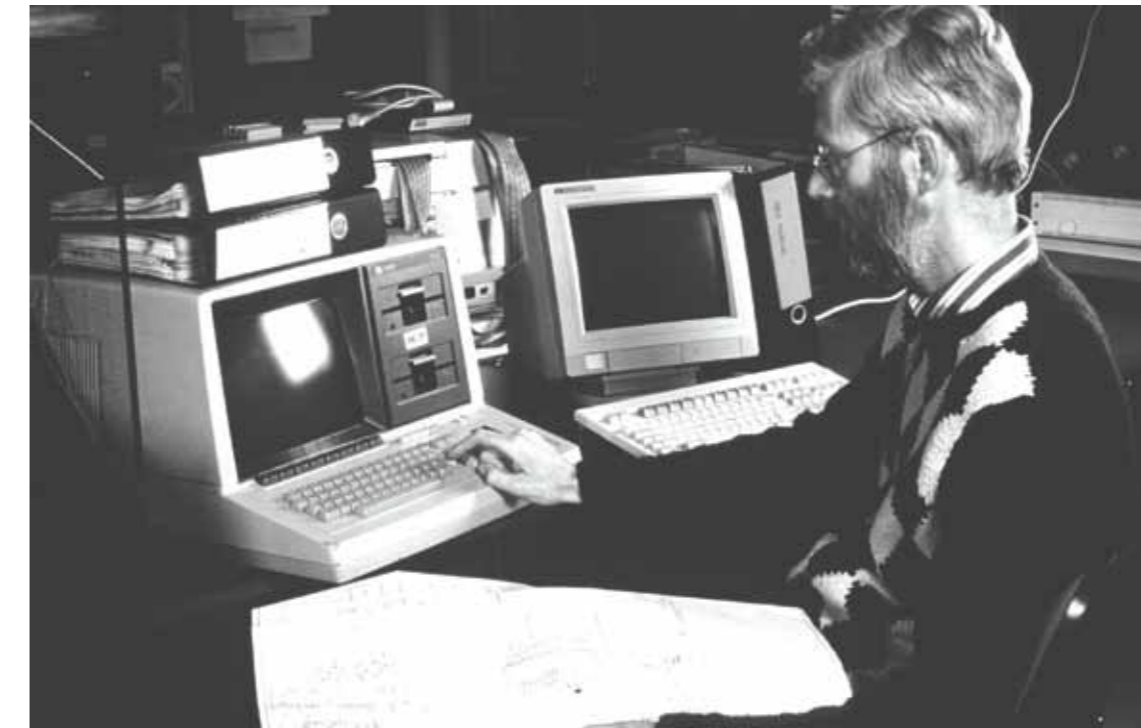

Some figures of the current infrastructure:
Compute cores (processors) > 400,
performance > 4 Tflops*
Data storage > 300 terabyte
Network bandwidth: 10 Gbit/s (internet: 1 Gbit/s)

*Tflops means teraflops. Flops stands for Floating-point Operations per Second. This is a measure for computer performance (how fast a computer can perform calculations), used frequently in the scientific world. Teraflops means 10^{12} flops.

BIRA-IASB electronic workshop in the eighties.

ELECTRONICS, SOFTWARE AND FIRMWARE DEVELOPMENT

Eddy Neefs, Sophie Berkenbosch and Dennis Nevejans

An FPGA, Field-Programmable Gate Array, is an electronic component designed to be configured by a user after manufacturing. Such a compound is able to perform complex computations.

Electronics play a key role in modern spaceborne and ground-based instrumentation as they are often remotely controlled by a digital telecommanding interface, they produce data and housekeeping streams to be collected and rapidly treated or monitored, or they are equipped with controlling intelligence. Moreover, nowadays, almost all space instruments contain some microprocessor or FPGA based internal intelligence. The Laboratory for Electronics of BIRA-IASB has in-house facilities and tools for the major electronic and firmware design phases.

The electronics lab at BIRA-IASB has gone through an enormous evolution. In the early years, electronics for scientific instrumentation consisted of discrete components: transistors, hybrid operational amplifiers, resistors and condensers. Programming of e.g. balloon-borne equipment was based on mechanically driven timers, data was recorded at that time by means of penrecorders and paper. Little by little integrated operational amplifiers



Technician in the electronic workshop at BIRA-IASB.



Electronic workshop at BIRA-IASB in the recent years.



Engineer in the electronic workshop at BIRA-IASB.

and logic devices such as gates and flipflops found applications as instrumentation grew more complex and digital remote communication became a necessity. Heavy lead batteries were replaced by the much lighter, smaller, and much more reliable batteries based on nickel and cadmium and later by lithium batteries.

Although the capabilities of the first microprocessors were negligible compared to what processors can perform today, the new techniques were introduced and applied from the very beginning. Step by step, the engineering department gained experience in the development of onboard software for such embedded systems. In the middle of the 1990s, BIRA-IASB launched a balloon-borne mass spectrometer that was controlled completely by microprocessors, carrying a multitasking operating system, capable of receiving textual telecommands from ground and of transmitting its data digitally to ground, where it was processed and stored in real-time.

With the arrival of the microprocessor also the personal computer and the workstation made their appearance in the electronics lab. The development of onboard software has gone hand in hand with the design of computer-based ground support equipment capable of controlling the scientific instrumentation ever since. Where driving electronics for scientific equipment in the seventies was rather spacious and power consuming, it has evolved into more and more light-weight, compact, low-power concepts in the 21st century, with far more easy access to space applications. With the rise of micro-, nano- and even pico-satellites, this tendency to miniaturize is presumably not yet to stop.

Micro-, pico- and nanosatellites are (very) small artificial satellites. The difference is based mainly on mass: microsatellites have a mass between 10 and 100 kg, nanosatellites have masses between 1 and 10 kg, while the mass is between 0.1 and 1 kg for picosatellites. For comparison, a regular satellite usually has a mass of several hundreds of kilograms.

MECHANICAL DESIGN AND CONSTRUCTION

Eddy Neefs, Jeroen Maes, Sophie Berkenbosch, Emiel Van Ransbeeck and Dennis Nevejans

Every spaceborne or ground-based instrument has a mechanical structure in which its electronics or optical devices are housed and protected. The Workshop for Mechanics of BIRA-IASB is well equipped for the design and construction of mechanical parts dedicated for ground, balloon or spaceborne instruments. For 2D and 3D mechanical design, workstation-based CAD (Computer Aided Design) tools are used, supported by CAM (Computer Aided Manufacturing) software to convert it into commands for numerically controlled milling machines. Since three years, prototypes can be quickly built by the institutes 3D-printer to check the feasibility of the design.

While during the early years the mechanical workshop focused on building the hardware in-house, using a suite of lathes, milling, drilling and plate handling machines, with time the focus has shifted more and more towards design for space applications, where complexity and light-weighting became prominent issues and, hence, collaboration with specialized industrial partners for manufacturing became a need.

BIRA-IASB's mechanical engineers are specialized in mechanisms for rotation or translation of optical and mechanical elements, structural design work, pneumatics and space-qualified mechanics.

In the last two decades, BIRA-IASB's involvement in satellite-borne instrumentation has increased dramatically. Compared to ground-based or balloon equipment, spaceborne applications require completely different design rules. Instruments have to resist the heavy vibrations and shocks experienced during a rocket launch, and they have to cope with the harsh radiation and thermal environment in space. Both the electronic and mechanical development need much more time than it used to, as well in design as in manufacturing and testing.



Mechanical design engineers at work in BIRA-IASB.



Mechanical workshop technician at BIRA-IASB.

IMPORTANT CONTRIBUTIONS TO SCIENCE INSTRUMENTATION

Eddy Neefs, Jeroen Maes and Sophie Berkenbosch

As BIRA-IASB was founded at the time of Europe's first steps into space research, the contributions of its engineering team followed the same technological path of evolution as its European counterparts.

In the beginning the focus was put on stratospheric balloon flights (the first balloon launch of a BIRA-IASB instrument took place in 1967) as Europe did not possess a mature launching capability at that time, like the United States and the Soviet Union did. These balloon flights enabled the institute to perform atmospheric measurements high up in the stratosphere at an altitude of 20-50 km with payloads ranging from 10 to 300 kg. In its heyday, up to four of these payloads were built and launched into the stratosphere each year from different locations. These launching sites were situated in Southern France, Spain, and even Texas, Brazil and French Guyana.

Another step to true space research was taken by participating in several sounding rocket missions. From 1969 up to 1974, small payloads, developed at BIRA-IASB, were launched into sub-orbital space with rockets like Skylark, Skua, Super Arcas and Centaure.

With the establishment of ESA in 1975, Europe slowly moved towards a mature space power in close collaboration with NASA. One of ESA's biggest achievements in its early years was the realization of the laboratory SPACELAB on board Nasa's Space Shuttle. The engineering department of BIRA-IASB developed the instruments ALAE, SOLSPEC and the Grille Spectrometer for the SPACELAB flight in 1983 (see chapter 7).

Towards the nineties, and as the engagement in balloon flights was slowly winding down, the institute geared up its space activities and realized a whole fleet of instruments for a large range of measurement domains. SOLSPEC was launched another time to space in 1992 on board the EURECA platform, Europe's retrievable carrier, together with the new ORA instrument (see section "EURECA", chapter 7). The flight of Dirk Frimout with space shuttle Atlantis in 1992 had several instruments of the institute on board. The instrument SOLSPEC was launched again several times as part of the ATLAS flights on board the Space Shuttle in 1993, 1994 and 1995.

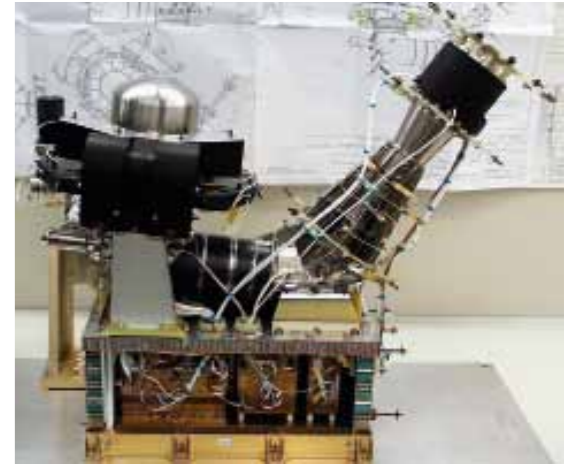

Qualification model of Rosetta DFMS spectrometer developed by BIRA-IASB

MIR station was a Russian (first Soviet) space station which circled around the Earth from 1986 until 2001. It was used for different experiments. The word MIR means both peace and world.

Klim Ivanovich Churyumov (February 19, 1937, Ukraine) Ukrainian astronomer specialized in comets and Svetlana Gerasimenko (February 23, 1945, Ukraine), astronomer in Tajikistan, discovered comet 67P/Churyumov-Gerasimenko, the target of the ESA Rosetta mission, in September 1969.

The Institute did, however, not restrict its collaboration to ESA and NASA but also partnered up with Russia. As a result, the large MIRAS instrument was installed on the outside of the Russian MIR station in 1995. The ill-fated Mars-96 satellite had SPICAM-S, SPICAM-E and MAREMF on board as contributions of the institute. The Mars-96 mission unfortunately crashed shortly after its launch from Russia's cosmodrome in Baikonur. However, all work on this latest mission was not lost because some of the technologies were redeveloped into a new instrument: SPICAM-light was placed on board ESA's first interplanetary probe Mars Express, launched in 2003. With this instrument, the BIRA-IASB engineering hardware left the Earth's orbit for the first time. After 10 years in orbit around Mars, the spectrometer still keeps sending scientific data to Earth.

It would be the first but not the last interplanetary hardware of the institute to leave Earth's orbit. One year later, in 2004, ROSINA on board of Rosetta began its long journey to comet 67P/Churyumov-Gerasimenko (see chapter 13). This complex mass spectrometer samples and analyzes the gas molecules inside the tail of the comet while it approaches the Sun.

One of the Institute's masterpieces is the SOIR channel which is part of the SPICAV instrument embarked on board ESA's Venus Express spacecraft. The other part of SPICAV consists of a copy of SPICAM-Light, this time outfitted with a shutter mechanism to protect the instrument against the fierce direct sunlight around Venus. The engineering team of BIRA-IASB was responsible for the complete electronics and mechanics of



Cutaway of SOIR instrument on board Venus-Express.

SOIR, including its onboard firmware, and has complemented this work by taking in charge the operations of the instrument. Since its launch in November 2005, SOIR continues to perform nominally and has already discovered many interesting features in the atmosphere of Venus, including the first observation of the 628 CO₂ isotopologue band. Today SOIR has become the predecessor of a new instrument, called NOMAD, that will be installed on ESA's ExoMars mission which targets its launch in early 2016.

Also the SOLSPEC instrument has been redesigned and rebuilt to become part of the SOLAR platform on the outside of the International Space Station (ISS). Since its launch in 2008 it relays its data to B.USOC, the Belgian User Support and Operations Centre, located inside the institute (see chapter 16).

In the field of space radiation research, a new compact spectrometer was developed: the Energetic Particle Telescope, shortly EPT. This instrument was launched in 2013 on board the PROBA-V satellite and relays real-time radiation data of the Earth's low orbit directly to B.USOC. A technological spin-off to measure radiation under different angles called 3DEES is currently under development.

In many of these projects the engineering team has been closely working together with Belgian industrial partners such as OIP, Verhaert Space (now QinetiQ Space), Alcatel-ETCA, Lambda-X, AMOS and IMEC. Also intense technical collaborations exist with Belgian universities and partner research institutes or industrials throughout the world.

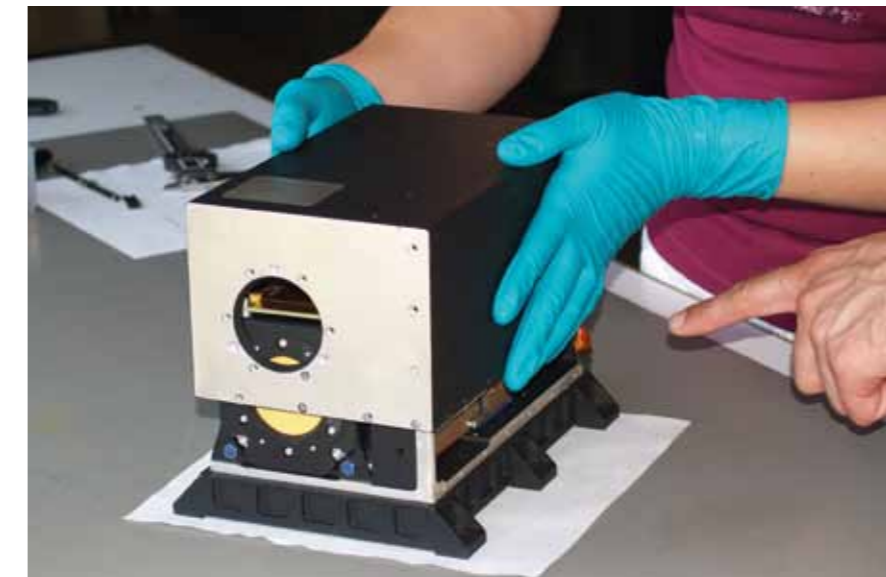

Integration of the Electronic Particles Telescope (EPT) at BIRA-IASB.

Isotopes are different "versions" of the same chemical element. They only differ in mass. Chemical compounds that exist with different isotopes of the elements they are built of, are called isotopologues. The 628 CO₂ isotopologue contains ¹²C¹⁶O¹⁸O.

PROBA satellites are microsattellites. These satellites are developed for carrying instruments around the Earth. PROBA stands for PProject for On Board Autonomy. The satellites are the result of a collaboration of ESA with the Belgian company Verhaert Space (now QinetiQ Space).

16

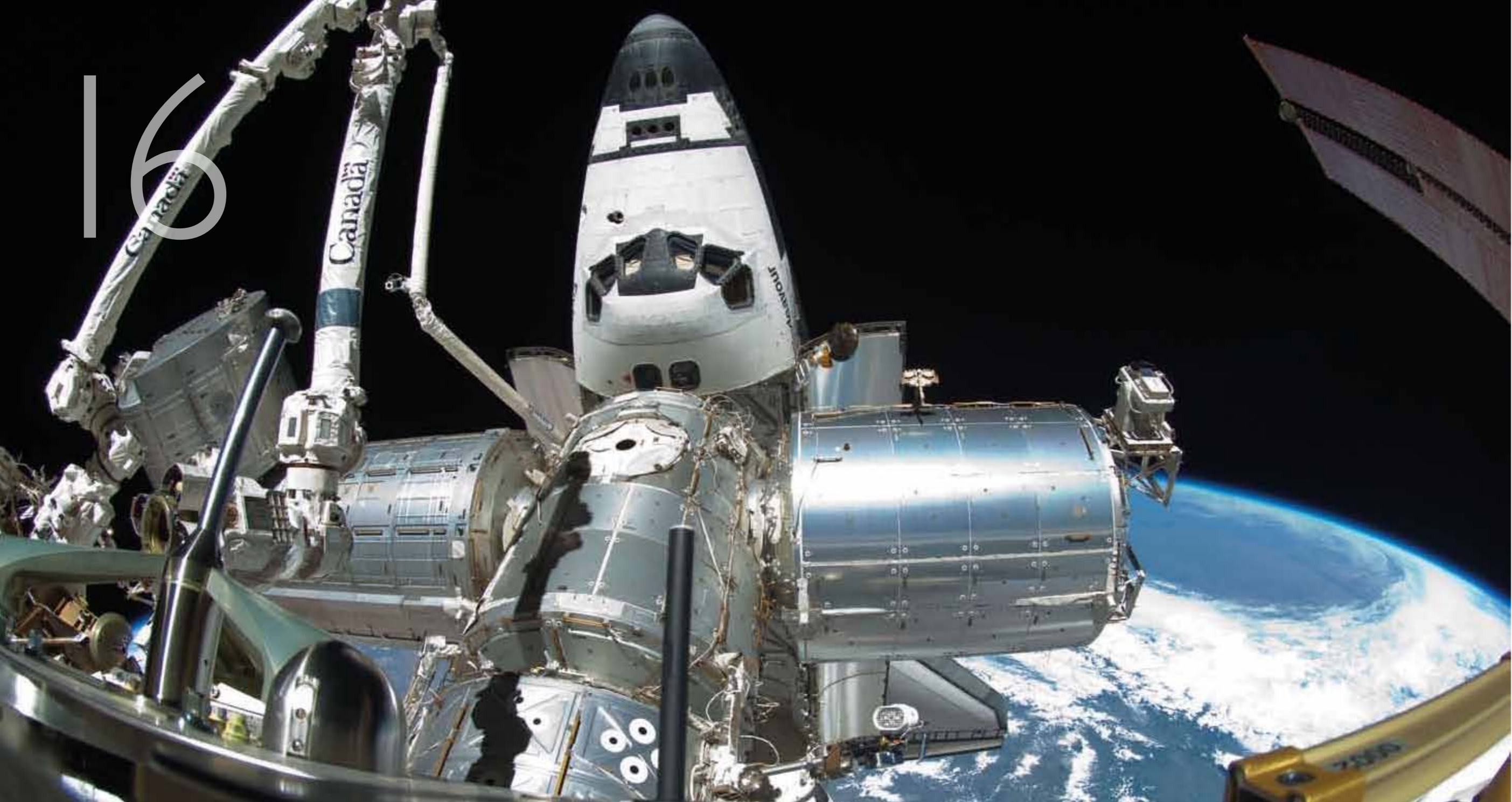

BEELICH INSTITUUT VOOR RUIMTE-AERONOME (BIRA) INSTITUUT D'AERONOME SPATIALE DE BELGIQUE (IASB) BELGIAN INSTITUTE FOR SPACE AERONOMY (BIRA-IASB) BELGICH INSTITUUT VOOR RUIMTE-AERONOME (BIRA-IASB) BELGICH INSTITUUT D'AERONOME SPATIALE DE BELGIQUE (IASB)

SPACE OPERATIONS AND KNOWLEDGE MANAGEMENT

Didier Moreau

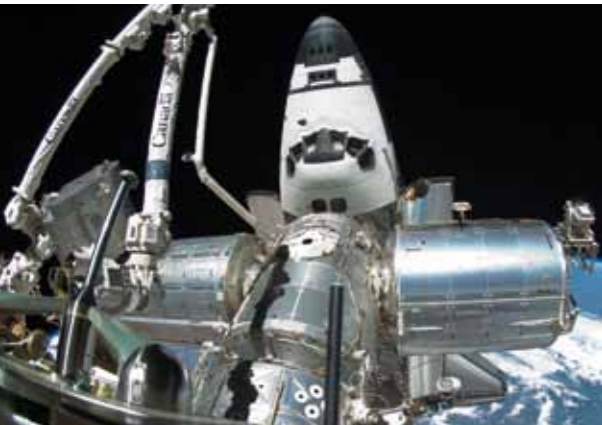

Endeavour space shuttle and the European Columbus Module with the SOLAR external payload. (credit NASA)

Christian Muller and Didier Moreau

At the beginning of the space age, it was evident that payload operations were managed by scientists. On SPUTNIK I for example, the only scientific instrument, which was a radio emitter, was switched on the launch pad by Konstantin Gringauz, who later became a prominent space scientist. On the American side, James Van Allen and other scientists were also present on the launch pad to make the latest instruments set ups.

During the sixties, also at the Belgian Institute for Space Aeronomy, payloads on board sounding balloons were operated by scientists, by using a mix of a mechanical programmer (which was set by the scientist before launch) and a few discrete analogue commands (see chapter 6). The science data acquired by analogue telemetry were often recorded on paper rolls and, in parallel, on a magnetic tape. The latter was treated only if the quality of the paper recording was too low. With the apparition of digital commanding and recording capabilities in the seventies, this situation evolved as scientists got able to operate the balloon payloads in real time, allowing to maximize the scientific return.

The next step came in 1976, when BIRA-IASB had three instruments (GRILLE, SOLSPEC, and ALAE) accepted on the SPACELAB I platform (see chapter 7). At that time, it was officially required to have each SPACELAB instrument controlled by an astronaut. The ESA SPACELAB programme was to be completed by one test flight, four demonstration flights and twenty operational flights. At the time of the first flight in 1983, ESA supported only half of the test flight, the other one being operated by NASA, while the later flights were entirely operated by NASA. As this first flight had more than 70 instruments on board, having these operated by individual astronauts was unmanageable. It could not be left to the Houston flight controllers either, as was done in the APOLLO programme. Therefore, NASA created the POCC (Payload Operation Control Centre) and ESA assisted the European scientists by creating the position of ESA Ops (ESA operational engineer).

To be able to command their instruments, scientists had to make a request to the Payload Operation Director, after which they could directly manage their instrument from the Houston Operations Center using a very primitive display. They could follow their instrument on their own EGSE (Electronic Ground Support Equipment) using their own software. SPACELAB I turned out to be a great operational and scientific success for most instruments. Therefore, NASA kept the operation concept but moved the POCC from Houston to Marshall Space Flight Centre in Huntsville (Alabama).

THE ATLAS MISSION OPERATIONS: THE SPACE REMOTE OPERATION CENTRE

Didier Moreau and Christian Muller

The hitchhiker project has been established in 1984 to develop and operate a carrier system for low-cost and quick reaction accommodation of secondary payloads on the NASA Space Transportation System (STS). The management of the project was the responsibility of the NASA Goddard Space Flight Center (GSFC). For the missions STS-65, 66, 85, and 95, it was necessary to remotely command the Total Solar Irradiance (TSI) instrument. To achieve this, both an internet link and an Integrated Services Digital Network (ISDN) link were made between the Royal Meteorological Institute's Space Remote Operation Centre (RMI/SROC) and the Goddard and Marshall Space Flight Center (GSFC/MSFC). The latter was provided by BIRA-IASB through a Virtual Local Area Network. BIRA-IASB also provided the Interconnection Ground Subnetwork (IGS) for the SROC SOLCON/HH missions.

This paved the way to a more decentralized operational approach. In Brussels, the SROC at the Royal Meteorological Institute supported two instruments: the Solar Spectrum experiment (SOLSPEC) and the Solar Constant experiment (SOLCON). This positive experience led the Belgian Science Policy Office (Belspo) to propose, in the frame of the emerging ESA contribution to the International Space Station (ISS) commercialisation programme, a joint venture with BIRA-IASB to develop and implement a new space operations centre inside their premises: the B.USOC (Belgian User Support and Operations Centre) was born.

THE BELGIAN USER SUPPORT AND OPERATIONS CENTRE

Didier Moreau and Marie-Claude Limbourg

Belgium's involvement in the ESA/ISS optional program is mainly driven by the opportunity for Belgian scientific communities to receive support from and to access a unique research facility to develop, implement and conduct their fundamental and applied research activities. Since 15 years now, Belpo and the Space Pole invest in the development of a unique infrastructure to meet these objectives. In this regard and in order to conduct operations in the European facilities on board ISS, the European Space Agency decided to implement a decentralized and hierarchical user centre approach.

Belgium fully embraced this decentralization approach allowing its scientific community to develop, implement, realize and valorise experiments inside and outside the European Columbus facility after its launch. Entering this programme, Belgium also wanted to ensure sustainability of the Belgian Operational Centre developed for ATLAS missions and located inside the Space Pole premises.

The B.USOC as a decentralized centre for the new ISS project was then funded and implemented inside the BIRA-IASB premises. As part of the ISS agreement between ESA and Belgium, this centre began its implementation in 1997 with funding by General Support Technology Programme (GSTP) and took over the operational responsibilities of SROC, specifically in terms of NASA space shuttle operations. The official service contract between Belgium and ESA was signed in 1999 and B.USOC became an official operational node of the European ISS ground segment network.

During the pre-Columbus launch phase, in order for the B.USOC to prepare its first assigned SOLAR and PCDF operations as Facility Responsible Centre (FRC), the Belgian Government funded some of the most productive and challenging scientific ESA ISS missions such as the Belgian OdISSea mission and the PromISse missions. Moreover, Belgium has also funded experiments which flew during the Spanish CERVANTES mission and two experiments composing the SOLAR platform: SOVIM and SOLSPEC.



The ISS COLUMBUS NATIONAL USOCs network.

Facility Responsible Centre (FRC):

is the organization to which the overall responsibility for a payload on board the International Space Station is delegated by ESA. Its functions focus on payload systems aspects and are related to all phases of payload operations, i.e. pre-flight activities, in-flight operation and post-flight activities.

ODISSEA AND CERVANTES MISSIONS

Marie-Claude Limbourg and Didier Moreau

The first complete operations for the B.USOC were done during the OdISSea Taxi-flight mission of the Belgian astronaut Frank De Winne in November 2002. For this ambitious mission, more than 50 scientific and industrial teams participated leading to an activity level comparable to SPACELAB missions. The OdISSea experimental programme was the most important ever realized on the International Space Station during a Taxi-flight mission. For the first time, the American segment was used in conjunction with the Russian segment. The OdISSea Mission has thus been the first step in coordinating ISS Operations with multiple partners.

At that period, neither NASA nor Russia had done payload operations across multiple control centres and continents. After this mission, B.USOC was fully integrated in the ESA, NASA and Russian communication networks and delivered all the data requested by the Scientific Principal Investigators to their user home bases (UHB). This last concept (UHB) allows the scientists, with the support of the B.USOC, to monitor their experiment and record the raw scientific data they requested using commercial internet and their own computers at their premises. The OdISSea Mission presented a remarkable opportunity for all involved teams to acquire an understanding of ISS operational processes and an experience in using new operational tools that were precursor to those used at present to support European Columbus payload operations.

Following OdISSea, the Cervantes mission was performed by Spain with the support of ESA between October 18th 2003 and October 28th 2003. During this mission, ESA astronaut Pedro Duque performed a large scientific programme (18 experiments, among which 6 Spanish and 7 Belgian, covering the same research fields as for OdISSea.). The Ground Segment made a reuse of the previously implemented infrastructure and B.USOC handled almost the same responsibilities during the operations. On the other hand, there were also some improvements: the operational team working at B.USOC also involved people from the SROC and from the Belgian MTM/KULeuven UHB Ground Operations/Telescience teams. B.USOC regarded this successful mission as a further opportunity to extend the know-how of the Belgian operational community.



Frank De Winne during the OdISSea mission in November 2002, operating the ESA Microgravity Science Glovebox inside the US module. (credit: NASA)

SOLAR & ASIM

Alice Michel and Nadia This

The next major development of the B.USOC happened in February 2008 when the European Columbus module was docked to the ISS. It carried, as an external payload, the SOLAR package constituted by three instruments monitoring the solar output from the extreme UV to the middle infrared. One of these experiments, SOLSPEC, has been developed by SA/CNRS and BIRA-IASB (see section "SOLSPEC", chapter 8).

B.USOC is Facility Responsible Centre (FRC) for the SOLAR payload. SOLAR was designed to operate for 18 months, with a possible mission extension by up to three years. After that, it should have been returned to Earth, but its smooth operation and flow of valuable data prompted the scientists to request an even longer mission. Based on good performance of the two remaining instruments (RMI/SOVIM stopped to work after a few months), the SOL-ACES and SOLSPEC science teams received an acceptance from NASA and ESA to extend the SOLAR mission up to end of February 2017.

Since 2012 winter solstice, a full solar rotation is observed at each solstice by making a slight change of the ISS attitude. After long negotiations, this is the first time that NASA accepts to modify the ISS attitude for a scientific objective. A very important contribution from the SOLAR 'bridging' measurements is the possibility it brings to perform intercomparisons over an entire solar rotation period with data from other solar instruments in orbit (e.g. a comparison of ESA's SOLAR - SOL-ACES data with NASA's SDO/EVE data). The bridging already shows that these particular datasets match extremely well with each other. This is an exciting time for the solar scientific team because the full solar rotation observation gives researchers a more complete dataset to work with for their studies on the impact of the sun's radiation on our planet's environment.

The next important external payload that B.USOC will manage is ASIM (Atmospheric Space Interaction Monitoring Instrument). ASIM is an ESA science instrument assembly to be flown on the Columbus External Payload Facility (CEPF) of the ISS (International Space Station). The launch is foreseen for early 2016.

The ASIM concept has been proposed by the Danish National Space Centre with the objective to observe Transient Luminous Events that occur in the Earth's upper atmosphere accompanied by thunderstorms in the lower atmosphere. These events are known as blue jets, sprites and elves, the phenomena were first observed in 1989. The ISS is considered a perfect platform from which to enhance our knowledge about them. ASIM is designed to be accommodated on the starboard deck location of the CEPF (Columbus External Payload Facility) platform. As for SOLAR, B.USOC will be the FRC for this project.



SOLAR/SOLSPEC Payload on ISS. (credit: NASA)

Space Pole

Consisting in three federal scientific institutions: The Royal Observatory of Belgium, the Royal Meteorological Institute and the Belgian Institute for Space Aeronomy.

PICARD

Michel Anciaux and Claudio Queirolo

The Sun and its impact on Earth's climate is a topic of prime importance for BIRA-IASB, and in a more generic way for the Space Pole, since a long time. The Picard mission for observing the Sun was proposed in 1998 by the Service d'Aéronomie of the Centre National de Recherche Scientifique (SA/CNRS, now LATMOS) and on 3 December 2004, the Centre National d'Études Spatiales (CNES) endorsed this project. The PICARD mission was named after the French astronomer of the 17th century Jean Picard who achieved the first accurate measurements of the solar diameter. These measurements are especially important as they were made during the Maunder minimum, a period characterized by an absence of sunspots and a significant cold climate.



The Payload Data Centre (PDC)
Comprises all ground segment elements related to payload data acquisition, processing, and dissemination and archiving. It also includes the user interface facilities which offer services to the user community.

The B.USOC PICARD team at the Toulouse Space Centre during the integration of the satellite.

PICARD is a CNES/ MYRIADE microsatellite sending back data needed to improve models used for forecasting solar activity. It was designed to take simultaneous measurements of parameters such as the speed at which the Sun rotates, the radiation it emits, the presence of sunspots and its shape and diameter; to help scientists understand the relationship between them. These models also help to evaluate the influence of the Sun on the dynamic chemical processes governing balances in the Earth's atmosphere. The Picard programme also has other objectives, namely to study the Sun's internal structure using helioseismology techniques and to analyse the impact of solar variability on the processes governing balances in Earth's atmosphere, notably the relationship between solar ultraviolet radiation and stratospheric ozone.

Initially scheduled for 2003, PICARD has been launched on 15th June 2010 at the start of the current solar cycle, on a scheduled three-year mission. The satellite provided simultaneous measurements of the solar diameter, differential rotation and solar constant to investigate the nature of their relations and variability. Since the PICARD launch, the payload data centre (CMS-P) is operated by the B.USOC. Concretely, this is the first time that the French space agency (CNES) decentralized operations for a MYRIADE microsatellite, the CMS-P is therefore an exception in the French microsatellite programme. The main responsibilities of the B.USOC are to program the payload according to the scientific objectives and the operational and technical requirements, to gather and analyse the payload-related housekeeping data, to process and distribute the raw and calibrated data. At the end of the mission in March 2015, after a period for massively reprocessing the data, the scientific products will be transferred to the IAS-MEDOC for long term archiving.

Selected Reference

Pradels, G., T. Guinle, G. Thuillier, A. Irbah, J. P. Marcovici, C. Dufour, D. Moreau, C. Noel, M. Dominique, T. Corbard, M. Hadjara, S. Mekaoui and C. Wehrli (2008), The PICARD Payload Data Centre, American Institute of Aeronautics and Astronautics, p. 3231.

MULTI-PURPOSE END-TO-END ROBOTIC OPERATION NETWORK TELEROBOTICS

Karim Litefti and Rachid Abjij

Since its establishment, planetology research (see chapter 13) has always been part of the scientific activities of the BIRA-IASB. Addressing the challenges related to space exploration, we improve our knowledge, our technology, creating new industries, and we help to create a peaceful setting with other nations. Before embarking on a long and difficult exploration programme, it is important to establish a very solid foundation for this business to be successful and the ISS is a vital component to achieve this. The ISS is a test bench and a springboard to the exploration of space beyond low Earth orbit and help to prepare planetary exploration and specifically through robotic approach.

METERON (Multi-Purpose End-To-End Robotic Operation Network) is an ESA-led international space project for advanced telerobotics technology demonstration involving the ISS. METERON will provide answers to how future exploration mission scenarios need to be designed, if crew is located in a planetary orbit (Moon, Mars, Asteroid, etc.) and how robots must be controlled in a planet or celestial body. To test various scenarios and to validate the related technologies, robots on Earth will be controlled from the interior of the ISS during the METERON project. Control devices will be force reflecting joysticks and arm exoskeletons.

The overall goal of METERON is to set up a simulation environment to allow ground controllers in a Control Centre or astronauts on ISS to be able to simulate robotic exploration scenarios tele-operating a robot located on the ground through the ISS environment.

This project has been assigned to B.USOC by ESA in 2012 as a preparation to future "planetary" operations at Space Pole and to capture know-how on new communications protocols such as the "Disruption/Delay Tolerant Networking (DTN)"

Several space agencies and institutions work together to achieve the goals of METERON, including ESA, NASA, ROSCOSMOS, ESOC, CU-Boulder and B.USOC. B.USOC tasks and responsibilities vary along the project phases, and focus on operational and ground support of activities conducted on board ISS.



Artist view of the METERON project concept and objective.

Disruption/Delay Tolerant Networking" (DTN):

The DTN program is a step toward building a reliable Interplanetary Internet. The experiment establishes a long-term communications test bed on the International Space Station (ISS), which transmits test messages between the ISS and ground stations. Delay- and disruption-tolerant networks can improve electronic communications by storing data when a connection is interrupted, and forwarding it to its destination using relay stations.

PREPARING THE LONG TERM SPACE DATA PRESERVATION

Christian Muller and Didier Moreau

Preserving scientific data is challenging for academic entities and government agencies given the tremendous volumes, sources, and types of satellite data potentially involved. To properly preserve data, you need the right tools and methods to ensure all potentially relevant data is captured and remains intact.

Knowledge Management: PERICLES

To apprehend this important challenge for the future, B.USOC decided to valorise his acquired expertise by providing data and operational expertise to several projects funded by the European Union under its Seventh Framework Programme (ULISSE, CUBIST, PERICLES).

PERICLES (Promoting and Enhancing Reuse of Information throughout the Content Lifecycle taking account of Evolving Semantics) aims to address the challenge of ensuring that digital content remains accessible in an environment that is subject to continual change. This can encompass not only technological change, but also changes in semantics, academic or professional practice, or society itself, which can affect the attitudes and interests of the various stakeholders that interact with the content. In this context, the International Space Station (ISS) is the most complex and powerful laboratory for research in space: its utilization concerns scientific disciplines ranging from Life to Physical Sciences as well as technology developments and offer perfect material to use for the development and implementation of new tools.

The PERICLES project uses SOLAR as its space case and has begun the inventory of the available SOLAR data through a snapshot of a period. These data include all documents produced during SOLAR operations, ancillary data and the entire science data stream. PERICLES will also archive the scientific data and products derived by the Principal Investigators from the raw data which B.USOC transfers to their UHB's. PERICLES takes a 'preservation by design' approach that involves modelling, capturing and maintaining detailed and complex information about digital content, the environment in which it exists, and the processes and policies to which it is subject. The project will deliver a preservation prototype, as well as a portfolio of models, services, tools and best practice for the support of preservation ecosystem and lifecycle management. Broader take-up of the project results will be encouraged through Communities of Practice and engagement with industry.

Selected References

Klaï, S., E. Sevinç, B. Fontaine, C. Jacobs, C. Muller (2012), CUBIST: Semantic Business Intelligence Supporting Payload Operations, in 12th International Conference on Space Operations, 11-15 June 2012, Stockholm, Sweden.

The Spot/Pléiades National Data Portal

In 2006, the Belgian and French government signed an additional clause to their initial agreement related to the participation of Belgium in the Spot Programme allowing Belgium to participate in the Pléiades programme as well. In this context, a distribution agreement has been signed between Spot Image (legal distributor of Pléiades data) and the Belgian Science Policy Office (Belspo).

The role of Belspo will be to manage large volumes of data, to provide easy access to an archive and to render the investments made by the Belgian Government profitable. In order to support Belspo achieving these goals, B.USOC offered a global solution to manage the archiving of Pléiades images.

The goal of this infrastructure developed at BIRA-IASB is to store the requested products (processed images) delivered by ASTRIUM and to redistribute these products to the user community (approved by the Belspo/Stereo management).

The "National Data Portal" developed by the B.USOC is a web interface allowing to display images and meta-data stored on the database. Authenticated users have the possibility to download these products. On top of that, a backup system has been developed to ensure the long term data preservation of the requested products.

Websites

B.USOC:
<http://www.busoc.be>

The BELGIAN Pléiades Portal:
<http://pleiades.busoc.be>

17



BELEGCH INSTITUUT VOOR RUIMTE-AERONOMIE (BIRA) INSTITUUT D'AERONOMIE SPATIALE DE BELGIQUE (IASB) BELGIAN INSTITUTE FOR SPACE AERONOMY (BIRA-IASB) BELGICH INSTITUUT VOOR RUIMTE-AERONOMIE (BIRA) INSTITUUT D'AERONOMIE SPATIALE DE BELGIQUE (IASB)

CONCLUSIONS AND PERSPECTIVES

Martine De Mazière, Johan De Keyser and Didier Fussen



Today, it is undeniable that the Belgian Institute for Space Aeronomy (BIRA-IASB) has evolved into a research institute with a considerable scientific potential (employing more than 85 researchers, most of them with a doctoral degree) and an established international research reputation. Its 50th anniversary is a good moment to reflect on its actual status, its strengths, its weaknesses and the forthcoming challenges.

The Institute has grown bottom-up, based on the initiatives and efforts of scientists, without strong guidance or limitations imposed by the Administration. The scientists have benefited from the necessary freedom in their choice of research topics and of their scientific collaborations, and from a large flexibility in the management of research projects. As the field of aeronomy expanded, the Institute has prospered. Its expertise encompasses a rather large diversity of research topics in atmospheric sciences and space physics. The growing numbers of application domains and the accompanying funding initiatives have led scientists towards a broad spectrum of applied science domains and services. Behind this diversity lie a limited number of key fundamental scientific competences.

This wide palette of expertise strengthens our capacity to adapt to changes in research orientations and programmes. It will be important in the future to maintain the **flexibility and capacity** to adapt to a changing research environment, including changes in the research subjects of strategic importance (e.g., the emergence of a strong focus towards climate and air quality studies) as well as changes in the partnerships (e.g., an increasing need for collaborations with the developing countries).

Still, the Institute remains small and it may need to enter into partnerships to acquire the critical mass needed to compete at the national or international level.

Aeronomy needs observations to advance. There are three types of measurements in which we excel. First, there are the **process-oriented experiments** carried out in the laboratory and accompanied by measurements in the field. Second, there is the **long-term monitoring of the atmosphere** that is crucial for the follow-up of the long-term changes in our environment, some of natural origin and some due to anthropogenic activities, and their impact on natural processes. Long-term monitoring is typically an activity to be maintained by the national governments. Nevertheless, the Institute's basic funding is marginally sufficient to maintain this very demanding activity. Additional funding is short-term and project-based. There is no specific recurrent budget line to support long-term monitoring, despite recommendations from high-level organizations like the Ozone Research Managers from the World Meteorological Organization.

A third area of expertise is in **observations from space**. The history of the Belgian Institute for Space Aeronomy demonstrates how strongly aeronomy research is coupled with space since the very beginning of the Institute. The scientists have been deeply involved in the development of instruments and missions, as well as in the processing and the validation of space data. But they also have to face the short-term nature of space missions and of the accompanying funding. For instance, the funding for research related to a space experiment generally stops quickly after the end of the mission, but at that time usually a lot of calibration, validation and re-processing work still remains to be done. There is often a lack of continuity in ESA missions in a given research domain, and it is hard to build or maintain core competences if one has difficulties to bridge funding gaps. The creativity of the Institute's scientists, however, has been able to find ways to deal with this reality, but in the current harsh economic conditions this is getting very difficult. A stronger impact of the Belgian State on space policy could be beneficial.

Observations imply instruments. Ground-based instruments must not only be maintained but also innovated as technology progresses. A good collaboration between the scientists setting the requirements and the engineers who design and build the instruments is of primary importance. For instruments flying on spacecraft, the cost and political complexity of ESA missions necessitate the formation of instrument consortia, with the attendant political complexities and requirements to find a role for Belgian industry. In the future the Institute hopes to capitalize on its expertise in optical instruments for atmospheric sounding and in mass spectrometry. An example of this strategic approach is to consider the demonstration of CubeSat missions such as PICASSO that might offer an independent capability to acquire useful scientific data from space. Another example is the development of compact optical remote sensing payloads for deployment on unmanned aerial vehicles. The Institute must maintain its **technological and engineering capabilities** if it wants to provide instruments as

Principal Investigator; and also if it wants to ensure a position in instrument consortia as Co-Investigator. This will require a further strengthening of its **partnerships** with industries, preferably Belgian industries, especially when thinking about satellite instruments.

Aeronomy also needs **theoretical studies and numerical simulations** of the radiative, physical and chemical processes in space and in the atmosphere, for acquiring a better understanding and to support the planning and the interpretation of the observations. Data assimilation has become a very powerful technique. The advances in knowledge, especially regarding the coupling between the different Earth system components, and the growth of data sets becoming available from satellite, with always higher spatial and temporal resolution, require a corresponding evolution of the models. They become extremely complex and demanding as to computer capacity. Also for this field of aeronomy research, consortia building is becoming more important.

A strong **IT support** for data management and high-performance computing is indispensable: this requires hardware investments, software development and experts' support! More investments are needed, and where feasible, common investments with external partners must be encouraged to enhance the cost-efficiency.

The expertise acquired by the Institute should be put at the disposal of the community – Belgian and international. This idea of “benefit for the citizen” is a bit ambivalent. Of course, there are the scientific publications and books that have been produced by the Institute's scientists, as well as the outreach activities for a larger public. But in addition, in some situations, an actual service can be developed that benefits the citizen or particular user communities. BIRA-IASB has set up such services (SACS volcanic ash monitoring system for aviation, the Space Situational Awareness Space Weather Coordination Centre ...) and it will support such activities in the future. Some of these services, however, might become very application oriented (with the application not necessarily belonging to the scope of BIRA-IASB's research) or possibly commercially oriented. In these cases, one should consider to spin-off such activities.

Next to national partnerships, and hopefully more opportunities for collaborations with Belgian universities in the near future, it remains important for BIRA-IASB to build and consolidate **partnerships at the international level**, with research organizations from abroad and with other space agencies. In the current international context, it is no longer essential to engage in partnerships with ESA only. It is natural also for institutes like BIRA-IASB to look for launch opportunities and participation in satellite experiments beyond ESA. This raises of course the question of the availability of Belgian funding and support for non-ESA missions or instruments.

The present financial situation, in which the Institute relies for more than 60% ⁽¹⁾ on external funding, is very demanding and hardly feasible in the long term. From the administrative point of view, it implies a need for extensive project management support. From the scientific point of view, it means that the Institute must remain competitive and win contracts at the international level to maintain its current level of activities. This stimulates **dynamism and progress** but endangers the freedom in research.

In the current programmatic context, in which more attention goes towards applied research with direct societal and economic impacts, this endangers the opportunities to maintain **fundamental research**. Nevertheless, basic research is absolutely essential as a precursor for future applied work! For example, there remain profound difficulties in the theory of plasmas, such as those encountered in the ionosphere, the magnetosphere, or the interplanetary medium. Also in the lower atmosphere, there are still very fundamental questions, e.g., about the gas-to-particle partitioning in the formation of secondary aerosol from isoprene, and the aerosol formation in clouds (aqueous phase processing) in which phase separation in aerosols, mobility, and surface adsorption processes play roles that are badly known up to now. BIRA-IASB scientists have been pioneers in addressing some of these aspects, but there is still a long way to go. It is worth noticing that fundamental research not only addresses well identified questions but it also targets more exploratory domains. Planetary aeronomy is a nice example, where even the presence of some minor gases in a planetary atmosphere has not yet been discovered or confirmed. From the experimental point of view, the development of new measurement principles is an important scientific field well beyond a simple technology demonstration. The question is whether the current science funding mechanisms still leave room for such fundamental research.

But even if fundamental research is required in itself, without a societal application pointing directly at the horizon, a fundamental research component remains essential even in the application- or service-oriented activities. A good example is climate change research. BIRA-IASB will certainly move forward in the direction of climate services because they are asked for by our society that is being faced with a changing climate. But it can deliver objective services only because it is and will remain involved in fundamental scientific research that is at the basis of these services. The monitoring databases collected through sustained monitoring, the current involvement in projects like the ESA Climate Change Initiative projects on ozone, greenhouse gases and aerosols, and in the precursor projects of the Copernicus Atmospheric Monitoring and Climate Services, are essential building blocks for the climate research and services that will be further developed at BIRA-IASB and at the Belgian federal level.

⁽¹⁾ In 2013: dotation + statutory personnel ~ 4,8 MEuro; external funding ~ 8 MEuro



The primary resource of BIRA-IASB is **human capital**. For many years, there was no dedicated curriculum in our universities for young scientists in the discipline of aeronomy, despite the fact that environmental issues and high-tech space applications rank high on today's political agenda. Therefore, the Institute was obliged either to attract experienced researchers from abroad, or to hire young Belgian scientists and to educate them itself. There existed a similar lack in the engineering studies in Belgium, with insufficient attention to aeronautics and space engineering.

To overcome this limitation, several members of BIRA-IASB have committed themselves to give **courses at universities** dedicated to certain aspects of aeronomy and space physics (U. Gent, KULeuven, UCL, VUB, ULB, ULg ...) and to attract PhD students to aeronomy-related studies. The creation of a "Master in Space Studies" programme has contributed to this effort as well.

The scientists and project engineers of BIRA-IASB should have the opportunity to evolve on a flexible career path. Typically, scientists and project engineers have to spend many years in a rather uncertain position, with their job depending on the success or failure of project applications. From those who can become statutory personnel, it is expected that they are ready to evolve from a pure scientific research position to a scientific research and management position, in which they commit themselves to international projects, to research management activities, and to participation in national and international scientific committees. At the same time, senior scientists should guide the younger contractual scientists to acquire new experience in subjects of current strategic importance and to build strong research careers that benefit the Institute as a whole.

In summary,

One can state that the Belgian Institute for Space Aeronomy is resolutely moving forward in a changing and challenging research environment, and it is ready to face these challenges with confidence and aim for excellence.



The realisations described in this publication wouldn't have been possible without the much appreciated help of the BIRA-IASB personnel, working for the institute from 1964 until now.

Abjij Rachid	Cambier Pascale	De Witte Hilde	Echim Marius	Granville José	Kochenova Svetlana	Middernacht Michael	Quaghebeur Bart	Stavrakou Trissevgeni	Vanlaethem-Meurée Nicole
Ackerman Marcel	Capouillez Nadège	Decaffmeyer L.	Egerickx Tom	Gunell Karl Nils Herbert	Kockarts Gaston	Mignon Philippe	Queirolo Claudio	Steegmans Albertine	Vansintjan Robbe
Aerts Emile	Cardoen Pepijn	Deceuninck Hilde	El Mahtouchi Abdelouadif	Hallet Stefaan	Kruglanski Michel	Minion Jean-Louis	Quevrin Cyril	Stegen Koen	Vastenaekel Edward
Ailliet Marc	Carnier André	Declercq Bart	Equeter Eddy	Haumont Etienne	Kumps Nicolas	Montmessin Franck	Ranvier Sylvain	Stevens François	Vastenaekel François
Amelynck Crist	Ceulemans Karl	Decuyper Jean-Pierre	Errera Quentin	Hautfenne Maurice	Ladrière Etienne	Moreau Didier	Raport Elien	Stockman Xavier	Verbracke Fabian
Anciaux Michel	Chabanski Sophie	Decuyper Willy	Falise Gabriel	Helderweirt Anuschka	Lambert Jean-Christopher	Morsa Nathalie	Rasson Olivier	Tack Frederik	Vercheval Jacques
Arijs Etienne	Chabrilat Simon	Degreef Gérald	Fally Sophie	Hemerijckx Geert	Lamoen Dirk	Mosselmans Livia	Rigo Edwin	Tetard Cédric	Vergison Emmanuel
Asscherickx Paul	Cherkani-Hassani Salima	Dejaeghere Roger	Fayt Caroline	Hendrick François	Lamy Hervé	Muller Alexis	Rimetz-Planchon Juliette	Theys Nicolas	Verhoelst Tijl
Baedewijns Robert	Christophe Yves	Dekemper Emmanuel	Fedullo Leonardo	Hennen Olivier	Langerock Bavo	Muller Christian	Riondato Jorgen	This Nadia	Verhoeven Caroline
Barret Pierre-Brice	Christophe Titouan	Delancker Marc	Ferrière Olivier	Hermans Christian	Lebon Harald	Müller Jean-François	Riquet Denis	Thomas Ian	Vermer François
Batteux Samuel	Clairquin Roland	Delanoye Sofie	Fontaine Bertrand	Hermant Claude	Leclère Fabienne	Neary Lori	Ristic Bojan	Thonnard Michèle	Verschueren Michiel
Bauwens Maite	Clemer Katrijn	Delgado Blanco Rosalia	Fonteyn Dominique	Hetey Laszlo	Lefebvre Arnaud	Neefs Eduard	Robert Charles	Thoré Raphaël	Verstrael J.
Belfiore Virginie	Compernelle Steven	Delhaisse Cathy	Fosse Christiane	Heymans Carine	Lefever Karolien	Nevejans Dennis	Robert Séverine	Valentin-Mortier Augusta	Verstraeten Jean-Claude
Berkenbosch Sophie	Coosemans Thierry	Delsart Yves	Foullon Claire	Heynderickx Daniel	Lemaire Joseph	Neven Joseph	Robyns Sophie	Van Bavel Anne-Marie	Vetsuyppers Liliane
Bernier Frédéric	Coremans François	Demarcke Marie	Franssens Ghislain	Hizette Christiane	Lemestre Anne	Nicolet Marcel	Roeland Serge	Van Belle René	Vigouroux Corinne
Bevernaegje Jessica	Cornelis Karin	Demol Jo	Fratta Stéphanie	Hochberg Louis	Lerot Christophe	Nisol Paul	Rosseeuw Marcel	Van Den Branden Didier	Villé Paul
Biaumé Freddy	Coszach Romuald	Demoulin Philippe	Frederick Pierre	Hoebers Ivan	Letocart Vincent	Noël Christian	Rouvas-Nicolas Catherine	Van Den Storme Christiane	Vismix Tim
Bijloos Geert	Counerotte Frédéric	Depiesse Cédric	Friedlingstein, Pierre	Hubert Hervé	Litefti Karim	Olamba Kalonda Paul	Sauvage M.	Van Der Ween Diane	Voeten Gilbert
Bingen Christine	Craenen Jozef	Dequae Philip	Frimout Dirk	Hubert Daan	Loodts Nicolas	Olemans Eric	Sayed Umar	Van Geffen Jos	Vogeleer Daisy
Bismuth Hervé	Crop Jean-Claude	Desmet Filip	Frolova Alexandra	Humbled Francois	Lopez Rosson Graciela	Olieslagers R.	Schadeck Serge	Van Gent Jeroen	Voytenko Yuriy
Bogaerts Brigitte	Crosby Norma	Detraux François	Fussen Didier	Hurtmans Daniel	Louwet Guido	Ooms Tim	Scherer Marc	Van Hemelrijck Etienne	Vranjes Jovo
Bolsée David	Cyamukungu Mathias	Devahive Nelly	Gabryl Jean-René	Hus Hervé	Maegh, Dirk	Op De Beek Marc	Schmidt Pierre	Van Kerckhoven Rudy	Wallens Sabine
Bonjean Stijn	Daerden Frank	Devalliers Pierre	Gaffé Dominique	Ingels Johan	Maes Jeroen	Orr Andrew	Schmitz Jacques	Van Opstal Albert	Walravens Bruno
Bonnewijn Sabrina	Danckaert Thomas	Dhooghe Frederik	Gamby Emmanuel	Iterbeke Philippe	Maes Lukas	Palange Jean	Schoon Niels	Van Ransbeeck Emiel	Wera Jan
Borremans Kris	Darrouzet Fabien	Dia Ablaye	Geenen Jos	Jacobs Peter	Maggiolo Romain	Pandey Praveen	Scolas Francis	Van Reeth Eduard	Weydert Tom
Botek Edith	De Baets Peter	Dierckxsens Mark	Gendarme Francine	Jacobs Tim	Mahieux Arnaud	Parmentier Noël	Segers M.	Van Roozendael Michel	Willame Yannick
Boyes John David	De Clercq Marguerite	Dierickx Louis	Gérard Pierre	Janssens Karen	Mann Ingrid	Pastiels Roger	Sente Jean-Marie	Vanbresse Luc	Willems F.
Brasseur Guy	De Clercq Coralie	Diez Bernard	Geuens Francine	Jaumin Maurice	Martinez Tarin Ana	Pauwels Dirk	Senten Cindy	Vanclooster Roger	Wilquet Valérie
Brenot Hugues	De Coninck Lucas	Dils Bart	Geuens Yves	Kabbadj Youssef	Massano Santos Cristina	Peeters William	Servais Christian	Vancraeynest Geert	Wisemberg Jacques
Breynaert Guido	De Donder Erwin	Dodion Jan	Gielen Clio	Kalb Nathalie	Mateshvil Nina	Peeters Philippe	Simon Arthur	Vandaele Ann Carine	Yu Huan
Brouckmans Kristien	De Keyser Johan	Domange Pol	Gillotay Didier	Karamitsos Jannis	Melanitis Dimitra	Pieck Gerry	Simon Cyril	Vandenbergh Jean-Marie	Zenner Nils
Brun Nicolas	De Mazière Martine	Dominique Marie	Ginoux Paul	Kennes Robert	Melikechi Abdenour	Pieroux Didier	Simon Paul	Vandenbussche Sophie	
Bulcke Johan	De Rudder Anne	Dricot Lione	Gloesener Elodie	Keppens Arno	Menssouri Jamal	Pierrard Viviane	Skachko Sergey	Vandergeten Liesbet	We apology for the few names who have been forgotten.
Cabrera Jamouille Juan	De Smedt Isabelle	Drowart Adrien	Godart Maurice	Kerzenmacher Tobias	Merlaud Alexis	Pieters Michaël	Skarlas Polymnia	Vanderpoorten Wim	
Cadez Vladimir	De Viron, Bruno	Drummond Rachel	Gottignies Maryse	Kindermans Heidi	Mertens Jeannine	Pinardi Gaia	Snellings Marielle	Vandreck Fernand	
Calders Stijn	De Wachter Evelyn	Dutrieue Brigitte	Gouget Hervé	Knockaert Luth	Messios Neophytos	Pitermann, Michel	Soebijanta Vincent	Vanhamel Jurgen	
Callebaut Hans	De Wilde H.	Dymek Maria	Govers Marie-Paule	Kochchif Mustapha	Meuris Peter	Plaisant David	Somers Tim	Vanhaverbeke Jérémie	
					Meuwis M.	Pokorni Françoise	Speelman Erik	Vanhellemont Philip	
					Michel Alice	Puttemans Kevin	Stapelle Maxime	Vanhoutte Dimitri	
							Stassin Roseline		

ACRONYMS

3DEES	3 Dimensional Energetic Electron Spectrometer	CME	Coronal Mass Ejection	ESA	European Space Agency	HITRAN	High-resolution TRansmission molecular Absorption
4D-VAR	4 Dimensional VARiational	CMOS	Complementary Metal–Oxide–Semiconductor	ESOC	European Space Operations Centre	HP	Hewlett-Packard
ACE	Atmosphere Chemistry Experiment	CMS-P	Centre de Mission Scientifique Picard	ESRO	European Space Research Organization	hPa	hectoPascal
ACE-FTS	Atmosphere Climate Experiment - Fourier Transform Spectrometer	CNES	Centre Nationale d'Etudes Spatiales	ESWeP	European Space Weather Portal	HPC	High Performance Computing
AERONET	Aerosol RObotic NETwork	CNRS/LATMOS	Centre National de la Recherche Scientifique / Laboratoire Atmosphères Milieux Observations Spatiales	EU	European Union	HRSC	High Resolution Stereo Camera
AIRS	Atmospheric InfraRed Sounder	COMESA	Committee on the Meteorological Effects of Stratospheric Aircraft	EUMETSAT	EUropean organisation for the exploitation of METeorological SATellites	IAP/CAS	Institute of Atmospheric Physics at the Chinese Academy of Sciences
ALAE	Atmospheric Lyman-Alpha Emissions	COMSESP	COronal Mass Ejections and Solar Energetic Particles	EURECA	European Retrievable Carrier	IASI	Infrared Atmospheric Sounding Interferometer
ALIS	Auroral Large Imaging System	COSPAR	COmmittee of SPACE Research	EUV	Extreme UltraViolet	IAS-MEDOC	The Institut d'Astrophysique Spatiale - Multi-Experiment Data Operation Centre
ALTIUS	Atmospheric Limb Tracker for Investigation of the Upcoming Stratosphere	COST	COoperation in Science and Technology	EXOMars	EXObiology on Mars	IGOS	Integrated Global Observing Strategy
AMABEL	Astronomie Meteorologie Aeronomie België	COVOS	COmte d'etudes sur les consequences des VOls Stratospheriques	FA	Flowing Afterglow	IGS	Interconnection Ground Subnetwork
AMOS	Advanced Mechanical and Optical Systems	CPM	Chimie Physique Moléculaire (of the Université Libre de Bruxelles)	FAA	Federal Aviation Administration	IGY	International Geophysical Year
AMPTE/IRM	Active Magnetospheric Particle Tracer Explorer / Ion Release Module	CRISTA	Cryogenic Infrared Spectrometers and Telescopes for the Atmosphere	FA-SIFT	Flowing Afterglow - Selected Ion Flow Tube	IMAGE	Imager for Magnetopause-to-Aurora Global Exploration
AOD	Aerosol Optical Depth	CROSTVOC	CROp STress VOC	FA-TMS	Flowing Afterglow - Tandem Mass Spectrometer	IMAGES	Intermediate Model fo the Annual and Global Evolution of Species
AOES	Atos Origin Engineering Services	CRRES	Combined Release and Radiation Effects Satellite	FFT	Fast Fourier Transform	IMEC	Interuniversity Microelectronics Centre
AOTF	Acousto-Optical Tunable Filter	CSL	Centre Spatial de Liège	FMI	Finnish Meteorological Institute	IMPECVOC	IMPact of Environmental Conditions and phenology on bVOC emissions from forest ecosystems
APOLLO	America's Program for Orbital and Lunar Landing Operations	CSR	Center for Space Radiations	FNRS	Fonds National de la Recherche Scientifique	INTA	Instituto Nacional de Tecnica Aeroespacial
ASIM	Atmospheric Space Interaction Monitoring Instrument	CUBIST	Combining and Uniting Business Intelligence with Semantic Technologies	FP7	Framework Project 7	IO3C	International Ozone Commission
ATLAS	Atmospheric Laboratory for Applications and Science	CU-Boulder	Colorado University - Boulder	FPGA	Field Programmable Gate Arrays	IPCC	Intergovernmental Panel on Climate Change
AU	Astronomical Unit	DAM	Digital and Absorber Modules	FRC	Facility Responsible Centre	IPY	International Polar Year
AWDA Net	Automatic Whistler Detector and Analyzer Network	DFMS	Double Focusing Mass Spectrometer	FRFC	Fonds de la Recherche Fondamentale Collective	IR	InfraRed
B.USOC	Belgian User Support and Operations Centre	DLR	Deutsches zentrum für Luft- und Raumfahrt	FRIPON	Fireball Recovery and InterPlanetary ObservatioN	IRGW	InfraRed Working Group
BALLAD	BALloon Limb Aerosol Detection	DMSP	Defense Meteorological Satellite Program	FT	Fourier Transform	ISDN	Integrated Services Digital Network
BASCOE	Belgian Assimilation System for Chemical ObsErvations	DOAS	Differential Optical Absorption Spectroscopy	FTIR	Fourier Transform InfraRed	ISEE	International Sun-Earth Explorer
Belpo	Belgian science policy	DTM	Drag Temperature Model	FWO	Fonds Wetenschappelijk Onderzoek	ISS	International Space Station
BIC	Balloon Intercomparison Campaign	DTN	Disruption/Delay Tolerant Networking	GAIA	Global Astrometric Interferometer for Astrophysics	ISSJ	International Scientific Station of the Jungfraujoch
BIRA-IASB	Belgisch Instituut voor Ruimte Aeronomie - Institut d'Aéronomie Spatiale de Belgique	EASOE	European Arctic Stratospheric Ozone Experiment	GAW	Global Atmosphere Watch	IUP	Institut für Umweltphysik
BOIC	Balloon Ozone Intercomparison Campaign	EC	European Commission	GCM	General Circulation Model	K	Kelvin
BRAMS	Belgian RAdio Meteor Stations	ECC	Electrochemical Concentration Cell	GCOS	Global Climate Observing System	KeV	Kilo electron volt
BTX	Benzene Toluene Xylene	ECMWF	European Center for Medium Range Weather Forecast	GDP	Gome Data Processor	KNMI	Koninklijk Nederlands Meteorologisch Instituut
BUV/SBUV	Backscatter UltraViolet / Solar Backscatter UltraViolet radiometer	ECV	Essential Climate Variables	GEISA	Gestion et Etude des Informations Spectroscopiques Atmosphériques	KUL	Katholieke Universiteit Leuven
BVOC	Biogenic Volatile Organic Compound	EDM	Entry, Descent and Landing Demonstrator Module	GEM	Global Environmental Multiscale model	LATMOS	Laboratoire Atmosphères, Milieux, Observations Spatiales
CAD	Computer Aided Design	EGSE	Electrical Ground Support Equipment	GEOS-Chem	Goddard Earth Observing System-Chemical	LEDA	Linear Electron Detector Array
CALIPSO	Cloud-Aerosol Lidar and Infrared Pathfinder Satellite Observations	EISCAT	European Incoherent SCATter Radar	GEOS	Global Earth Observation of SystemS	LIDAR	Light Detection and Ranging
CAM	Computer Aided Manufacturing	ELDO	European Launcher Development Organization	Gev	Giga electron volt	LNO	Limb, Nadir and Occultation
CAMS	Copernicus Atmospheric Monitoring Service	EMTGO	ExoMars Trace Gas Orbiter	GMES	Global Monitoring for Environment and Security	LOA	Laboratoire d'Optique Atmosphérique
CASYMIR	CAlibration SYstem for the Mass spectrometer Instrument Rosina	ENVISAT	ENVironmental SATellite	GNSS	Global Navigation Satellite System	Ls	Martian solar longitude
CCD	Charge-Coupled Device	EORCU	European Ozone Research Coordinating Unit	GOME	Global Ozone Monitoring Experiment	LSGC	Least-Squares Gradient Computation
CCI	Climate Change Initiative	EOS Aura	Earth Observing System Aura	GOMOS	Global Ozone Monitoring by Occultation of Stars	MACC	Monitoring Atmospheric Composition and Climate
CEPF	Colombus External Platform Facility	EPF	Emission Phase Function	GOSAT	Greenhouse gases Observing SATellite	MACSIMS	Measurement of Atmospheric Constituents by Selective Ion Mass Spectrometry
CESM	Community Earth System Model	EPT	Energetic Particle Telescope	GPS	Global Positioning System	MAESTRO	Measurement of Aerosol Extinction in the Stratosphere and Troposphere Retrieved by Occultation
CFC	ChloroFluoroCarbon	ER-2	Earth Resources 2	GRUAN	Gcos Reference Upper Air Network	MAP/GLOBUS	Middle Atmosphere Program: GLOBal BUDget of Stratospheric trace constituents
CHARM	Contemporary physical challenges in Heliospheric and AstRophyscial Models	ERBS	Earth Radiation Budget Satellite	GSFC	Goddard Space Flight Center	MAREMF	MARtian Electrons and Magnetic Field
CIAP	Climatic Impact Assesment Programme	ERS	Earth Remote Sensing	GSTP	General Support Technology Programme	MarsREM	Martian Radiation Environment Models
CIMS	Chemical Ionization Mass Spectrometry	ERS-2	European Remote-Sensing 2	HALOE	HALogen Occultation Experiment		
CIS	Cluster Ion Spectrometry			HDF	Hierarchical Data Format		

MAVEN	Mars Atmosphere and Volatile Evolution	PERICLES	Promoting and Enhancing Reuse of Information throughout the Content Lifecycle taking account of Evolving Semantics	SOLSPEC	SOLar SPECTrum	UNFOCCC	United Nations Framework Convention of Climate Change
MAXDOAS	Multi Axis Differential Optical Absorption Spectroscopy	PET	Proton/Electron Telescope	SOLSTICE	SOLar STellar Irradiance Comparison Experiment	UNIVAC/Convex/SGI	UNIversal Automatic Computer/ Convex Computer Corporation / Silicon Graphics Inc.
MBB/ERNO	Messerschmitt-Bölkow-Blohm/ EntwicklungsRing NOrd	PFS	Planetary Fourier Spectrometer	SORCE	SOLar Radiation and Climate Experiment	UT	Universal Time
METERON	Multi-purpose End-To-End Robotic Operation Network	PI	Principal Investigator	SOSP	SOLar SPECTrum (SOSP twin instrument)	UV	UltraViolet
MetOp	METeorological Operational satellite Program	PICASSO	Pathfinder Instruments for Cloud and Aerosol Spaceborne Observations	SOVIM	SOLar Variable and Irradiance Monitor	UV-Vis-NIR	Ultraviolet-Visible-Near Infrared
MeV	Mega electron Volt	POAM III	Polar Ozone and Aerosol Measurement III	SPENVIS	SPEctroscopy for Investigation of Characteristics of the Atmosphere of Mars	UVVISWG	UV-Visible Working Group
MEX	Mars EXpress	POCC	Payload Operation Control Center	SPENVIS-NG	SPENVIS Next Generation	V-2	Vergeltungswaffe 2
MHD	MagnetoHydroDynamic	POEM	Polar-Orbiting Earth-observation Mission	SPICAM	SPectroscopy for Investigation of Characteristics of the Atmosphere of Mars	VAAC	Volcanic Ash Advisory Center
MHz	MegaHertz	PPF	Polar PlatForm	SPICAM-E	stellar part of the instrument	VCD	Vertical Column Densities
MIPAS	Michelson Interferometer for Passive Atmospheric Sounding	PROBA	Project for On-Board Autonomy	SPICAM-S	solar part of the instrument	VDF	Velocity Distribution Functions
MIRAS	Microwave Imaging Radiometer with Aperture Synthesis	PSC	Polar Stratospheric Cloud	SPICAV	SPectroscopy for Investigation of Characteristics of the Atmosphere of Venus	VINTERSOL	Validation of INTernational Satellites and study of Ozone Loss
MLS	Microwave Limb Sounder	PTB	Physikalisch-Technische Bundesanstalt	SPOT-4	Satellite Pour l'Observation de la Terre 4	VISION	Visible Spectral Imager for Occultation and Nightglow
MLT	Magnetic Logic Time	PTR-MS	Proton Transfer Reaction Mass Spectrometer	SRON	Stichting RuimteOnderzoek Nederland	VITO	Vision on TechnOlogy
MOZART	Model for OZone And Related chemical Tracers	QI	Quality Indicator	SSA	Space Situational Awareness	VOC	Volatile Organic Compound
MPIK	Max-Planck-Institut für Kernphysik	QUILT	QUantification and Interpretation of Long-Term uv-vis observations of the stratosphere	SBUV	Solar Backscatter Ultraviolet Spectrometer	VUB	Vrije Universiteit Brussel
MSC	Meteorological Service of Canada	RAPID	Research with Adaptive Particle Imaging Detectors	SSBUV	Shuttle Solar Backscatter Ultraviolet Spectrometer	WACCM	Whole Atmosphere Chemistry-Climate Model
MSFC	Marshal Space Flight Center	REMSIM	Radiation Exposure and Mission Strategies for Interplanetary manned Missions	SSCC	Ssa Space weather Coordination Centre	WHISPER	Waves of High frequency and Sounder for Probing of Electron density by Relaxation
MSIS	Mass Spectrometer - Incoherent Scatter	RMI/SROC	Royal Meteorological Institute Space Remote Operation Center	SST	SuperSonic Transport	WMO	World Meteorological Organisation
MY	Martian Year	ROSINA	Rosetta Orbiter Spectrometer for Ion and Neutral Analysis	STAFF	Spatio-Temporal Analysis of Field Fluctuations	XUV	X-ray and extreme UltraViolet
NASA	National Aeronautics and Space Administration	SA/CNRS	Service d'Aéronomie / Centre National de la Recherche Scientifique	STCE	Solar Terrestrial Center of Excellence		
NCAR	National Center for Atmospheric Research	SACS	Support to Aviation Control Service	STS	Space Transportation System		
NCSR	National Center for Space Research	SAGE	Stratospheric Aerosol and Gas Experiment	SUSIM	Solar Ultraviolet Spectral Irradiance Monitor		
NDACC	Network for the Detection of Atmospheric Composition Changes	SAM	Stratospheric Aerosol Measurement	SWENET	Space Weather European NETwork		
NDSC	Network for the Detection of Stratospheric Changes	SAMPEX	Solar, Anomalous, and Magnetospheric Particle Explorer	SWING	Small Whiskbroom Imager for Atmospheric composition monitoring		
NILU	Norsk Institutt for Luftforskning	SAOZ	Système D'Analyse par Observations Zénithales	TANSO-FTS	Thermal And Near infrared Sensor for carbon Observation - Fourier Transform Spectrometer		
NIR	Near InfraRed	SBUV	Solar Backscatter UltraViolet radiometer				
NOAA	National Oceanic and Atmospheric Administration	SCIAMACHY	SCanning Imaging Absorption spectrometer for Atmospheric CHartography				
NOMAD	Nadir and Occultation for MArS Discovery	SCISAT	SCience SATellite	TCCON	Total Carbon Column Observing Network		
NORS	Network Of ground-based Remote Sensing	SDO/EVE	Solar Dynamics Observatory Euv Variability Experiment	TEMIS	Tropospheric Emission Monitoring Internet Service		
NSBF	National Scientific Balloon Facility	SEP	Solar Energetic Particle	TGE	The Great Escape		
NWP	Numerical Weather Prediction	SEPEM	Solar Energetic Particle Environment Modelling	TGO	Trace Gas Orbiter		
O ₃ M SAF	Ozone Monitoring Satellite Application Facility	SESAME	Second European Stratospheric Arctic and Mid-latitude Experiment	THESEO	Third European Stratospheric Experiment on Ozone		
OCIO	Office of the Chief Information Officer	SI	Système international d'unités	TIE-GCM	Thermosphere-Ionosphere-Electrodynamics General Circulation Model		
OCO	Orbiting Carbon Observatory	SIFT	Selected Ion Flow Tube	TIR	Thermal InfraRed		
OGO	Orbiting Geophysical Observatory	SLIMCAT	Single Layer Isentropic Model of Chemistry And Transport	TOA	Top of Atmosphere		
OIP	Optique et Instruments de Précision	SLP	Sweeping Langmuir Probe	TOMS	Total Ozone Mapping Spectrometer		
OMI	Ozone Monitoring Instrument	SME	Solar Mesosphere Explorer	TREND	Trapped Radiation ENvironment Development		
ONERA	Office National d'Études et de Recherches Aéropatiales	smog	smoke/fog	TSI	Total Solar Irradiance		
ORA	Occultation RAdiometer	SO	Solar Occultation channel	UARS	Upper Atmosphere Research Satellite		
ORB-KSB	Observatoire Royal de Belgique - Koninklijke Sterrenwacht van België	SOA	Secondary Organic Aerosols	UAV	Unmanned Aerial Vehicles		
OSIRIS	Optical Spectrograph and Infrared Imaging System	SOCRATES	Space Optical Communications Research Advanced Technology Satellite	UCL	Université Catholique de Louvain		
PAR	Photosynthetically Active Radiation	SOHO	Solar and Heliospheric Observatory	UFTIR	Upper free troposphere observations from a european ground-based FTIR network		
PBL	Planetary Boundary Layer	SOIR	Solar Occultation in the Infrared	UHB	User Home Base		
PCDF	Protein Crystallization Diagnostics Facility	SOL/-ACES	SOL-Auto-Calibrating Extreme ultraviolet and ultraviolet spectrometerS	ULB	Université Libre de Bruxelles		
PDC	Payload Data Centre			ULg	Université de Liège		
				UNEP	United Nations Environment Programme		

DESIGN Geluck, Suykens and Partners
PRINT Paperland

Brussels, November 2014
D/2014/678/1

Science is moving from one astonishment to another. Aristoteles

